

Dhananjayrao Gadgil Library



GIPE-PUNE-027677

**AGRICULTURE**  
**THEORETICAL AND PRACTICAL**

*"Divini Gloria Ruris."*

J.

E5

27677



# AGRICULTURE

THEORETICAL AND PRACTICAL

A TEXTBOOK OF MIXED FARMING FOR LARGE  
AND SMALL FARMERS AND FOR  
AGRICULTURAL STUDENTS

BY

JOHN WRIGHTSON, M.R.A.C., F.C.S.

AUTHOR OF "SHEEP AND THEIR MANAGEMENT", "FALLOW AND FODDER CROPS",  
ETC.; LATE PRESIDENT OF THE COLLEGE OF AGRICULTURE, DOWNTON, AND  
PROFESSOR OF AND EXAMINER IN AGRICULTURE TO THE SCIENCE AND ART  
DEPARTMENT; HONORARY PROFESSOR IN THE ROYAL AGRICULTURAL  
COLLEGE, CIRENCESTER; SPECIAL CROP REPORTER TO  
"THE TIMES", ETC., ETC.

AND

J. C. NEWSHAM, F.L.S.

PRINCIPAL OF THE MONMOUTHSHIRE AGRICULTURAL INSTITUTION; LATE PRINCIPAL  
OF THE HAMPSHIRE COUNTY COUNCIL AGRICULTURAL INSTITUTE, AND COUNTY  
LECTURER IN AGRICULTURE; CHAIRMAN OF THE DAIRY EDUCATION  
ASSOCIATION; EDITOR OF "DAIRYING AND DAIRY FARMING"; AUTHOR  
OF "THE HORTICULTURAL NOTE BOOK", "PROPAGATION AND  
PRUNING", "AGRICULTURAL ARITHMETIC", "AGRI-  
CULTURISTS' DIARY", ETC., ETC.

WITH AN INTRODUCTION BY THE  
RIGHT HON. THE EARL OF NORTHBROOK



LONDON :

CROSBY LOCKWOOD AND SON  
7 STATIONERS' HALL COURT, LUDGATE HILL, E.C.  
and 5 BROADWAY, WESTMINSTER, S.W.

1915

J  
E5

27677

**HERTFORD**

**STEPHEN AUSTIN AND SONS, LIMITED**

## INTRODUCTION.

I COMPLY very willingly with the request of Professor Wrightson and Mr. Newsham, that I should write a few lines of introduction to their textbook on *Agriculture, Theoretical and Practical*.

It may be said, and with some force, that there is no lack of manuals and other excellent works on the subject already in existence, but, while it is easy to obtain exhaustive information on some one phase of farming practice, and on the sciences affecting it, there are few, if any, up-to-date textbooks holding precisely the position this book is intended to fill.

A technical manual on the theory or practice of agriculture, designed with a definite aim, may fill two very useful and necessary functions; namely, those connected with the instruction of pupils at Agriculture Colleges, Farm Schools, or similar institutions, and those attached to a book of reference which the farmer or small-holder may consult, when, from time to time, he is in need of advice based on practical experience and scientific knowledge. The school purpose and the farm purpose, though allied, are quite distinct, and it is the aim of the authors to provide a book that will serve both.

There is another reason for hoping that such a book will find a place both in the classroom, and the houses of small as well as the large farmers.

We are just at the beginning of a great movement in agricultural matters. Small-holdings may be expected to increase in number in suitable districts, and Farm Institutes, under the encouragement of the Board of Agriculture and financial support from the Development Fund, will no doubt spread over the country.

These Institutes will find an important place in our educational system, and become the training-ground of the young farmer, and may be expected in the future to cater for a large and increasing number of the sons of smaller farmers, that is those farming from 50 to 200 acres of land.

Undoubtedly the coming years must see more and more of an organized system of education and greater attention paid to the thoughtful treatment of the land if it is to provide a living to those engaged in its cultivation, and this can only be secured by the application of exact knowledge: sound practice and reliable theory.

This book is also eminently suggestive as to the best methods of applying science to practice. It lays stress upon many problems which are destined to produce far-reaching consequences on fertility, land cultivation, and rural economy. The subjects treated are very numerous, and include, not only cultivation, but such important matters as farm-buildings, book-keeping, and the relative merits of grass and arable land. To give in a textbook such as this, which is necessarily restricted in size, an idea of farming matters in general, and to provide precise and reliable information on the cultivation and treatment of land, labour, machinery, live stock, dairying, and the many subjects connected with the industry of agriculture, is not an easy undertaking.

The authors may claim to have exceptional qualifications for the task. Professor Wrightson, who was for so long a period associated with Downton Agricultural College, has established for himself a wide reputation as a sound and practical farmer, while Mr. J. C. Newsham most successfully filled the post of head master of the Hampshire Farm School and County Lecturer on Agriculture for many years. Both authors may therefore be considered to possess not only the necessary scientific and practical knowledge, but to have had long experience in the needs of agricultural students and small farmers, and in imparting information in a form that is clear, concise, and attractive.

Although I have for many years taken an interest in the subject of farming, I lay no claim to the position of an expert, and I must leave this book to speak for itself, feeling confident that it will prove successful in meeting the needs of those for whom it has been written.

NORTHBROOK.

## PREFACE.

THE title of this book may appear ambitious, but has been well considered by the authors. Their object has been to present a concise view of the Practice of Agriculture, both from an extensive and an intensive point of view.

Much has been written of late years upon the comparative merits of large and small farming, and the suitability of the land of this country for the cultivation of vegetables, fruit, and flowers, rather than of corn or grass. Market-gardening has encroached upon ordinary farming, but it is also true that various forms of perishable produce have attracted the attention of extensive farmers—so that fruits and vegetables are now found side by side with corn and roots, live stock and dairying.

There are, however, well-defined limits as to soil and situation; for, as a rule, the cultivation of the more or less perishable crops is confined to good land, in close proximity to markets; while that of corn is largely pursued upon thinner and poorer soils, in more remote districts. There is room for both, and they must not be considered as antagonistic. Dairying occupies a middle position, for it may take the form of retail milk selling, wholesale dispatch of milk to a distance, or cheese- and butter-making, according to locality.

It will be found that each of these aspects is considered in the following chapters, and that the entire work is divided into sections dealing successively with the Soil, Agricultural Crops, Manures, Live Stock, Dairying, Horticulture, Market-gardening, Poultry, Rabbits, and Bees.

As to what is usually called theory or science, this volume does not pretend to be a manual of chemistry, nor yet of biology; neither does it profess to treat of everything. It was felt by the authors that there are abundant sources of

information of an expert character on all branches of agricultural knowledge, and that they would be placing themselves in a false position if they attempted to deal, as experts, with certain topics of undoubted interest. They therefore confined themselves to things of which they had practical knowledge, and upon which they could write with confidence, if not with authority. The boundaries between theory and practice are, however, by no means clear, and, in certain cases, they have consulted first-hand authorities upon such matters as bacterial life, nitrification, heredity, and Mendelism, in order to show the bearings of these subjects upon the practices of agriculture and stock-breeding—not to say of cheese- and butter-making. Sections will also be found on diseases, and plant-life, in which the treatment is meant to be practical, or to bear upon the necessary conditions for success.

Viewed as a textbook for examinations, this book will be found suggestive rather than exhaustive, and will, it is hoped, open the mind of students to many problems involved in practice, and sometimes obscured by technicalities. There has of late years been a marked approach on the part of agricultural scientists to the teachings of practice, i.e. in such things as the importance of water and mechanical processes (tillages) as affecting the entire economy of plant-life. The chemical composition of soils, which was at one time thought to be the secret of fertility, is now relegated to its proper position, as only one among many of the necessary conditions. So is it with the composition of plants and foods, for they also are found to vary with the circumstances under which they are produced, rather than the species to which they belong.

Farmers, as a body, have recognized the incongruity between the teachings of science and the results of practice, and consequently have sometimes regarded theorists somewhat coldly. All this is, however, changing, or has already changed, now that the leading chemists look upon rainfall and tillage as of primary importance, even from a theoretical standpoint. Perhaps this change is more apparent than real; but it cannot be denied that in recent writings of a scientific kind greater attention is bestowed upon what the farmer has always felt to be the essentials of his art.

Take, for example, the relations of block geology to agriculture. That they are important no one will deny, but closer inspection has shown that surface geology is the principal point, and that surface-maps are infinitely more useful than predictions as to the character of a soil based upon the main formation of the district. So, also, may be regarded the increasing attention to rainfall; to means of eradicating weeds; to root action on the subsoil; to the effects of tillage upon soil exhaustion; to dry farming; and many other topics occupying the following pages.

It is felt by the authors that great changes and great improvements are imminent, such as the cheapening of nitrates, the combating of plant diseases, the introduction of sugar-beet, and possibly of tobacco; intensive cultivation, the production of new varieties, applications of electricity, the making of artificial soils, etc. New vistas are opening out, and it is necessary that farmers should be alive to them. One great hindrance to the progress of scientific agriculture is the enormous area of inferior grass, and the time-honoured custom of leaving land down in sainfoin, or old, and temporary pastures, instead of actively cultivating it. It is, after all, an economical question; but the system is being steadily encroached upon, and is, no doubt, destined to disappear. The question which cannot be avoided in all such cases is, "Will it pay?" and there is too much disposition on the part of social writers to look upon food-production as a "duty". It is not a duty, but a means of livelihood; and can only be stimulated (apart from increased knowledge) by a sense that it is profitable to the cultivator himself. No one can be expected to produce food for the nation on philanthropic grounds; and this is the underlying reason why we see extensive tracts lying waste, subjected to a low type of cultivation. It is the object of this book to show in what directions improvement can be effected and extended.

Lastly, it will be observed that the student is constantly urged to make use of his own powers of observation instead of relying too much upon books and lectures. He is advised to watch the processes of germination of seeds for himself; to take apart and re-assemble the parts of implements; to frequent markets and notice the prices offered for different classes of live stock; to visit agricultural and poultry shows, and, if possible, to spend

## PREFACE.

some time with poultry farmers, fruit growers, and those who devote themselves to the cultivation of flowers or of fruit for market. Attention is also directed to the most approved methods of packing fruits and flowers for market. The work is illustrated with a special view to enabling the student or beginner to practise his art, and he is continually reminded of the importance of seeing how things are done and doing them, as well as of reading *about* them.

The authors desire to acknowledge the kindness of Messrs. Cooper and Nephews, of Berkhamstead, in supplying illustrations of live stock ; their thanks are also due to Messrs. Sutton & Sons, Reading, for illustrations of grasses and clovers ; and to Messrs. Garton, Warrington, for photographs of plant breeding. They would also thank the many manufacturers, illustrations of whose machinery and implements are reproduced in this book.

JOHN WRIGHTSON.  
J. C. NEWSHAM.

27677



# CONTENTS.

	PAGE.
INTRODUCTION . . . . .	v
PREFACE . . . . .	vii

## PART I.

### *SOILS, MANURES, AND CROPS.*

#### CHAPTER I.

##### ORIGIN, COMPOSITION, AND DISTRIBUTION OF SOILS.

Origin.—Formation of Soils.—Composition of Soils.— Ultimate Composition of Soils.—Soil Analysis.—The Constitution of the Soil.—The Colloids in Clay.—Life within the Soil.—Physical Properties of Soils.—Dis- tribution of Soils.—Classification of Soils.—The Subsoil . . . . .	1
---	---

#### CHAPTER II.

##### AIR AND WATER.

Climate.—Weather and Climate.—Reasons for our Un- certain Weather.—Aspect.—Shelter . . . . .	28
---	----

#### CHAPTER III.

##### TILLAGE AND PHYSICAL IMPROVEMENT.

Ordinary Tillage Operations.—The Future of Tillage.—Dry Farming.—Fallows and Fallow Crops.—General Remarks.—Fertilizers . . . . .	34
---	----

## CONTENTS.

## CHAPTER IV.

## GENERAL MANURES.

	PAGE.
Farm-yard Manures. — Composts. — Seaweed. — Waste Products.—Green-crop Manuring.—Guanos . . . . .	56

## CHAPTER V.

## SPECIAL MANURES.

Nitrogen and Nitrates.—Nitrate of Soda.—Sulphate of Ammonia.—Nitrate of Lime.—Calcium Cyanamide.—Phosphoric Acid and Phosphates.—Superphosphates.—Potash. — Soda. — Salt. — Gypsum. — Lime. — Ground Lime. — Unit Values of Manures. — Food Residues . . . . .	69
--	----

## CHAPTER VI.

## ROTATIONS OF CROPS.

Theory of Rotations. — Continuous Cropping. — Two, Three, Four, Five, and Six-year Rotations.—The Wiltshire Eight-course Rotation.—Modifications of Rotations, etc.—Catch-cropping . . . . .	91
--	----

## CHAPTER VII.

## CEREAL CROPS.

Origin of Cereal Crops.—Species and Varieties.—Their Exhausting Effects. — Continuous Corn-growing. — Wheat and its Cultivation.—Harvesting Cereals.—Barley. — Oats. — Comparison for Profit. — Barley Cultivation.—Oat Cultivation.—Winter Oats.—Rye . . . . .	96
---	----

## CHAPTER VIII.

## ROOT CROPS.

Fallowing Effects.—Position of Potatoes.—Potato Cultivation.—Early Potatoes.—Spraying Potatoes.—Mangel
--

CONTENTS.

xiii

	PAGE.
Wurzel.—Importance of Hoeing Root Crops.—Storing Mangel.—Storing other Root Crops.—Sugar-beet.—Swede Cultivation. — White and Yellow Fleshed Turnips.—Seasons for Sowing.—Carrots and Parsnips	111

CHAPTER IX.

FODDER CROPS.

Kohlrabi.—Cruciferous Fodder Crops.—Cabbages.—Kale.—Rape.—White Mustard.—Growing Root Crops for Seed. — Non-cruciferous Fodder Crops. — Vetches. — Trifolium. — Red Clover. — Alsike, White, Yellow Clovers.—Lucerne.—Sainfoin.—Maize.—Comfrey	132
--	-----

CHAPTER X.

GRASSES, MISCELLANEOUS PLANTS, AND WEEDS.

Cultivated Grasses.—The Fodder Cereals.—Rotation Grasses.—Mixtures of Grasses and Clovers.—Hay Seeds.—Laying down Land to Permanent Pasture.—Effect of Management on Grass Land.—Migration of Seeds.—Effect of Seasons and Climate.—Difficulties.—Effect of Grazing and Basic Cinder.—Grass v. Arable Land.—Flax.—Tobacco.—Raising Tobacco.—Its After Cultivation.—Its Cost.—Seed-testing.—Seed Impurities.—Numbers per lb.—Seed-testing Apparatus.—Spraying.—Bordeaux Mixture.—Burgundy Mixture.—Woburn Winter Wash.—Copper Sulphate.—Paraffin Emulsion.—Paraffin Metal Emulsion.—Soap and Carbolic Acid.—Arsenate of Lead.—Weeds, Pasture, and Arable.—Parasitic Weeds	150
--	-----

## PART II.

✓ *LIVE STOCK, FEEDING, AND ECONOMIC ZOOLOGY.*

## CHAPTER I.

## LIVE STOCK.

	PAGE.
Importance of Live Stock.—Pedigree Breeding.—Horses — Mares during Pregnancy. — Foals. — Colts. — “ Breaking.”—Management of Farm Team.—Food and Feeding.—Comparative Economy of Horse-power.— Breeds of Draught Horses.—Dentition of Horse . . .	189

## CHAPTER II.

## FARRIERY.

Anatomy of the Foot.—Manufacture of Shoes.—Shoeing. —Diseases of the Foot . . . . .	205
--	-----

## CHAPTER III.

## CATTLE.

Live Stock as an Aid to Agriculture.—Principal descriptions of Grass Land.—Cattle, Classes as well as Breeds.— Cattle Breeding: Study of Heredity and Mendelism.— Pure Lineage and “ Grading ”.—Ordinary Breeding.— Breeding and Dairying.—Management of a Herd.— Bull-breeding and Cow-breeding.—Why Milking Pro- perties have been Sacrificed.—Dry Cows.—Calving.— Feeding and Treatment of Calves.—Yearlings.—Two- year-olds.—Fattening Cattle.—Feeding.—Increase.— Merits of various Foods.—Cow-keeping for Small- holders . . . . .	214
--	-----

## CHAPTER IV.

## SHEEP.

Importance of Sheep.—Sheep-breeding.—Management of Ewes.—Drafting.—Lambing.—Ewe-keep and Lamb- keep.—Management of Lambs.—Importance of Change of Food.—Ram Lambs.—Quantities of Cake and	
--	--

CONTENTS.

xv

	PAGE.
Corn.—Tegs on Turnips.—Sheep for Small-holders.— Annual Events.—Wool.—Sheep-shearing Machines.— Dipping Appliances.—Sheep Dips and Dipping.— Dentition of the Sheep.—Goats.—Judging Live Stock	243

CHAPTER V.

Pigs.

Pigs for Small-holders.—Pigs on Large Farms.—Breeds of.—Pig-breeding.—Selecting Sows.—Management of Farrowing Sows.—And of Young Pigs.—Store Pigs. —Fecundity of Pigs.—Fattening Pigs.—Generality of Pig Fattening.—Fattening Pigs on Farms.—The Best Foods.—Hints on Management	269
---	-----

CHAPTER VI.

FOODS AND FEEDING.

The Carbo-hydrates.—Accumulation of Fat.—Waste in the Body.—The Proteins or Albuminoids.—Sources of Albuminoids.—Water in Foods.—Mineral Matter.— Grass as Food.—Mixed Character of Herbage.— Selective Instincts of Animals.—Mixing Foods for Cattle.—Roots as Food.—Straw as Food.—Chaff and Cavings.—Haulm.—Hay.—Green Fodder.—Potatoes. —Dietaries for Fattening Cattle.—Milking Cows.— Young Cattle	284
--	-----

CHAPTER VII.

ECONOMIC ZOOLOGY.

Parasites.—Flukes.—Tape-worms.—Cysts in Sheep (Gid). —Echinococcus of the Dog.—Thread-worms.—Armed Palisade Worm.—Giant Thread-worm.—Gape-worm.— Eelworms.—Stem Eelworms.—Ear Cockle.—Beet Eel- worm.—The Earthworm.—Myriapods.—Arachnids or Spiders.—Mites and Ticks.—Harvest Bugs.—Itch, Mange, and Scab Parasites.—Insects.—Classification of.—Saw-flies.—Ichneumon Flies.—Humble Bees.— Beetles.—Wire-worms.—Turnip Fly.—Weevils.— Butterflies.—White Cabbage Butterfly.—Surface	
---	--

	PAGE.
Grubs. — Hessian Fly. — Leather Jackets. — Carrot Fly. — Gout-fly. — Warble Fly. — Bot Fly. — Sheep Nostril Fly.—Thrips.—Green Fly.—American Blight. —Scab Insects.—Slugs and Snails . . . . .	301

## PART III.

### *BUILDINGS, MACHINERY, IMPLEMENTS, AND ACCOUNTS.*

#### CHAPTER I.

##### FARM BUILDINGS.

Complicated and Simple. — Adaptation of existing Buildings. — Extemporized Buildings. — Unnecessary Adjuncts. — Ordinary Dimensions of. — Simple Materials. — Mud-walls. — Weather-boarding. — Thatch, etc. . . . .	331
---	-----

#### CHAPTER II.

##### ENGINES AND FIELD IMPLEMENTS AND MACHINES.

Steam as applied to Agriculture.—Traction-engines.— Stationary Engines.—Practical Engineering Knowledge.—Transmitting Power.—Materials used for Agricultural Implements.—Disassembling and Lubricating.—Sources of Power.—Horse, Steam, Electricity, Wind, and Water. — Petrol and Oil. — Tillage Implements. — Ploughs. — Parts of. — Assembling and Placing the Parts. — Double and Multiple Ploughs. — Cultivators and Rollers. — Clod-crushers. — Harrows. — Drills. — Potato - planters. —Horse-hoes.—Self-binders.—Reapers and Mowers.—Swath Turners.—Teddors and Kickers.—Side-delivery Rakes. — Hay Waders. — Sweepers, Stackers, and Elevators. — Pyke - lifters. — Horse-rakes. — Spraying Machines.—Manure Distributors.—Dung Spreaders.— Hay Pressers. — Root Thinners. — Farm and Garden Implements . . . . .	343
--	-----

CONTENTS.

xvii

CHAPTER III.

PAGE.

CARTS AND BARN IMPLEMENTS AND MACHINES.

General Purpose Carts.—Floats.—Wagons, Drays, and Lorries.—Thrashing Machines.—Seed Dressers.—Winnowers.—Potato Raisers.—Potato Sorters.—Steam Ploughing and Cultivating.—Motors in Agriculture.—Food-preparing Machinery.—Grist Mills.—Cake-breakers.—Root Cleaners and Pulpers.—Chaff-cutters.—Chaff-steamer and Molasses Mixer . . . . . 380

CHAPTER IV.

LABOUR AND FARM BOOK-KEEPING.

Manual Labour.—Wages.—Number of Labourers required.—Effect of Live Stock on Labour.—Horse-labour.—Effect of Improved Implements.—Absorption of Horse Labour in Harvest.—Cost of Horse Labour.—Piecework.—Applied to Tillages and Carting.—Earning of Labourers, Summer and Winter.—Stockmen.—Total Cost of Labour per acre.—Hedging and Ditching.—Thatching.—Farm Book-keeping . . . . . 293

PART IV.

DAIRYING.

CHAPTER I.

MILK AND BUTTER.

Dairy Farming.—Selecting a Farm.—Water Supply.—Selection of Stock.—Points of a Cow (Ayrshire).—Milk Yield and Records.—Cow-houses.—Milk.—Constituent Parts of Milk.—Influences affecting Quality and Yield.—Milking.—Methods of Treatment of Milk.—Effects of Heat on.—Estimation of Fat in.—Water.—Total Solids not Fat.—Lactometers.—Cream-raising in Shallow and Deep Pans.—Cream Separators.—Butter-making.—Utensils and Water Supply.—Treatment of

	PAGE.
Cream and Utensils.—Churning.—Salting.—Working and Making up . . . . .	419

## CHAPTER II.

## HARD CHEESE-MAKING.

Milk Supply.—Herbage.—The Cheese-making Dairy.—Appliances.—Treatment of Milk.—Ripening Milk.—Acidimeter and its uses.—Rennet Tests.—Wisconsin Test.—Starters.—Heating.—Rennet.—Annatto.—Salt.—Treatment of Curd.—Hard Cheese-making.—Cheddar. — Cheshire. — Derbyshire. — Leicester. — Lancashire. — Gloucester. — Caerphilly. — Blue-veined Cheese.—Stilton.—Wensleydale.—Dorset Blue . . . . .	458
--	-----

## CHAPTER III.

## SOFT CHEESE-MAKING.

Principles.—Drainage.—Equipment.—The Making-room.—Ripening.—Cream Cheeses.—Double Cream Cheeses.—Cambridge or York.—Slipcote.—Camembert.—Coulommier.—Pont l'Évêque.—Gervais.—Proprietary Cheeses . . . . .	480
--	-----

## PART V.

## ✓ HORTICULTURE.

## CHAPTER I.

## PLANT LIFE.

Heredity and Variation . . . . .	491
----------------------------------	-----

## CHAPTER II.

## HARDY FRUITS, FLOWERS, AND SOIL PREPARATION.

Soils and Situations. — Propagation. — Bush Fruits. — Strawberry Growing. — Raspberries. — Blackberries and Allied Fruits.—Manuring Fruit-trees.—	
---	--



## CONTENTS.

Planting of Fruit-trees.—Pruning.—Root-pruning. —  
Training. — Fruit Plantations. — Grass Orchards. —  
Selection of Trees.—Varieties of Fruits.—Gathering  
and Marketing.—Apples and Soft Fruits.—Storing  
Fruit.—Flower Culture.—Potting.—Artificial Soils.—  
Trenching.—Bastard Trenching . . . . .

### CHAPTER III.

#### MISCELLANEOUS OPERATIONS.

Watering.—Vegetables.—Salads.—Seed-beds.—Sowing and  
Planting.—Manuring Vegetables.—Marketing Fruits,  
Flowers, and Vegetables.—Packages and Materials .

### CHAPTER IV.

#### PLANT DISEASES.

Spraying. — Roots. — Finger and Toe. — Black Rot. —  
Mildew. — Heart Rot. — Cereals. — Wheat Rust.  
— Gooseberry Mildew. — Bunt. — Smut. — Potato  
Blight.—Scab.—Clover Sickness.—Ergot . . . . .

## PART VI.

### *POULTRY, RABBITS, AND BEES.*

#### CHAPTER I.

##### DOMESTIC FOWLS.

General Remarks.—Equipment of a Poultry Farm.—  
Breeds. — Selecting Stock Birds. — Layers. — Table  
Fowls.—Points of Exhibition Fowls.—Natural and  
Artificial Incubation. — Soil Conditions. — General  
Principles of Feeding Poultry.—Chicken-rearing.—  
Brooders.—Wet Feeding.—Dry Feeding.—Preparing  
Poultry for Table.—Killing.—Plucking.—Trussing for  
Roasting and Boiling.—Commercial Poultry Farming

## CONTENTS.

## CHAPTER II.

## TURKEYS, DUCKS, GEESE, GUINEA-FOWLS, AND RABBITS.

	PAGE.
Turkeys.—Soil and Situation best for.—Breeds and Stock Birds.—Feeding.—Ducks.—Breeding Pens.—Breeds of Ducks (Aylesbury, Pekin, etc.).—Rabbits.—Breeds and Feeding . . . . .	603

## CHAPTER III.

## BEES AND BEE MANAGEMENT.

Queens.—Drones.—Workers.—Subduing and Handling.— Swarming and Driving.—Uniting.—Queen Rearing.— Feeding and Wintering.—Diseases . . . . .	612
---	-----

# PART I.

*SOILS, MANURES, AND CROPS.*

# PART I.

## SOILS, MANURES, AND CROPS.

---

### CHAPTER I.

#### ORIGIN, COMPOSITION, AND DISTRIBUTION OF SOILS.

**Origin.**—The student who attempts to trace the origin of soils to their source will find that he has undertaken an impossible task, involving questions of the evolution of the earth from a gaseous and molten state, sustained for long ages at a temperature of high fusion. He must necessarily narrow his horizon, and accept the present condition of the planet as a starting-point, and, even then, the ages occupied in the formation of soils probably extended over millions of years. In order to realize this view a knowledge of geology is necessary, and some idea of astronomy, especially in relation to the solar or planetary system. With such matters agriculture has little to do, and the study of soils must be confined within practical limits from which speculative views are excluded. Still, even regarding soils as already existent, they are of incalculable antiquity, as is amply proved by their composition.

We know little of the interior of the earth, although it is certain that it retains much cosmic heat, but whether its core is in a liquid, plastic, or solid state is unknown. The "crust", so far as it can be studied, is composed of igneous, metamorphic, and sedimentary rocks, covered for the most part by water, but in nearly all cases with a loose sandy, calcareous, argillaceous, or mixed material which may be called soil.

The materials which now constitute the sedimentary (and probably all) rocks bear evidences of having been repeatedly reduced, and again hardened into compact strata. The immediate cause of existing soils may be summed up as, *degradation* of previously existing rocks through the action of running water, gradual solution effected by moisture and carbonic acid gas, glacial action, changes of temperature, wind, vegetation, and, finally, cultivation. These forces, acting through ages of incalculable length, and still acting, are responsible for all soils.

**Formation of Soils.**—The above disintegrating and wearing forces were (and are) supplemented by transporting and mixing agencies in which they also took part. Thus, running water not only carves channels and canyons through masses of compact rock, but carries with it mineral fragments of all sizes, and is rendered turbid by finer particles which are deposited as mud at lower levels. A sorting of materials is effected, the heavier matter being left behind in the onward rush, while the finer parts are carried forward until they subside in sluggish streams, or are laid down as lacustrine deposits. Thus it will be found that where a river debouches upon a plain the upper portions of the valley are composed of loose sandy or gravelly soils, while further down they are of finer and more tenacious texture.

The rough and tumble passage of the Great Northern drift, whether effected by water, ice, or both, is answerable for vast areas of soils of mixed character, interspersed with boulders of various sizes, water-worn pebbles, sand, and clay. Deposits of china clay may occur in one place, and of pure sand or gravel in another, but in all these cases we see the effects of moisture, first

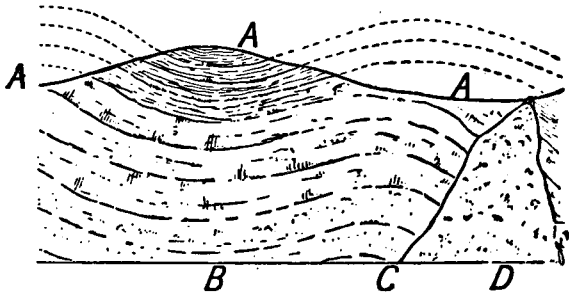

FIG. 1.—Section of curved strata, showing where the upper parts (indicated by dotted lines) have been swept away to form a basin or hollow. *A, A, A*, present land surface; *B*, synclinal part of strata (basin or hollow); *C*, anticlinal curve (ridge); *D*, an irruption of igneous rock.

as a decaying, and then as a transporting agency. In others the soil appears as a mere cast-off film of the underlying rock. Here is no evidence of transportation, but rather of long and silent decay, produced by exposure to the elements, assisted by the root action of plants. Chalk downs, fells, and heaths abound in soils of this description, in which the colour, texture, and mineral fragments all indicate the close relationship of the soil with the rock beneath it.

It is, however, noticeable in many cases that such soils are not derived entirely from the underlying strata, but contain materials which formed parts of strata that at one time covered the present surface (Fig. 1). Such is the explanation of the hills capped with clay so often seen in districts of the Upper Chalk, which are in fact remnants of the London Clay, that at a remote period covered the Chalk.

Denudation has been a potent instrument in the formation of soils, and during the process it is only natural that fragments of the upper strata should have remained in and on the exposed surface. This mixing of materials from above and below accounts for many anomalies between the appearance of the loose soil and the composition of the underlying rock. The expressions "transported" and "in situ" convey the above two ideas, namely, that soils have either been deposited at a distance from their origin, in which case they are always of mixed and often of fertile character, or that they are composed of materials derived from strata immediately below and above them. This principal division of soils teaches the great importance of surface as distinct from block geology, for the latter is often inconsistent with the character of the soil. Before any close relationship between geology and agriculture can be established, surface maps must be constructed showing the presence of accidental accumulations of sand or clay and other materials which "mask" the main geological features of the particular district.

Hitherto we have viewed soils as derived from rocks or transported mineral matter, but before a just idea can be formed as to their actual composition, vegetation must be taken into account. The irrepressible and universal invasion of vegetation is a remarkable fact. No sooner is a surface, even of compact rock or masonry, exposed to the air than it becomes covered with a growth, first of lichen, then of mosses, and finally of grass and shrubs. It is owing to lichens and mosses that new buildings lose their bizarre appearance in a few years, and blend and harmonize with the surrounding landscape. It is this which gives their picturesque appearance to ruins and cottages, and to which rocks owe their rich and varied colour and softness of outline. Vegetation penetrates, and derives nourishment from the most unpromising materials, for even glass becomes coated with green, and newly tiled roofs lose their startling red or slate colour. As the earlier generations of plants are succeeded by others, a soil is gradually formed, partly composed of organic and partly of inorganic matter, until a higher class of vegetation becomes possible. Vegetation is aided by atmospheric processes, until finally the continuity of the rock gives way, and a thin soil is the result.

In order to understand these processes almost unlimited time must be allowed, as well as for the action of frost and thaw, which gradually eat into the hardest rocks, and cause them to crumble. What is called "weathering" erodes the surfaces of quarries and public buildings, tombs, and soil. Soil is a result of the decay of previously existing rocks (Fig. 2), but is also in many cases the material from which future rocks may be formed, and thus soils form a link in the endless chain which in long ages makes and remakes continents, changes the levels of oceans, and keeps the earth young and fruitful.

**Composition of Soil.**—The origin and formation of soils lead to the consideration of their composition. They must necessarily be largely composed of minerals, but cannot be regarded as merely ground-up or pounded rock. On the contrary, they are ripened and

prepared for plant life by infinitely prolonged processes of digestion. Their unctuous or greasy character is due to the presence of impalpable powder, and also of organic matter which gives a brown colour to all fertile soils and confers properties upon them affecting their powers of absorbing water and gases, and, as will later be seen, fitting them for the nurture of billions of micro-organisms which further decompose and prepare plant food.

The soil, apart from analysis, is a truly marvellous product. Its texture and solidity make it a suitable home for and protection to vegetation. Its porosity enables it to retain moisture and gases, as well as fertilizing matter. Its complex composition supplies food to the roots, and rain brings down water for dissolving it. Soil is also in a perpetual state of flux and renewal, so that ultimate exhaustion seems wellnigh impossible. It is at once a *magazine* of future plant food, a *storehouse* for the present, and a *vehicle* for transmitting its riches to growing plants. It is a *chemical laboratory* in which beneficent changes are always taking place, and a *physiological laboratory* in which lower forms of life are operating upon organic and inorganic matter for the future benefit of mankind.



FIG. 2.—Formation of Soil. 1, thin layer of mould; 2, layer of shattered rock, partly derived from underlying rock; 3, the underlying compact rock on clay bed; 4, pockets, often seen in chalk, showing where trees have stood and caused borings through long-continued root action; 5, gravel bed resting on flanks of a slope.

*The composition of soils* may be viewed physically or chemically, and of late years, biologically, if the myriads of protozoa (Fig. 3) and microbes it contains may be viewed as forming an integral part of it. So far as its general or proximate composition is concerned, it mostly consists of sand, clay, calcareous matter, and humus, to which may be added mineral fragments of all sizes, and vegetable matter, not yet decomposed. None of these bulky materials are in themselves fertile, and even when mixed together they scarcely represent a true soil. Fertility depends upon the association of plant food with these cruder constituents, in the form of soluble salts of phosphoric, sulphuric, nitric, carbonic, and other acids, which occur in all native clays, sandstones, and limestones; and in the vegetable matter found in all soil.

"Clay" is an extremely indefinite term, used to describe the more unctuous portions of the soil, and is not of definite composition or represented by any formula. It is composed of very minute particles, and is therefore extremely porous, and capable of retaining

fertilizing matter, of condensing gases, and holding moisture. It is, in a word, "retentive," and is generally regarded as a sign of fertility. There are poor clays and rich clays, the former being pale yellow or whitish, whereas rich clays are red or hazel brown, owing to the presence of iron peroxide and organic matter. *Sand* also seldom exists in soils in the purely quartzose form, but as calcareous, micaceous, and siliceous sands, of a loose texture, which mitigate the tenacity of the clay. *Calcareous* matter may be derived from shells, chalk, limestones, or marl which is merely calcareous clay. *Lime* is in itself a plant food, which cannot be said of either clay or sand, and is an essential ingredient of all fertile soils. *Stones* occur in all soils, and are survivals of pre-existing rocks—sometimes angular, and sometimes rounded and water-worn. They also occur as flints, gravel, or as "land-fast" boulders. Sand is of different sizes, from fine silt, which will pass through the sieves used in preparing soils for analysis, to larger fragments which are rejected

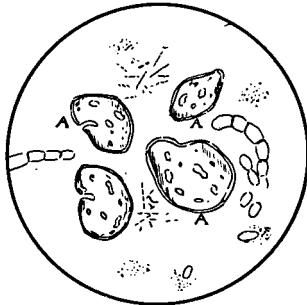

FIG. 3.—Drop of Hay Infusion under the microscope showing Protozoa (A A A).

by the analyst as scarcely belonging to the soil as a productive agent.

The intractable parts of a soil are no doubt in process of reduction through the agency of the same forces which caused the decay of the original rocks, but the transition is extremely slow. It is most rapid in the case of the more minute (microscopic) matter, and less so in that of the larger fragments, but in process of time even the stones which occur in land will weather and yield up plant food. They may therefore be regarded as a magazine for future use, and a safeguard against ultimate exhaustion. Tillage operations accelerate this gradual breaking-up of stony fragments, and in some cases an exfoliation may be noticed after severe frosts. Few stones are entirely inaccessible to moisture, and what is seen to take place on the faces of quarries, on masonry, and crumbling ruins must occur in the soil, and increase the amount of impalpable matter within it.



Remains of roots, stubble, grass, leaves, twigs, branches of trees, etc., are always to be found both on and below the surface of soils. They are at first fibrous and of no fertilizing value; but as they decay, and turn into vegetable matter, or "humus", they confer important properties upon soils. Humus improves the texture of soils and increases their absorptive properties. It regulates their temperature, and mitigates their tenacity. It binds together light sandy soils, and gives a rich colour to garden mould. It is always a sign of fertility, and was for long regarded as its principal cause. It is a source of nitrogen, and is acted upon by processes of oxidation (slow combustion), and by putrefaction, fermentation, and the action of micro-organisms which finally produce nitric acid and nitrates. It is also a source of carbonic acid gas, which, when dissolved in water, facilitates the solution of mineral matter in the soil. The most recent additions of vegetable matter are of the greatest importance. They are in a state of rapid decomposition, but as decay progresses it becomes slower. The residue becomes more carbonaceous and correspondingly moist. The effect of new vegetable matter is always beneficial, as it is a means of introducing material in a state of active decay, from which are evolved the mineral salts which all vegetable tissues contain, as well as ammonia, nitrates, and much carbon dioxide.

A fertile soil is therefore seen to be an extremely complex and inimitable material. It is, indeed, a cause of regret to up-to-date agricultural chemists that the synthesis or artificial production of soils has made so little progress. Until soils can be produced synthetically, we are told that we cannot have full control over the changes and variations which occur in nature, and must accept the condition: as they exist in natural soils. Soils, it is true, may be blended and mixed, but this is scarcely synthesis, as such mixtures are mere "composts", produced by adding together various proportions of sand, clay, lime, and vegetable matter, all of which are impure from a chemist's point of view.

To sum up: soil is a product of decay—decay of rocks, of animal and vegetable matter; of decomposition, and of death. It is a cemetery of defunct matter, but at the same time, the source of all life; for without soil neither vegetable nor animal life could exist. It is the indirect source of mind as well as of body, for starvation equally paralyses both, and without the soil starvation would be inevitable, and reproduction impossible.

**Ultimate Composition of Soils.**—Hitherto the soil has been regarded as a whole, and it now remains to consider its analytical composition. The subject is full of difficulties; first on account of innumerable variations, not only over small areas, but in the vertical section. These variations are mechanical as well as chemical, and may also be due to cultivation and cropping.

In the early days of agricultural chemistry much reliance was placed upon soil analysis, until it was discovered that mere tabulated statements of composition were not a true index to fertility. The difference between soluble and insoluble, available and unavailable plant food was fully recognized, but not the powerful effect of roots

in attacking materials insoluble in rain-water. The porosity of clay, and its property of fixing plant food was discovered by Way in 1852, and he demonstrated the power of soils to absorb fertilizing matter. This appeared to be due to the "clay" in a special degree, but in his famous researches he prepared a number of double silicates of lime and ammonia which acted in a similar manner and, like clay, lost this power when ignited. This was the foundation of the "double silicate" theory, but Way failed in establishing the existence in soils of such double silicates, although their action so closely resembled that of the reacting constituents in the soil "that he considered himself justified in assuming their presence". The action appears to be chemical so far as mixed salts are concerned, for Dr. A. Vöelcker showed that when ammonium sulphate is added to the soil an insoluble nitrogen compound is formed which remains in the soil, while the calcium sulphate appears in the drainage water. This is chemical action, but does not apply to the power of soils to remove organic matter; for in this case nothing is given up by the soil in exchange for the organic matter withheld from, say, sewage.

"Clay" is too comprehensive a word, as all native clays are composed of various mineral substances, often associated with organic matter, and have no definite composition, nor can they be identified by any formula. That they contain silicates of alumina in varying proportions, resembling kaolin or china clay, is certain, but they are not definite chemical compounds. Clay behaves precisely like a "solid solution", and is regarded by Bemmelin as an "absorptive compound in which the constituents are not chemically united, but are held by the feebler forces manifested by *colloids* in their attractions one for the other". Thus true clay (aluminium silicate) is regarded as a plastic colloid, and is described by Dr. E. J. Russell as "an electro-negative colloid" which only exhibits the properties under consideration when moist. It is highly plastic, and can be readily moulded into shapes. It becomes rigid and brittle when heated, as is seen in pottery, and loses its colloid properties. This colloid substance is answerable for the tenacity of clay soils as well as for their absorbent properties, but only forms a fraction of the material which is commonly called clay. The bulk of a native clay is composed of gritty or sandy particles, of mineral fragments, nodules of lime, organic remains, salts of iron, of potash, phosphoric acid, and all the other ingredients of a fertile soil, associated with a fractional part of the colloid substance which especially confers upon it the plastic character. Clay is of great importance, and in a great measure controls the nature of the soil. Without it the soil may degenerate into a blowing sand, and when it occurs in excess it may be too tenacious for tillage.

*Sand* mitigates the plastic character of clays, facilitates drainage, and promotes warmth.

*Lime* may act similarly to sand, many sands being of calcareous character. It is a true plant food, as is also magnesia, which is another alkaline earth. Carbonate of lime is often spoken of as the base which acts upon the organic and inorganic materials of the soil; combining with nitric acid as it is liberated, to form nitrate of lime.

*Vegetable matter* occurs in all fertile soils, and is at once a product and a cause of fertility. It has to a great extent been derived from the atmosphere, but inasmuch as it yields an ash it has also been derived from the soil. It is largely carbonaceous, but is also nitrogenous, especially when recently formed.<sup>1</sup> There is a considerable difference between fresh vegetable matter, such as yard manure, stubble, roots, leaves, etc., and the inert brown matter known as *humus*. The former are in a state of decomposition, evolving carbonic acid and ammonia, and even a certain degree of heat, the latter has passed through its initial putrefactions and fermentations, and has lost much of its hydrogen and nitrogen, although it still retains a good deal, as well as other useful properties. It is retentive of moisture, but parts with heat rapidly. It assists in keeping clay soils open, and, as shown by Koenig, possesses a marked power of absorbing ammonia from ammonium sulphate. Humus is stable or permanent compared with recent additions of organic matter, and occurs largely in peat.

Mineral fragments such as gravel, flints, etc., exercise a powerful influence upon soils. They, like sand, open up clay soils, and to some extent may be regarded as a magazine of future plant food. Thus fragments of sandstone, limestone, or of chalk or clay slate no doubt slowly disintegrate and ultimately become reduced into small particles which would pass through the fine meshes used in soil analysis. The main effect of pebbles and stones is, however, that of preventing clay soils from becoming too close in texture, and this property is well shown in districts where the presence of innumerable flint stones so alters the character of the clay as to render it suitable for winter folding, and for producing crops more usually grown on light land. Stones are the remains of stratified and unstratified rocks, which have been intermixed with the looser material of the soil. Flints occur in the Upper Chalk formation, sometimes in horizontal and sometimes in perpendicular lines, and do not *grow* as is still thought by many farmers. Their continued appearance on the surface after repeated picking is due to their being ploughed up; and as the surface is lowered by the removal of hundreds of cartloads per acre, the plough sole will also be lowered, and fresh relays of flints brought to the top. Nothing can show more ignorance of the nature of flints than to assert, as many do, that they grow.

The varied character of clay, the peculiar functions of lime and sand, and the fluctuating nature of organic matter all indicate a highly complex material. The general result is that the upper 9 inches of soil comprise the most important part of agricultural land. Below this depth the amount of nitrogenous matter diminishes, and the cultivatable section begins to change into subsoil. The absorptive power of the surface is so great that it in a great measure prevents the downward passage of fertilizing matter. It does not completely retain nitrogen, and little perceptible difference in nitrogen content was found at Rothamsted between subsoils at 18 and 27 inches deep,

<sup>1</sup> The percentage of nitrogen in humus may be comparatively higher than in new vegetable matter on account of the great loss of carbon, but this does not affect the fact that the original amount of nitrogen in fresh vegetable matter is also reduced.

whether unmanured for fifty years, or receiving 200 lb. of nitrogen in farm-yard manure, annually, for the same lengthened period. The accumulation of nitrogen in the surface 9 inches was, however,  $2\frac{1}{2}$  times as great in the case of the manured as contrasted with the unmanured land, which shows that the nitrogen chiefly circulated within a 9 in. section of the upper soil. The roots of growing plants take up and fix the soil nitrogen, and thus assist the superficial dressings of dung; while any nitrates washed through the soil find their way into the drainage water, or become denitrified for want of air. So far as nitrogen is concerned, the first 9 inches of soil therefore strongly tend to retain it.

The *subsoil* must not, however, be dismissed as unimportant, even as regards the fertility of the upper soil. The roots of plants penetrate it, and pump up nitrates and mineral matter from its recesses. These are elaborated in the tissues of growing crops, and find their way back to the surface soil, either directly or indirectly. The subsoil is therefore a source of plant food, but it exercises still more important effects, as it is through the subsoil that drainage can be effected, and capillary moisture and warmth can rise to the surface.

In most cases there is no fixed line of demarcation between soil and subsoil, and they may even be of equal richness, in which case the cultivated section may be deepened with advantage. Sandy or gravelly subsoils act as drains, while clay subsoils are a safeguard against drought and excessive heat. In the first case soils will burn in hot summers, and in the other they will remain fresh and verdant. Other cases might be cited, but the above remarks clearly show that a good subsoil is of enormous importance.

The *ultimate* composition of soils can only be ascertained through a complete chemical analysis, as well as by an examination of physical properties. The one is as important as the other, but when both have been made, no opinion can be formed as to productiveness until several other points have been cleared up. A soil may, for example, be excellent *qualitatively*, but deficient *quantitatively*. It may be thin, and the substratum may be defective. The rainfall and the climate may be unsatisfactory, and before these matters are taken into account no estimate can be given as to its fertility. Neither is the value of a soil to be measured entirely by its fertility, for *position* overrides even that important consideration, and a poor soil, well placed for markets, may easily be of greater value than a rich soil remote from means of transit. A full report is therefore necessary, and this involves much expense, and requires an extensive knowledge both of chemistry and agriculture.

As to the matter immediately before us—the ultimate composition of a soil—plant food naturally occupies an important place. At present it is enough to state that plant food consists of certain salts,<sup>1</sup> the most important of which are of potassium, sodium, calcium, magnesium, iron, phosphorus, sulphur, chlorine, silicon, nitrogen, and carbon. Oxygen occurs in all of these, as it is the chief agency by which chemical elements are converted into bases and acids. All

<sup>1</sup> Salts are combinations of a base with an acid, such as ammonium sulphate, calcium carbonate, or sodium nitrate.

plant foods are presented in the form of soluble salts, and it is therefore important that the amount of each substance soluble in a dilute acid of standard strength should be ascertained. A mere watery extract is not sufficient; for vegetation possesses dissolving powers, equivalent to that of certain weak solutions of various acids, among which a 1 per cent solution of citric acid in water has been adopted in Great Britain. Standardized hydrochloric, acetic, and carbonic acids are used in other countries, with varying comparative results. So far as the small amounts dissolved out of the mass of the soil are concerned, there is a similarity in the effects of all these acid solutions; but within those limits there are considerable differences, sometimes amounting to multiples of 3, 4, or 5. The extractive powers of plants, however, differ from each other, so that the main point is to know which agent is employed, and a 1 per cent solution of citric acid as proposed by Dr. Bernard Dyer is found to be satisfactory for supplying an index as to the amount of available plant food.

The extremely small proportion of soluble and available plant food compared with the total weight of soil is in itself an interesting fact. An acre of arable loam, 9 inches in depth, will weigh when perfectly dry about 3,000,000 lb. A pasture soil will be lighter, and when the roots are removed, and the moisture is driven off by heat, will weigh about 2,500,000 lb. "Supposing, therefore, a dry soil to contain 0.10 per cent of nitrogen, phosphoric acid, or potash, the quantity in 9 inches of soil will be from 2,250 to 3,000 lb. per acre" (Warington). This is total contents, but the amount of immediately available food is much less, and has been found to amount to from 0.011 per cent of potash to 0.0684; and from 0.0011 to 0.0477 per cent of phosphoric acid, according to the condition of the land, previous manuring and the reagent employed. It is impossible to give average figures, but if the continuously unmanured plot examined at Rothamsted is taken, where the citric acid test was employed, the amount of available potash in the soil amounted to 0.0043 and the amount of available phosphoric acid to 0.008 per cent of the total weight. Strong hydrochloric acid, when used on the same soils, dissolved out respectively 0.38 per cent of potash and 0.114 per cent of phosphoric acid, but much was left behind, and was only rendered soluble by deflagration with hydrofluoric acid. Thus Warington's hypothetical figure of 0.1 per cent of any constituent is much too low as an index of the total contents of potash or phosphoric acid, even in the exhausted unmanured wheat field at Rothamsted; for, as he says, "an acre of land may contain many thousands of pounds of phosphoric acid and yet be in poor condition."

The available or soluble amount is the true index of fertility, and it will at once be seen that this may be expressed in the second and third place of decimals. We need not here go farther, for it is evident that by placing the decimal point in accordance with these results, 3,000,000 lb. of soil might contain from 300 to 3,000 lb. of any soluble plant food existing in the proportion of 0.001 or 0.01 per cent of the entire weight, and might be multiplied to standards of 0.002 or 0.02 per cent according to analysis. Now as an ordinary

crop of wheat of 30 bushels per acre removes 14 lb. of phosphoric acid, we have a measure of the rate of exhaustion of available plant food. A crop of 44 tons per acre of mangel-wurzel removes in the roots 73 lb. of phosphoric acid, and would therefore much sooner exhaust a soil of its available supply than wheat. Fourteen tons of swedes remove in roots 17 lb. of phosphoric acid and 70 lb. of nitrogen; and other cases might be given.

The question of soil exhaustion is not, however, settled by such calculations, as there is a gradual passing over of mineral matter from a condition insoluble in even strong acids, to an available state which however slow must tend to keep up fertility. The restoration of nitrogen sometimes takes place rapidly, especially on grass land, even when mown annually. Thus in a case at Rothamsted supplied by Dr. E. J. Russell the percentage of nitrogen increased from .205 in 1879 to .338 in 1912. This increase is attributed partly to the leguminous herbage, but also to the accumulation of organic matter generally, for all organic remains contain nitrogen. Ultimate exhaustion is also prevented by the application of fertilizers, and the use of purchased food, all of which are rich in ash constituents, as well as in carbonaceous and nitrogenous matter. Cultivation also assists in promoting the reduction of mineral fragments to smaller size, by trituration and exposure to atmospheric forces; and one of the functions of organic matter is to evolve carbon dioxide and form a solution with rain-water, which dissolves mineral matter from intractable substances. The very presence of soluble materials in soils shows that they have been produced; and the beneficial effects of bare-fallowing prove that the process need not require centuries or even decades, but may be made to occur during a single season.

**Soil Analysis.**—Every textbook gives analyses of soils, and it seems unnecessary to take up space by tabular statements, which, after all, have but little to do with fertility. There can be no doubt that a soil may be rich according to analysis, and unproductive in practice, and the reverse is equally true. Analyses are more likely to show why a soil is barren than why it is productive, and may also account for extraordinary richness. It may reveal the presence of proto-salts of iron, of acidity, of an excess of soda, or of injurious materials. Fertility depends upon such a large number of circumstances, above, below, around, and in the soil, that a mere chemical analysis is insufficient. It is, in fact, only one out of a hundred conditions of fertility, and in order to be of much use should be carried beyond a mere statement of contents. We therefore refer our readers to books and encyclopædias, readily accessible, and pass on to the consideration of the constitution of the soil.

**The Constitution of the Soil.**—But little is at present known of the constitution of the soil. It is the very earth we tread on; and yet the cause of its fertility and its relations towards growing plants are very imperfectly understood. It is of indefinite depth, and therefore of volume, and its construction is affected by the prevalence of clay, sand, lime, mineral fragments, and organic matter, each of which may stamp it with a special character. The clayey character may become obscured under the influence of organic matter, or

by the co-mingling of coarser mineral matter with the colloidal substance which is the actual clay. The sand graduates into fine silt, which may be described as mud, and the lime may exist in many forms besides that of carbonate.

The organic matter is even more complicated, for it is found in the rocks from which the bulk of the soil was derived, and in this respect may be said to be as old as the soils themselves. It also exists as "humus" or brown peaty or turf-like matter, often of acid reaction, in a more or less decaying condition, but on the whole fairly stable in its condition. Organic matter is constantly being recruited from growing vegetation, and is therefore present in all soils, as root fibres, leaves, and straw, all of which are passing into mould. These remains of previous life are the theatre of bacterial action, and it is from them that nitric acid is evolved for practically unlimited periods of time. Farm-yard manure is only another form of organic matter, and as long as it or its equivalents are supplied in sufficient quantity, and crop residues continue to be left, the supply can never fail.

Organic matter, however, accumulates most rapidly in unbroken-up land, and disappears under cultivation. On this point much stress is laid by Dr. Russell in his recent work on soil conditions and plant growth. At p. 81 he writes: "There is no reason to suppose that the amount of nitrogen in a prairie soil alters perceptibly from year to year so long as the land is untouched. But directly ploughing and cultivating operations begin, great losses of nitrogen set in. . . . *The exhaustion of the soil is therefore not due to the removal of the crop, but to cultivation.*" This loss of nitrogen is simultaneous with a diminution of organic matter, for arable land is always poorer in organic matter than pastures, and the loss of nitrogen seems to be due to the escape of free nitrogen. The conditions necessary for this evolution of nitrogen gas appear to be the free admission of air and the presence of large quantities of easily decomposable organic matter. According to this view the loss of nitrogen is not by any means all due to the removal of crops, but largely to the exhalation of free nitrogen under the influence of cultivation, and applications of farm-yard manure. Neither does it appear to be the same as denitrification, but rather an exhalation of free nitrogen which has not reached the nitrate stage. The action takes place under tillage, and in contact with freshly added masses of organic matter, whereas denitrification seems to occur in waterlogged soils from which air is excluded. The nitrogenous matter in soils may therefore lose its vital constituent through cultivation and manuring, and also by the denitrification of nitrates in waterlogged soils.

The Colloids in Clay.—The constitution of a soil is controlled by the presence of "compound particles" produced by the soil colloids and the calcium carbonate; and of these compound particles little is known. If the mineral particles such as clay, fine silt, sand, etc., are regarded as ultimate particles, they are largely bound together as compound particles, and how far these are modified by this union we cannot say. "How the colloids are arranged in the soil is not known, but the simplest view, and one in accordance with all the facts, is that

the mineral particles, especially the fine silicate particles, are coated with a colloidal complex, containing silica, alumina, ferric oxide, alkaline bases, and phosphoric acid derived from the weathering of the rock material, and the so-called humus. These various compounds are not in true chemical combination, but in a state of absorption or solid solution" (Russell). They appear to be decomposable by changes in temperature, and to interact with various solutions such as dye stuffs, sewage, and manures; either by absorbing them as a whole, or simply giving up to the solution an amount of base, equivalent to what has been absorbed. This is at least one of the most modern views, although it is not the only one. It is in advance of the older theory of double-silicates, which is too cut and dry to fit in with the results of modern research. The existence of these compound particles also "puts out of question any complete quantitative interpretation of a mechanical analysis".

The constitution of the soil is therefore an extremely complicated problem very difficult to solve, and when we take into account the endless variety and condition of soils it is almost hopeless. The subject is by no means easy to follow, but an attempt has been made in the above remarks to present to readers the main points of the question.

**Life within the Soil.**—When we consider the extreme antiquity, the complex character, the perpetual renovation, the constant evolution of gaseous matter, and the additions of vegetable matter from growing plants which are all illustrated in every fertile soil, no one can fail to be struck with wonder and admiration. The soil is a graveyard in the widest sense, and yet it is the very mainspring of new life. If any object can demonstrate the possibility of resurrection, it is the soil upon which we walk. Equally wonderful is it that it is not an inert mass, but the scene of endless preparations and changes, not only brought about by chemical action but by living organisms. We are familiar with the fact that certain animals live in the soil, of which the mole is perhaps the best example. The mole is a tiller of the ground, but in this respect he is excelled by the earthworm, which is responsible for the presence of vegetable mould in pastures.

It was, however, reserved for the present generation to discover the teeming populations of minute organisms in the soil, beyond the range of the most powerful lenses. The vista extends to limits which defy even imagination, until biologists speculate as to whether mere slime is not composed of living atoms, too minute to be brought within the field of microscopic observation. Be this as it may, every fertile soil is inhabited by organisms, which far exceed the human or animal populations of the entire globe. Thousands of millions are as nothing, for a single ounce of soil is estimated to contain from 100 to 300 millions of bacteria alone, and in order to arrive at their number in an acre of land, these enormous numbers would require first to be multiplied by 16, and then by the number of pounds per acre of soil 9 inches in depth, which we have seen is from  $2\frac{1}{2}$  to 3 million pounds. But bacteria are only one order of the army of micro-organisms. There are protozoa, of which over two dozen sorts



have already been under investigation. Many of these protozoa, although minute to us, are a thousand times the size of the bacteria upon which they prey. There are possibly larger, but still minute, organisms; and the inquiry reveals a state of war within the soil; and rivalries which disturb the balance of power in that domain, as much as do rival nations in the world above. There are useful bacteria, engaged in the work of nitrification, and protozoa which prey upon them, or invest particles of organic matter and keep them off. There may be even more formidable protozoic enemies, of such comparative size as a mouse with a cat, or a cat with a tiger. So minute are these forms of life that many of them cannot be examined microscopically, but just as physicists find methods for measuring the dimensions and speeds of atoms or corpuscles of matter, so biologists are able to estimate life in the soil. When an antiseptic

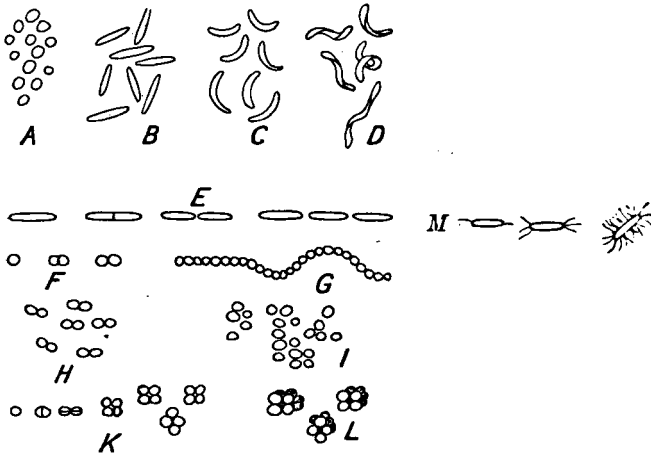

FIG. 4.—Forms of Bacteria. A, Cocci; B, Bacilli; C, Vibriones; D, Spirilli; E, reproduction of bacillus; F, reproduction of coccus (giving rise to—G, Streptococcus or chain; H, Diplococci or pairs; I, Staphylococci or irregular group; K, Micrococci, by dividing in two directions; L, Sarcinae, by dividing in three directions); M, arrangement of flagella or tails.

sterilizes a soil, and thereby arrests certain processes and changes, such as the change of organic matter into ammonia, or ammonia into nitrates, it is now assumed that these changes are due to micro-organisms. Antiseptics are used as the test, but they are also used for the destruction of injurious organisms and the encouragement of beneficial ones.

Bacteria (Fig. 4), moulds (Fig. 5), fungi, and algæ are all vegetable, and are spoken of as "flora", while protozoa are low forms of animal life and are described as "fauna". "It would be a mistake, however, to suppose that they are all there for the purpose of making food for our benefit. On the contrary, they are living their own lives, just as are the animals in an uninhabited country.

Some of them, it is true, are useful to us, others are not. Some actually destroy the plant food that has already been made, while others are injurious to the useful food-making organisms. Indeed, the top 6 inches of soil might almost be called a separate world, so vast is the number and variety of its inhabitants, and if a man could introduce himself into it and see what was going on, he would have such a tale to tell as would put to shame our most imaginative writers of romance."

This remarkable passage brings prominently before us a phase in the constitution of soils of which the early agricultural chemists never dreamt. Taken in connexion with the complex structure and functions

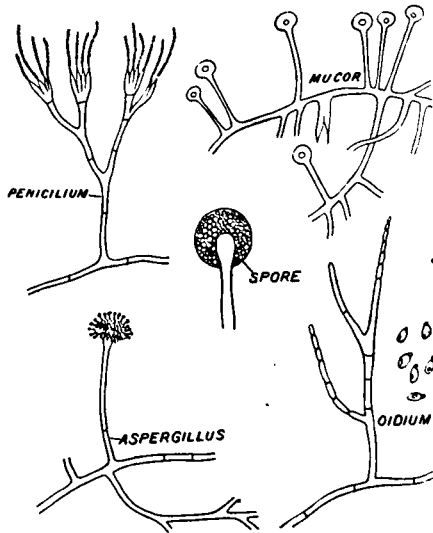

FIG. 5.—Forms of Moulds.

of the soil, previously explained, it opens up a new realm of investigation. These microscopic creatures require air (oxygen), water, warmth, and food, and when deprived of these necessities they either cease to exist or become paralysed. They, however, exist as spores (Fig. 6) as well as in a mature state, and although the latter may be killed in myriads no process has succeeded in killing the former. There are certain substances and conditions which destroy micro-organisms, among which may be mentioned carbon disulphide, toluole, chloroform, and certain volatile antiseptics, or a temperature of over 212° F. It was, however, observed by Hillner and Störmer that the effect of carbon disulphide was, first to decrease, and then to increase the number of bacteria in soils, and that in a remarkable degree. The first decrease in fertility was no doubt

due to sterilization, which means the death of useful bacteria. The destruction was not, however, complete, for many spores were uninjured. In the sterilized soil all the protozoa, with the exception of one small species, were killed, cysts and all. As already explained, the protozoa belong to the animal kingdom, and are detrimental to the useful bacteria. The effect of their more or less complete destruction was to leave the bacteria (through their spores) in possession of the field, and this was followed by a rapid increase in their numbers, and an increased degree of fertility in the soil.

These remarkable results throw much light upon the wonderful nature of the soil, but they have also important practical bearings. Especially do they give a new meaning to the action of heat, whether from the sun, or applied to the soil in the operation of clay burning, paring and burning, or stife-burning. They also explain the benefit which follows the burning of furze, grass, and other herbage, which is not entirely due to the sprinkling of ashes over the surface, but to the destruction of protozoa and the subsequent increase of useful bacteria. Tropical sunshine has a similar effect to applied heat, and it is not improbable, but extremely likely, that a hot summer, such as occurred in 1911, may be highly beneficial to land even in our latitude. The degree of heat concentrated upon a square yard of fallow during a long summer day is almost unbearable, and the



FIG. 6.—A, chain of bacilli with spore in each cell; B, cells of genus *Clostridium* with spores; C, germination of spores.

effect upon the protozoa in the first 6 inches of soil may be as detrimental to them as the action of antiseptics—for the complex rays of sunlight are antiseptic, although less powerful than Röntgen rays.

**Physical Properties of Soils.**—Schübler laid the foundation of this section of agronomy in 1838, by an exhaustive investigation into the physical properties of sand, clay, lime, and vegetable matter. He compared typical examples of each of these proximate constituents with regard to their capability of holding moisture and retaining heat, their absorptive powers, especially as to water; rate of cooling, expansion, and contraction. These researches have been followed up by much more elaborate inquiries, some of which have been touched upon in the preceding pages.

The "complex compound particles", which are an aggregation of various substances rather than of definite chemical substance—coated with organic matter, and containing the principal salts, partly in a liquid and partly in a state of loose combination—appear to have taken the place of the definite double silicate of the older writers as a source of fertility. The soil water, or extract, is a different matter, and the writer presumes that the action of dilute citric and other acids is to detach plant food from the complex particles in the same manner in which the roots disengage them. The soil water may have

done so to a limited extent, but also holds the soluble part of manures and recent dressings. In natural soils there is but little difference between them as to the nature of the watery filtrates obtained ; and we seem driven back upon the complex particles which permanently hold fertilizing matter, for ascertaining the measure of fertility. Unfortunately as yet little is known about them, although treatment with acids and alkalies break them up. On this point Dr. Russell writes : "The properties of a soil are not the sum of the properties of the separate fractions—clay, fine silt, etc." He adds : "It is unfortunate that so little is known about the compound particles, because they play a great part in determining the relations between soil and plant growth. They can be disintegrated by various methods of cultivation, such as ploughing the soil when wet, or by allowing the stock of calcium carbonate (lime) to fall too low, and when this happens the 'clay' properties become emphasized, so that the soil loses its crumbly state, and is very apt to become sticky when wet, and to dry into a hard cake through which young plants can only force their way with difficulty." This, however, is what every farmer knows, and he gains little by the study of complex particles which to some degree are assumed to exist, but about which we know little, even as to their size.

The result of the discussion and investigation so far appears to be that the soil compound particles play a highly important part in determining fertility, a conclusion which is self-evident, even before the investigation is begun. Besides, it may be observed that as ordinary processes of tillage are stated to break-up or assist in the formation of such compound particles, the best method of treating a soil will not be based on such investigations, but upon practice as already carried out. The extreme refinement of the methods of investigation followed seem unlikely to lead to immediate practical results ; but in the meantime the methods employed by good farmers are freely cited by investigators, partly in explanation, and also in commendation, as illustrations of how the soil ought to be treated.

The physical properties of soil have always been the basis of classification to agriculturists. It is in accordance with these physical properties that they are ranged as stiff, light, cold, warm, gravelly, sandy, or peaty. The absorption and retention of water are physical properties, and most agricultural operations are based on the improvement of the physical condition. They are always looked upon as of equal importance with the chemical or analytical aspect ; and efficient drainage has most properly been regarded as of prime importance. It is only of late years that agricultural chemists have realized the importance of the water economy of soils, but now they seem inclined to attribute almost everything to it. The old chemical analyses of soils are discarded, thereby justifying farmers for their small interest in them in times past ; and more stress is now laid on "complex particles" which can neither be measured nor valued, except by crop results.

We have progressed in knowledge without coming to any positive conclusions, except that bad cultivation is a bad thing, but the reasons

are couched in almost unintelligible language. "Clay is an electro-negative colloid, its reaction probably being conditioned by a trace of potash liberated by hydrolysis. It shows the general properties of electro-negative colloids, as elucidated by Schulze and Hardy; thus it is flocculated only by a solution containing ions or particles of opposite electric sign, and the extent of flocculation increases rapidly with the valency and concentration of the ion." This is somewhat strong meat for agriculturists, and bears out the impression that "the subject is now in rather a confused state" and a little outside the interests of agriculturists.

**Distribution of Soils.**—So far as distribution is concerned soils are found in every part of the world, except where bare rocks form the surface; that is, if sea-sand or sandy deserts can be called soils. To this there seems no objection, as even Sahara is fertile when water is present, and the barrenness of many soils is as much due to climate as to composition. Barrenness may, in fact, be regarded as the extreme left of a series, in which great fertility constitutes the extreme right. There are, however, many other factors than barrenness and fertility, and these are closely related with geology. The rocks which compose the crust of the earth are chiefly calcareous, argillaceous, and arenaceous; existing as chalks, limestones, marbles, clays, marls, sandstones; slates, conglomerates, granites, green stone, etc., all of which yield soils of more or less distinct character. A geological classification was therefore early attempted, and there can be no doubt that the character of the rocks are reflected in the soils derived from them. Soils, as already remarked, are by no means always *in situ* with regard to the block geology of the country, and surface maps are much more complicated than the main geological features. They are, in fact, extremely puzzling, so that most farmers are content to describe soils in their own language; while at the same time such distinct varieties as the Upper Chalk, the London, Kimmeridge, Oxford, or Lias Clays, are recognized.

It is not thought necessary to follow all the series of rocks which successively crop out to the surface from the South-East to the North-West of England. They are extremely interesting, and in many cases very distinct. They are marked by well-defined features, from the cliffs of Dover and the downs of Kent and Sussex, to the mountains of Wales and Westmorland. From London the traveller passes through the rampart of chalk hills which surrounds the capital, over the extensive deposits of the Upper, Middle, and Lower Oolites, the Lias Clays, the New Red Sandstone, the Coal-measures, the Mountain Limestone, to the Wenlock and Welsh Mountains, and the cliffs which overhang St. George's Channel. Plains and escarpments mark the boundaries of successive formations, and alterations in cultivation and live stock accompany these changes. The subject is indeed fascinating, and the only reason it is not fully described in these pages is want of space.

It must, however, be confessed that all attempts to classify soils upon a geological basis have failed. The writer once undertook to construct mixtures of grass seeds on a geological principle, but the exceptions were too numerous, and the changes in soil too great

(owing to surface interruptions) to render the scheme practical. Soils are often formed of drifted matter from a distance ; of eruptions of lava at a remote period ; of peat, and of alluvial deposits by the sides of rivers, or following old coastlines. In all such cases the main geological features are masked, and surface maps become necessary. Mr. A. D. Hall of the Development Commission has done excellent work in this direction, and its extension over the whole of England would be a proper object for expenditure of public money. Such maps should carry figures showing elevation above the sea, local rainfall, average size of farms and rents, population per square mile, live stock per 1,000 acres, average yields of wheat, barley, and oats, and other data for measuring fertility.

**Slight Sketch of the Principal Formations.**—Notwithstanding constant interruptions, the principal formations present well-marked characters where they actually constitute the surface. The student is, however, often inclined to expect too much, and to generalize from the name of a particular formation. Further study shows that the Weald Clay is interspersed with beds of Hastings Sand, which falsify first impressions ; and the London Clay, which is properly described as of tenacious character and bluish-grey colour, is often covered with Bagshot and Thanet Sands, which occupy extensive tracts in Surrey and the New Forest in Hampshire. Many similar

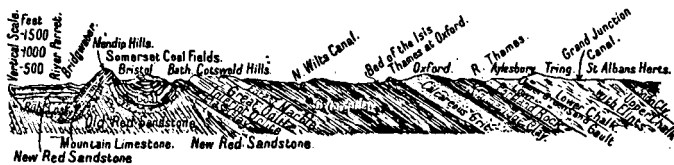

FIG. 7.—Geological Section from Hertford to Bridgwater.

cases might be given, showing that a minute knowledge of all the strata is necessary before judgment can be formed as to the geological relations of a locality (e.g. Hertford to Bridgwater, Fig. 7).

As the "geological staircase" commences with the most recent formations and descends to the most ancient, we naturally find what are termed "recent" formations placed first. The term "recent" in a geological sense may be remote from historical times, but may also include soils of modern origin, or even now in course of formation. Recent soils are not confined to any particular part of the country, but their greatest development occurs in the Eastern Counties, where they form the alluvial tract of Holderness in South-East Yorkshire, North Lincolnshire (Grimsby), and the fens and marshes of Cambridgeshire, South Lincolnshire, Huntingdon, and several other counties. Similar tracts occur in Somerset and Lancashire, and in a less degree follow the course of all rivers and estuaries.

The London and Plastic Clays are closely contiguous, and occupy two important areas in which London and Southampton are the most important centres. From London this clay extends almost to Marlborough in Wiltshire, which may be taken as the apex of a vast

triangle, extending northward to the Suffolk coast and southward to Thanet in Kent. North of Southampton another development extends to Salisbury, which is the apex of a triangle in which the base is the coastline from Bognor to Weymouth, including the New Forest.

The Chalk formation finds its most northern limit at Flamborough Head on the Yorkshire coast, and extends inland as the Yorkshire Wolds. It then crosses under the bed of the Humber and appears as the Wolds of Lincolnshire. It rises again on the south of the Wash as the Chalk downs of Norfolk, Suffolk, and Essex, and once more south of the Thames estuary as the downs of Kent, Sussex, and Surrey. It enters Hampshire and Wiltshire as high-lying downs, and finds its western limit in Dorsetshire. Salisbury Plain is the central plateau of the Chalk, and thence it sends out arms to the south, east, and north, covering a portion of no fewer than sixteen counties.

There is a great similarity in the soils of the Chalk wherever met with, as well as in the character of the farming. The Upper Chalk abounds in flint stones, is undulating, and traversed by numerous valleys of denudation, often devoted to irrigation. The farms are large, and the land is light, grateful, and well adapted for sheep-folding. Every Chalk county at one time boasted its own breed of Down sheep, so that Essex, Kentish, Sussex, Hampshire, Wiltshire, Dorset, Oxford, Berkshire, and Suffolk Downs were familiar names to every sheep-farmer. The number of these breeds has diminished, but only because they have become merged in three or four leading races.

The Lower Chalk occupies the northern and western flanks of the downs, but on account of the sinuous course of the formation may occur in opposite directions. The soils are stiffer and richer than those of the Upper Chalk, and are free from flints. They form fine fertile tracts around Ludgershall and Warminster and at Didcot. They are bounded along most of their margins by the Upper Greensand, which may be seen marked green on all geological maps, following its outcrop from under the Chalk. It forms soils of exceptional fertility in combination with the Chalk marls. It produces hops at Farnham and in Kent, and is the basis of market gardens at numerous points. It offers a striking contrast to the Lower Greensand, which develops into wide and barren heaths in Kent, Surrey, Sussex, and Devon.

Separating the Upper and Lower Greensands is the Gault Clay, of blue impervious character. It is found at Sevenoaks in Kent, and in Cambridgeshire and Huntingdonshire, etc.

The most characteristic formation in the Lower Cretaceous system is the Weald of Surrey, Sussex, and Kent. It lies between the North and the South Downs, and forms a beautifully wooded tract, diversified by pastures and arable land. The sands of Folkestone, Sandgate, Hythe, and Hastings, above and below the true Weald Clay, produce light soils; while the clay itself is fine-grained and difficult to manage. This is the native county of the Sussex breed of cattle, and offers a good example of the influence of main geological features upon agriculture.

The Oolite is an enormous system composed of limestone rocks alternated with deep beds of clay. It cannot be described as a whole, and is best indicated by a schedule showing its main division. It finds its northern limits on the Yorkshire coast, north of Flamborough Head, and south of Saltburn, where the New Red Sandstone takes its place at Huncliff. It extends through Yorkshire (Cleveland Hills), Lincolnshire (heath district and clays), Northamptonshire (grazing districts), Bucks, Oxfordshire (Oxford Clay), Gloucestershire (Cotswold Hills), North Wilts, Somerset, and Dorset, where it reaches the coast. The character of the soils corresponds with the nature of the various rocks, as the following list of the principal parts of the system indicates :—

UPPER OOLITE	{	Purbeck Beds (Isle of Purbeck in Dorset ; light soils).
		Portland Stone (famous for quarries ; light soils).
		Kimmeridge Clay (forming excellent pasture ; heavy land).
MIDDLE OOLITE	{	Coral Rag (light land).
		Oxford Clay (much poor clay pasture).
		Kelloway Rocks (light land).
LOWER OOLITE	{	Cornbrash (yielding a free-working and fertile soil).
		Forest Marble (heavier soils of moderate fertility).
		Great Oolite (limestone soils of moderate fertility).
		Stonesfield Slate (supplying characteristic but heavy roofing).
		Fuller's Earth Clay (a fine-grained clay and important water bed).
		Inferior Oolite (Cleveland Hills and higher portions of the Cotswold Hills ; unproductive).

The Kimmeridge and Oxford Clays form tracts of variable fertility, in which the Kimmeridge Clay is the more productive, and it will be seen that the entire Oolite formation is divided between clays of great depth, and thick bands of limestone, which yield soils of lighter character. This is well seen in the alternation between Portland Stone and Kimmeridge Clay ; Oxford Clay, lying between the Coral Rag and the Kelloway Rocks ; Forest Marble, between Cornbrash and Great Oolite ; and Fuller's Earth, between Great and Inferior Oolites.

The Lias formation rises to the surface upon the north and west of the Oolites, and has sometimes been included in that system. In many cases the deep valleys of the Inferior Oolite cut down into the Lias, and in this way highly picturesque scenery is produced in Warwickshire and the neighbouring counties. The Lias is also divided into Upper, Middle, and Lower, but the main agricultural feature is its clayey character. It has been said to be the last extensive and continuous clay, but this is of course inaccurate, although it may be accepted in a qualified sense. The Lias Clay traverses England from north-east to south-west. It forms the clay lands of Cleveland in Yorkshire, passes Thirsk, Notts, Burton, and Newark ; forms the Leicestershire grazing districts, passes Rugby, and forms part of South Warwickshire and most of Worcestershire ; the rich district around



Evesham and Tewkesbury to the Severn ; and reappears as rich land in Somersetshire. The Vales of Gloucester, Evesham, and Berkeley rest upon it, and it forms dairy districts in all these counties. As in all formations, the soils of the Lias vary so that it is unsafe to predict the nature of the land on geological grounds.

The New Red Sandstone or Trias succeeds the Lias in a northern and westerly direction, appearing first, as already mentioned, at Huncliff (Redcar), Saltburn, and underlying good land in North Yorkshire. Another development occurs around Carlisle, although separated from the main formation. The River Tees flows over its red rocks, and on the Yorkshire side has produced a fertile district. The Vale of York is a continuation, but is of varied character, sometimes clayey and sometimes blowing sand, as at Heckington. It is marked with peaty and alluvial deposits at Howden and around Selby ; yields light loams in West Notts, and forms the garden of Derbyshire south of the Peak District. It yields soils of high fertility in West Leicestershire and Warwickshire, and excellent land in Worcestershire, Salop, Cheshire, and West Lancashire. It is either the site of or abuts upon the coal-fields of Durham, Yorkshire, Lancashire, and the Midlands, and is interrupted in its agricultural character by the Potteries of Staffordshire and the "black countries" devoted to coal-mining and manufacture. The soils of the New Red Sandstone are red in character, and vary from light soils to marls.

The Permian or Magnesian Limestone occupies the coast between Sunderland and Shields, and forms a tract of low hills in the county of Durham, notably around Aycliffe and Ferryhill, where there are many lime-kilns. It forms low hills at Pontefract and Wetherby, and the formation then narrows and passes southwards through Yorkshire, ending at Nottingham. It occurs nowhere else in Britain, and is our only example of dolomite or pale-yellow magnesian limestone. It is considered too hot in its nature for application to land, but is in high esteem for smelting iron and for plastering. It is also used in the manufacture of steel and appears in basic cinder.

The Coal-measures come next in order, and consist of alternate beds of indurated bluish-black clay (coal shale) and siliceous sandstone (Millstone Grit and Post), and the soils are often of inferior agricultural quality. The Coal-measures abound in large towns such as Newcastle, Durham, Sheffield, Birmingham, Wolverhampton, Bristol, Manchester, Liverpool, and many others.

The Millstone Grit fills up the space between the Yorkshire and Lancashire coal-fields, and covers a considerable tract in Yorkshire, Durham, and Lancashire. It forms another tract in Central and North-West Derbyshire, runs into Cheshire, and touches the North Staffordshire coal-fields. It also occurs in Cornwall and Devon. It often forms uncultivated tracts of high-lying and rolling country (fells), much of which is under larch and Scotch fir. When cultivated, these soils yield free-working land, of somewhat coarse sandy texture, with fragments of felspar interspersed throughout the mass.

The Mountain or Blue Limestone rises from below the Coal-measures to the west and north, and forms the greater part of Northumberland, a considerable portion of West Durham, Yorkshire,

and Derbyshire. It extends towards Allenheads and forms an enormous tract of sheepwalk extending from Northumberland, through the moors of Durham, Yorkshire, and Lancashire, into Derbyshire Peak District. Much of the land is unfenced, and it used to be said that a black-faced sheep might travel right through these moors from Northumberland to Derbyshire.

Below the Mountain Limestone is the Old Red Sandstone, which appears in the Lowlands of Scotland, notably as the rich red potato soils of East Lothian. It is essentially a northern and western formation, occurring as far north as Inverness, where wheat may yet be grown. It occurs in various parts of Scotland, and reappears in England as fruitful land in Hereford, where hop-yards are found. It is also found in Devon, Cornwall, and Monmouth. The soil is considered to be particularly rich, but this is only true of the middle strata, containing concretionstones, marls, and limestones. The upper and lower portions are composed of red and yellow sandstones, conglomerates, slates, and tilestones, and the lower series are mostly of flagstones, tilestones, limestones, and conglomerates. These are not fertile, and often rise to high elevations, as at May Hill in Herefordshire. They also compose much barren and unreclaimed land in the North of Scotland. The soils of the Middle Devonian are, however, often extremely rich, and sometimes command rents of £5 per acre.

The remaining formations lie outside agricultural England and Scotland. They are the Silurian, Cambrian, and Laurentian Systems, which form the mountains of Wales, the Lake District of England, and the Highlands of Scotland.

The above is a very slight description, but is meant to be suggestive rather than exhaustive. It will be seen that some formations produce rich, and others poor soils; some heavy clays, and others light arable land, adapted for winter folding with sheep. If a line be drawn from Berwick-on-Tweed to the Isle of Wight, most of the arable land of the country will be found on its eastern side, while west of it will be found the principal manufacturing-centres and coal-mines. The west country is also more devoted to grazing than to corn-growing, and becomes mountainous and rugged. The east coast is low, flat, and rounded in outline, while the west coast is precipitous and rugged. In the North of England, where the cliffs of the Mountain Limestone abut upon the North Sea, the scenery is similar to that of the west coast.

The relations between the block geology of the country and agriculture, as already stated, are not always reliable. The "Great Northern Drift" covers many districts which might otherwise have been composed of rich New Red Sandstone soils. This is well seen on the north side of the Tees in the county of Durham. Rivers often form alluvial tracts on either side of their course, and there are also extensive tracts of alluvial soil which have been reclaimed from the sea on both the east and west side of the country.

Peat also is liable to interfere with main geological features, and, as previously insisted upon, there is a great need of surface maps.

**Classification of Soils.**—The classification of soils necessarily depends upon the predominance of clay, sand, lime, and vegetable

matter, which either stamp them as belonging to one or other of these four divisions or as being of mixed character partaking of the nature of all. The latter are loams, which are again divided into sandy, clay, calcareous, or vegetable loams.

Schübler followed the system adopted by naturalists in dividing soils into classes, species, and varieties; but there is an evident want of that close similarity which exists among plants and animals or even minerals of the same kind. Any classification of soils must therefore be held loosely. The individual character of each soil almost makes it a species in itself, and every one who has managed land knows that soils vary every few yards. A classification upon an allegorical principle finds currency among farmers, and it is curious to notice how certain classes of soils fit in with human characteristics. Thus soils are often correctly described as grateful, free, tenacious, sour, stiff, kind, tempery, weak, strong, hungry, fat, thin, exhausted, rich, and poor. It is doubtful if any better description could be given than by a selection or combination of some of these expressions. Thus any farmer would understand what is meant by a poor, weak, hungry soil, and appreciate the difference between it and a strong, rich, and fat soil. These allegorical descriptions are all based upon the varying proportions of the materials which compose soils, and in order to be precise a brief outline may be given of Schübler's classification.

- (1) The argillaceous or clay group always contains above 50 per cent of "clay".<sup>1</sup> This Schübler divided into clays without lime, and clays with from .5 to 5 per cent of lime, and these again into poor, intermediate, and rich. Hence there are at least six sorts of argillaceous soils.
- (2) Loamy soils containing from 30 to 50 per cent of clay, and these again are divided into loams containing from .5 to 5 per cent of lime, which were again classed as poor, intermediate, and rich.
- (3) Sandy soils containing from 20 to 30 per cent of clay, and, again, with from .5 to 5 per cent of lime. These also were divided into poor, intermediate, and rich.
- (4) Loamy sands, containing 10 to 20 per cent of clay.
- (5) Sandy soils, containing under 10 per cent of clay.
- (6) Marly soils, comprising all soils containing above 5 but under 20 per cent of lime. Marls are described either as argillaceous, loamy, or vegetable, according to the proportions of clay, sand, or vegetable matter they contain.
- (7) Calcareous soils containing over 20 per cent of lime.
- (8) Vegetable soils, or those containing over 5 per cent of vegetable matter.

These are the eight notes of Schübler's gamut, evidently capable of producing any number of variations. It must, however, be pronounced impracticable, although useful as an indication of the principal groups into which soils may be divided. Schübler's criterion as to the three degrees of fertility was, that a poor soil contained

<sup>1</sup> The word "clay" is unfortunate, as it represents a crude native material containing silt and fine sand rather than the colloid substance which binds them together.

ORIGIN, COMPOSITION, AND DISTRIBUTION OF SOILS. 27

from 0 to .5 per cent of vegetable matter, an intermediate soil from .5 to 1.5, and a rich soil from 1.5 to 5 per cent of the same. Any excess of humus over 5 per cent transferred a soil into the class of vegetable soils.

**The Subsoil.**—No classification of soils is of use unless it takes the subsoil into account, for it is evident that a clay resting on sand or gravel, or a sand resting on clay, are very different from a clay resting on clay, or a sand of open character resting on a subsoil of similar open character. The water economy is also of such vast importance that no soil can be described as poor, intermediate, or rich, until its relations to water are fully known. Hence the classification of soils is a highly complicated subject from which little light can be gained, except as regards the particular soil under examination.

Any system must be on broad lines, and the main divisions of Argillaceous, Arenaceous, Calcareous, and Vegetable will remain as the basis upon which any useful classification must rest.

## CHAPTER II.

### AIR AND WATER.

THE dependence of vegetable life upon the atmosphere is liable to be overlooked by farmers in their close attention to the soil. Every farmer, however, thoroughly appreciates the importance of the weather, or of meteorological conditions; and this alone causes him to look upwards as well as downwards. The atmosphere extends to an unknown distance from the earth. It is subject to the law of gravity, and exerts a pressure of  $14\frac{1}{2}$  lb. on every square inch of the earth's surface, diminishing with the altitude, until it either disappears entirely, or may be sufficient to preserve a surface and thus make an aerial ocean.

The air is a mechanical mixture of oxygen and nitrogen in the proportion of 20.65 to 77.11, the remainder being made up by carbon dioxide .03, argon .79, watery vapour, variable, and traces of hydrogen, ammonia, nitric acid, and several less-known and recently discovered gases, all moving freely within its wide limits. Whether any part of our atmosphere escapes into space is a matter of speculation, but the moon has lost hers, and it is probable that there may be some loss of ours during long ages of time. The air performs many functions besides supplying breath to animals and food to plants. Actually, the whole of the tissues and structures of plants are derived from it, except the small residue known as ash. This may not be quite true of the whole of the nitrogen and carbon, for nitrogen is supplied by the soil, and carbon is absorbed by roots in the form of carbonates and carbon dioxide. This nitrogen is, however, derived from organic matter, and was probably originally derived from the air. Nitrogen occurs in sea-water, in beds of sodium and potassium nitrates, in drainage and soil-water, but generally seems to have had an organic origin; and, if so, we may hold that originally it came from the air, and it certainly returns to it in the processes of combustion. The ash then alone represents materials derived from the earth, but this view does not detract from the importance of adding nitrogenous manures to the soil.

Before dealing with air as a source of plant food, it may be well to briefly consider its uses in other capacities. First, it is the air which makes rain possible, but gaseous water, or vapour, is as necessary as actual rain. Evaporation proceeds most rapidly in hot air, and, conversely, moisture is deposited as dew from cooling air. The amount of moisture in the air depends upon its temperature:

thus, at 32° F. the air holds  $\frac{1}{100}$  of its weight of water, at 59° F. it holds  $\frac{1}{50}$ , and at 86° F.  $\frac{1}{20}$  of its weight. Conversely, as the temperature falls the watery vapour condenses, and is deposited on any cool surface. On a cold night, after a warm day, the pattering of drops may be heard in woods, distilling from twigs and leaves. Rain is caused by condensation aided by electrical action. The watery vapour in the air is invisible, and incapable of damping or wetting any material, but when once the temperature falls it is converted into water. In the higher reaches of the air it forms cloud, and at the surface of the earth mists and fogs.

Aqueous vapour checks radiation of heat from the earth at night, and moderates the heat of the sun during the day. Thus, on the Karroo in South Africa, where the air is dry, there is a great difference between the day and night temperature; whereas in Teneriffe, where the air is more humid, and where a blanket of cloud gathers round the peak in the evening, there is only a slight drop of temperature.

There is another function of watery vapour which is perhaps less generally known, namely, the enormous amount of sensible heat given out as it changes its physical state and becomes liquid. It is the precise converse to the amount of heat absorbed and rendered latent when it is vaporized. According to Dr. Huggard, every pound of water that is condensed from vapour liberates heat enough to raise the temperature of more than 58 lb. of lead to its melting-point; and the Rev. Dr. S. Haughton calculated that 1 gallon of rain-water gives out during its condensation sufficient heat to melt 75 lb. of ice (*Popular Science*). The enormous scale on which condensation takes place (one inch of rain per acre represents 224,000 gallons or 100 tons of water) shows the immense amount of sensible heat which must be developed in the atmosphere during the condensation of aqueous vapour into rain.

Not only does watery vapour regulate temperature in the ways already mentioned, but clouds act as screens to the earth, warding off the torrid heat of the sun, and also reflecting back the heat lost from the earth by radiation. Cloudy nights are warmer than clear nights for this reason.

That the entire atmosphere fulfils a wonderful part in moderating the heat of the sun's rays is well known, and is indicated by the coolness of the evenings in summer, which is simply due to the greater depth of atmosphere through which the heat rays must pass when the sun slopes to the west. Vertical rays at midday only pass through the actual depth of the air, but towards sunset they must travel obliquely through a much thicker layer.

Carbon Dioxide (carbonic acid gas) exists in the atmosphere on an average in the proportion of  $\cdot 04$  per cent by volume, or  $\frac{1}{2500}$ . Small as this proportion is it represents immeasurable quantities, sufficient for all growing trees and plants. It is the function of leaves to abstract carbonic acid from the air as it passes over their broad surfaces, and to exhale oxygen while they retain the carbon. Apart from any small amounts derived from soil-water, and the interstitial atmosphere of soils, the carbon dioxide of the atmosphere is the only

source of the carbonaceous matter in plants, as represented by starch, sugar, cellulose, timber, straw, etc. It is probable that at a remote geological period there was more carbon dioxide in the air than there is now, for untold billions of tons of coal and oil, mostly composed of carbon, lie stored up, all of which were abstracted from the air in the Carboniferous epoch.

**Summary.**—The relations of the atmosphere to plant life are therefore by no means simple. They are in some respects analogous to breathing in animals, but there is this important difference—that while breathing is an oxidizing process, in which carbon is converted into carbon dioxide, in plant life (at least under the influence of light) the reverse takes place. It has been shown, however, that the atmosphere is more than food, and is also in a sense clothing. It clothes the earth with a garment, protecting it from the glare of the sun at one time, and moderating the amount of radiation into space at another. It also is the vehicle for evaporation; is the great regulator of climate, cooling the overheated air by converting water from the liquid into the gaseous condition, and warming the cold air by the liberation of latent heat during the process of condensation. Its clouds act directly as moderators of extreme temperature, and rain itself must be regarded as part and parcel of atmospheric action.

It is only through the atmosphere that rivers maintain their perennial flow, that springs continue to bubble up, and that wells are supplied; and yet we can as yet exercise little control over these phenomena. On this ground these pages upon the atmosphere may seem unnecessary to the farmer, but on the other hand they have practical bearings, because climate does not depend only on latitude, but is also controlled by a number of local factors, which are controllable. The air is as important as the soil, and climate varies even upon the same farm, and is affected by many things which are capable of modification. Something might have been added upon the importance of mountains as the great condensers of atmospheric moisture, the sources of rivers, and regulators of climate, but we can at least say that without them the conditions of agriculture throughout the world would be very different from what they are now.

**Climate.**—Climate is the result of a number of circumstances, among which the most general is *latitude*. The Equator is the only part of the earth's surface which does not alter in its inclination towards the sun. There the sun rises and sets vertically, and appears daily at the zenith. As we recede from the Equator either to the north or south, the obliquity becomes more and more apparent. The Polar axis may be compared to a bar passing through from the north to the south pole at right angles to the plain of the Equator. The earth being inclined, it is evident that at both Poles the inclination is at its greatest, and the consequence is that the rays of light and heat from the sun must pass through a deeper layer of atmosphere. In other words, the sun never reaches the actual zenith except at the Equator. In extreme latitudes at certain seasons the sun never sets, and at other times it never rises, giving the long Polar days and nights and the phenomenon of the midnight sun. So far as climate is concerned the sun is the paramount factor in regulating climate,

and becomes less powerful at every degree of latitude from the Equator towards the Poles.

Neither must *longitude* be omitted, although it would not affect an absolutely uniform globe. In our own case longitude is almost as important as latitude, on account of our peculiar position and contour. The West of England and Scotland are warmer and moister than the East coast, and Ireland boasts a still milder and moister climate. The flowers and early vegetables from Cornwall, the early potatoes from Lancashire and Ayrshire, the relaxing air of Somerset and Devon are all connected with longitude. Similarly, the barley and corn cultivation, and bracing climate of the Eastern Counties, their lower rainfall, and the prevalence of arable cultivation are all to be attributed to their longitudinal position. The climate of Bute and Arran is milder than that of Margate on the Kent coast, although these islands and the west coast of Scotland are many degrees further north.

Climate is affected by *altitude* as well as latitude and longitude, on account of the diminishing depth of the atmosphere, its greater rarefaction as we ascend, and its comparative freedom from watery vapour. Thus mountains are always cooler than plains, and a point is soon reached, even in tropical regions, known as the line of perpetual snow. *Moisture* also plays an important part in influencing climate, for moisture arrests much of the solar heat. It however checks evaporation, simply because the air is already saturated with moisture, and hence the heat may be more distressing because it is damp, although actually less intense. A climate is salubrious when the air is sufficiently moist to shield the earth from the full glare of the sun, and dry enough to carry off the exhalations from the skin of animals or the leaves of plants.

Climate is affected by proximity to great masses of water, and islands generally enjoy a milder climate than the interior of continents. The sea retains a more constant temperature than the land, because of its uniform degree of warmth in summer and winter, and ocean currents, such as the Gulf Stream, exert a strong influence upon the climate of the coasts on which they impinge. Thus we enjoy a much warmer climate than we are entitled to in our latitude, which is practically the same as that of Labrador and Newfoundland.

**Weather and Climate.**—A distinction must always be made between weather and climate. Weather is influenced by a variety of circumstances which cannot be said to affect the general climate. All countries are subject to fits of bad weather—sometimes in the form of protracted droughts, and sometimes of long continued rains, or it may be of hurricanes and other disturbances. Britain is favoured with a wonderfully temperate and salubrious climate, but its weather is proverbially fickle and often atrocious. The British climate is especially favourable for the highest development of all kinds of live stock, partly on account of its uniform temperature, but also because it is adapted for the production of food suitable for the animals maintained. The climate reacts upon the soil, so that a high average yield is maintained both as regards grain and fodder crops. The quality of the food produced is also exceptionally good, although our



insular pride may rate it too highly. Be that as it may, it is commonly thought that no potatoes are so good as those of English growth; no vegetables so well flavoured, no barley, oats, or beans so satisfactory. The British climate is one of the things of which we may be proud and thankful for, but the weather is a very different matter.

**Reasons for our Uncertain Weather.**—So uncertain is our weather that it may truly be said that we never know what to wear, and whatever we wear we are almost certain to be wrong. This uncertainty is due partly to our being an island, but also to the position of that island on the borders of the vast Atlantic Ocean and its wonderful Gulf Stream. The disturbances which are constantly sweeping over us are caused by winds charged with moisture, which, as they encounter the mountains of the west, precipitate rain through condensation of vapour.

The consequence is that all the western counties are wet and warm, and all the eastern counties comparatively dry and cold. We are

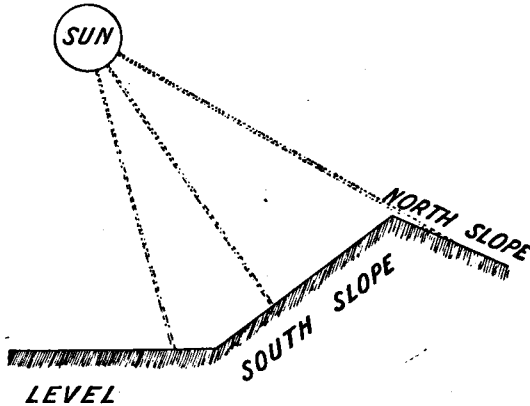

FIG. 8.—Distribution of heat and light of sun's rays on the soil according to the inclination of the land.

liable to floods and wet seasons; but when anticyclonic conditions set in, to prolonged droughts and tropical heat. On the whole our climate is temperate, but there is often too little summer, and our winters are in some cases almost as warm.

**Aspect.**—Climate may be considered locally as well as generally, and is much influenced by aspect (Fig. 8). A slope towards the south and a rampart of hills on the north may completely alter the climate of a district. A northern exposure, the proximity of marshes or sluggish rivers, or of mountains, produce an opposite effect within a very few miles; and hence the importance of a favourable aspect. The nature of the soil is also important, for clays are naturally cold and damp, while sands and gravels are as naturally warm and dry; and these characteristics influence the climate both for men and animals. Much more might be written upon Aspect in its relations

to farming, but there will be opportunities for enlarging upon its importance in discussing particular crops and special breeds of stock. We therefore pass on to consider certain points in which an artificial aspect may be created, and this takes us to Shelter.

**Shelter.**—This is sometimes provided naturally, in which case it is a matter of aspect. It is, however, quite possible to improve upon nature in this particular. Trees may be planted, which, as Pope wrote, "Teach the ambitious hill to climb," and thus further increase its sheltering influence. Bogs may be drained, and fences erected to break the force of sweeping winds. These are matters more likely to engage the attention of extensive proprietors than of farmers, but in a smaller way much may be done on farms. Homesteads are generally built in sheltered positions, but their comfort may be increased by planting trees on the north side. Every one knows the great difference between the north and the south side of a garden wall, and a coping of thatch or slate greatly improves a wall for fruit-growing. Not only is wall fruit dependent upon its exposure to the sun, but the protected beds under the lee of a wall are earlier and more prolific. Walls having a southern aspect are, of course, more for gardens than for fields; but something analogous is successfully attempted in districts in which delicate crops are cultivated.

Shelter is often the cause of tropical heat in cultivated fields where the sun pours down its rays upon vegetation protected from all wind. Any tall growth serves the purpose of protecting delicate plants which might at first sight appear scarcely fitted for English growth, and among the best extemporized fences are artichokes, hemp, and rye. A triple row of rye does not occupy more than 24 inches in breadth, and on good land will attain a height of 6 feet. If it is drilled from east to west it cuts off the north wind, but the best direction is from south-east to north-west, as this ensures the full effect of the afternoon and evening sun. By this system land may be divided into panes of any required width, but 8 to 10 feet is wide enough for securing the maximum amount of shelter from cold winds, and the minimum amount of shadow. Shelter is as important for live stock as for crops, and many expedients may be used for securing a sunny and sheltered aspect for poultry, calves, or fattening bullocks (see *Farm Buildings*).

Aspect and shelter should also be noted in choosing a farm or in fixing upon any particular breed of stock. Fields with a southern slope generally produce better barley than those facing north, and harvest also may be earlier. The slope of land towards the south shortens shadows, while on northern and eastern slopes the trees towards evening stretch their shadows over many acres. The length of a shadow is the measure of the distribution of heat as well as light, and to double the length of a shadow is to halve the amount of both.

## CHAPTER III.

### TILLAGE, AND PHYSICAL IMPROVEMENT.

WHEN land is first reclaimed from its natural condition it is rich in stored-up plant food, but unfit for ordinary cultivation. If it has been covered with trees and brushwood these must be cleared, stubbed, and burnt; if in prairie, there may be surface obstructions and land-fast stones. If reclaimed from the sea, salt is to be reckoned with, and time must be allowed for it to be washed out; and if from lakes or bogs, the soil is often sour from semi-decomposed organic matter, want of the oxidizing power of the air, and the presence of protoxides and sulphides.

The legend of virgin soil of enormous fertility is founded upon actual cases, but at the same time newly broken-up land is not always fertile. It is well known to practical men that derelict land is often poor, notwithstanding a long period of rest; and that it requires some years of cultivation before it regains its fertility. All these cases show the importance of tillage, which may be defined as pulverization and exposure to atmospheric agencies. The organic matter must be changed from a turfy and fibrous character into mould, and the land must be consolidated, and rendered less hollow and puffy.

That soil improves under cultivation is quite as true as that virgin soils are rich, and we know that the soils of England are much richer now than they were in the fifteenth century, when the average yield of wheat was 8 bushels per acre, and land was rented at from 2*d.* to 4*d.* per acre.

Tillage is a wide term, and may embrace a good deal beyond mere ploughing and harrowing. It may, for example, include drainage, subsoiling, clay-burning, and applications of lime and manure, each of which may be necessary before ordinary tillage operations can be carried on with success. It is known as a matter of practice that waterlogged land cannot be effectively tilled, and hence drainage becomes an initial necessity. This operation alone would require a treatise in order to do it justice, and for the present we can only emphasize its importance. It may, however, be stated that the object of drainage is not to deprive soil of moisture, but to establish a free circulation of water from the surface to the outlet. Water-meadows demonstrate the value of water, and irrigation at first sight appears to be the precise opposite of thorough drainage (Fig. 9).

The fact is, however, that both aim at the same result, namely the movement of water through the soil, bringing its vivifying

properties to bear upon roots. Stagnant water soon loses the oxygen which is dissolved in rain, and becomes charged with the products of decay. It renders the land sour, and prevents rain from soaking through the soil and taking its place. The expression "waterlogged" conveys the idea of permanent wetness, unrelieved by change. When, however, movement is introduced by the opening of underground channels in a system of drains, the pent up and effete water is liberated, and rain readily soaks through the soil. Fresh accessions of rain actually squeeze out the previous falls, and thus the land is constantly refreshed by new stores of revivifying water. Waterlogged land is also impervious to air, for the pores of the soil are

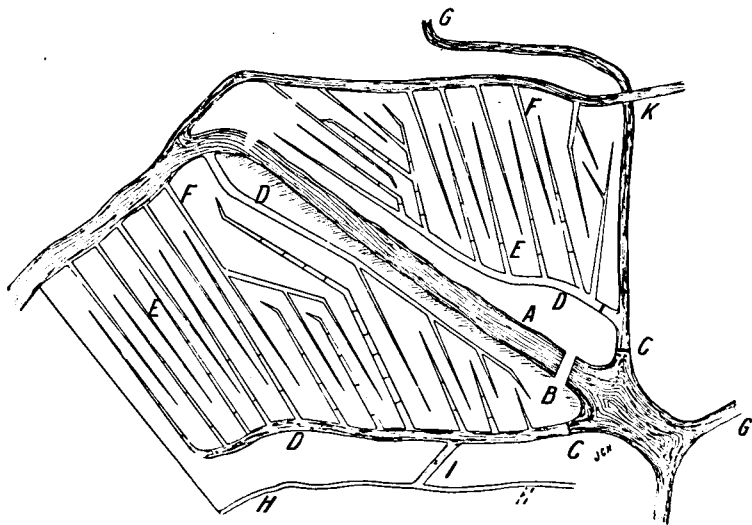

FIG. 9.—Irrigation of a Water Meadow. A. main water course; B. dam; C. sluices; D. conductors; E. feeders; F. drains; G. conductors to other fields; H. back drains to cut off springs; I. waste-water drain; K. carry bridge.

already blocked. The effect of drainage is to allow air to enter, which it must do of necessity, on account of the pressure of 14 to 15 lb. per square inch exerted by the atmosphere at the earth's surface. If air did not enter the soil the drains would refuse to run, but the scientific view is that the pressure of the air pushes the water through the soil, and into the drains. The air also is mechanically pressed into and through the soil, and the conclusion is irresistible that wherever water sinks through soil or subsoil air must follow, unless there is a vacuum. The idea that it is of importance that soils should be thoroughly aerated is no doubt true, but the close relationship between drainage and aeration is liable to be forgotten. In most soils drainage is provided for by pervious

subsoils and a natural outfall, either into subterranean water-bearing strata or into brooks and rivers. Such soils require no artificial drainage, and probably no artificial aeration. It is only waterlogged soils which require the drainer's help.

The effect of drainage on temperature is important. It even affects climate, when carried out upon an extensive scale, as in the Fens of Lincolnshire, where it has been followed by the disappearance of ague and other diseases. The removal of large areas of stagnant water, either above or immediately below the ground, must diminish fogs and dampness; but equally important is the checking of evaporation, which removes heat and causes chilliness, not only of the soil but of all bodies exposed to it. Evaporation takes place from the surface, and a dry top soil arrests its action to a considerable degree. The temperature of drained soils has been ascertained by thermometrical tests to be 10° F. above that of undrained soil at 7 inches below the surface. As this rise is the same as the difference between the mean temperatures of January and May the importance of drainage as a means of increasing the underground temperature can scarcely be overrated. It also has important bearings upon the cultivation of the less hardy crops, the date of harvest, the health of live stock, and the prevalence of blights on growing crops.

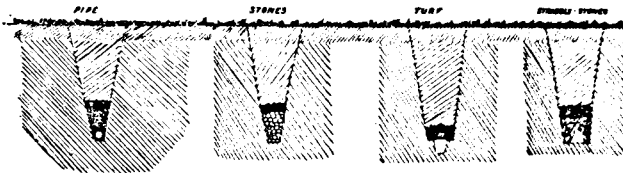

FIG. 10.—Types of Drains.

Drainage is the foundation of successful tillage, whether effected naturally by porous subsoils or pipes (Fig. 10). The material employed matters not as long as it is effective, and is not impeded at the outfall (Fig. 11). It may be a deep layer of gravel, of fissured rock, of porous soil, whereby the water finds its way to feed springs, supply wells, or flood lower levels. The percolating water must not, however, accumulate over an impervious clay-bed near the surface, or it will rise as a "table" to, or near, the surface. In such cases a vent must be opened, and the water given free outlet. This is the principle of irregular drainage of which Elkington was the exponent. In this system a single drain has been known to lay dry a considerable area of wet land.

Clay soils of great depth are waterlogged chiefly through their retentive nature, which presents an obstacle to the free passage of either water or air. These soils require a regular system of drains (Figs. 12 and 13), as originally recommended by Smith of Deanston in Perthshire, who advocated thorough and furrow drainage. Both these systems are almost classical as regards the literature of the subject, but they embody the two leading principles which guide drainers of agricultural land.

There is another aspect of drainage which is not quite so important agriculturally as thorough drainage, but even more so nationally, and that is trunk drainage or the regulation of the outfalls of streams and rivers, and, in a word, facilitating the passage of water towards the ocean. With this we have little to do at present, except as it concerns flooded lands, which suffer from the artificial drainage of higher tracts, and require to be freed from water by improving the carrying power of the natural outlets.

*Subsoil ploughing* is another tillage operation which is required in certain circumstances. It becomes necessary when an impervious pan prevents the downward passage of water, roots, and air. These pans may be of ferruginous character, as when iron salts from decaying heather roots bind mineral matter together in the form of a concrete. They form a "band" of one or more inches in thickness which require to be broken by a powerful tine or tooth, known as subsoiling. It may also be effected by a knife or coulter attached to the frame of a steam plough, and in this case it is simultaneously effected with ploughing. Subsoiling does not aim at bringing the subsoil to the surface, but in rendering it permeable to water, and from this point of view it may be regarded as supplemental to draining. It must not be confounded with trench ploughing, which brings up the subsoil and mixes it with the surface soil. It was the intention of the early advocates of subsoil ploughing to deepen the staple, but not in so drastic a manner as by trench ploughing. Both operations have been known to do harm as well as good, and both are expensive. They should not be undertaken except on suitable lands—subsoiling where there is a definite obstruction to water, air, and roots; and trench ploughing where the soil is naturally deep and only requires to be weathered in order to be equally fertile with the surface soil.

*Mixing Soils* has often been undertaken with success. It may take the forms of claying or of marling, both operations being beneficial to sandy soils. It may be effected by carting 40 or 50 cubic yards of clay or marl per acre as a first application, and repeating the operation after an interval of years. Claying is sometimes accomplished by opening trenches a few yards apart, down to an underlying

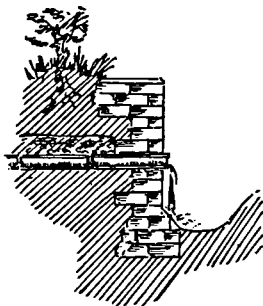

FIG. 11.—Drainage outlet.

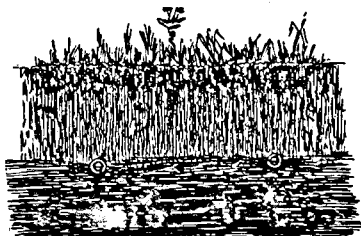

FIG. 12.

bed of clay, and spreading it over the panes between. This method has been largely practised on the fen lands of South Lincolnshire, where the peat rests upon the Oxford Clay, and has resulted in the formation of highly fertile soils around Boston. It is worthy of notice that a comparatively small amount of clay produces a consolidating effect upon light-topped soils. On the other hand, copious applications of sand are swallowed up by clays without producing much effect. This is due to the colloid principle in clay previously explained by which a small proportion of silicate of alumina is able to segregate large quantities of silt and sand into a mass of clunch, or native clay.

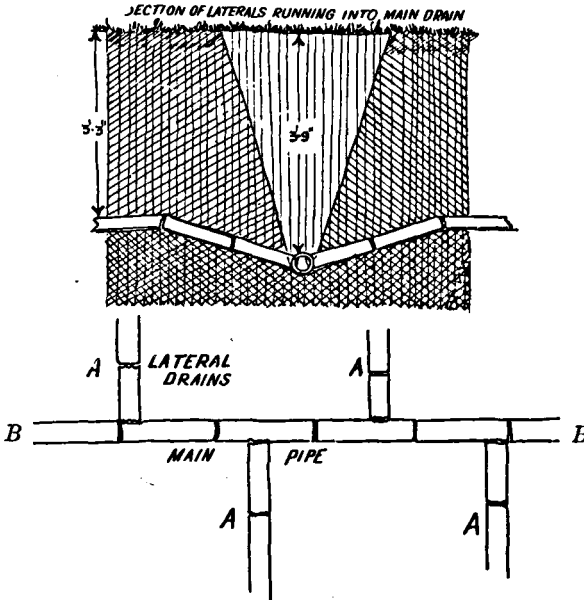

FIG. 13.—Arrangement of Laterals (A, A, A) and Main Drain (B, B).

*Burning* causes the plastic character of clay to disappear, as is seen in bricks, in clay for road-making, and also in the suburbs of London when ballast is being prepared for road foundations, and in pottery. If intended for agricultural purposes, the clay should not be ignited, but kept at a low red heat in large heaps, or clamps, in a state of smouldering combustion, assisted by coal or wood. Great benefit has often followed clay burning, but it tends to diminish soluble mineral matter, and, naturally, dissipates the nitrogen. It has of recent years been demonstrated to affect the bacterial life in the soil in a way which is eventually beneficial. The larger organisms are destroyed, and although the soil is partially sterilized, it is not

completely so. The spores and remaining bacteria are able to develop to a greater degree than previously, and hence, after heating, soil is found to increase in fertility. The ashes of organic matter consumed during burning are also more available for plant food than as root fibres, and hence clay burning, and paring and burning, are good preparations for roots, rape, and other green crops.

*Clay-burning* consists in burning the entire staple of the soil, and follows deep ploughing in dry weather. *Paring and burning* is a surface operation, and is effected by means of a paring plough. The weedy or grassy sod is allowed to weather until it is tender, and it is then well shaken up by harrowing and rolling, and the weeds are placed in heaps, fired, and covered with loose soil. This is "stifle burning", and differs from ordinary open burning in which the weeds only are reduced to ashes.

Paring and burning is used as a means of cleaning land which has laid for some years under sainfoin, or as a first step in breaking up downs. It destroys wireworms and the larvæ and eggs of insects and the seeds of weeds, but, like clay-burning, dissipates organic matter and nitrogen. It is a good preparation for roots, and the organic matter and nitrogen lost in the process are speedily restored by the growing crops, and also by the artificial foods supplied to sheep when consuming them. A further benefit is now known to follow in the partial sterilization of the soil, and the subsequent increase of the bacterial flora engaged in the work of nitrification.

Land drains often become blocked, as instanced by water remaining in pools on the surface; these temporary derangements require immediate attention. During winter all ditches should be scoured, and outlets opened as shown in Fig. 11.

**Ordinary Tillage Operations.**— We now come to what are more generally recognized as tillages, namely, ordinary ploughing, harrowing, and rolling. The object of all these operations is to prepare a seed-bed. It must be of such a character as to encourage germination and the subsequent development of the crop. It must also free the soil from weeds and injurious insects, and preserve the requisite moisture for the use of the young plant. The conditions for successful growth may be thus summarized for all seed-beds:—

- (1) They must be of sufficient depth and fineness.
- (2) They must be moist and permeable to the air.
- (3) Free from injurious salts.
- (4) Enriched, either directly by manuring, or from previous good management.
- (5) Clean, or free from weeds.

It is not easy to secure all these essentials to success, and some of them are antagonistic to others. Thus, in cleaning land, moisture may be sacrificed, and in obtaining fineness at the surface, depth of tilth may be lost.

The plough is the most thorough of all tillage implements, because it completely inverts the whole of the cultivated section. The first 9 inches of the soil is the principal theatre of bacterial action, and contains the largest amounts of nitrogen and available plant food.



It has received manure and the residues of crops for generations, and possesses the power of retaining them. Its store of fertility is constantly recruited from the subsoil by the tap-roots of plants which penetrate it, and bring up both nitrogen and fertilizing salts and raise them above the surface. These are restored to the soil, and hence the tendency is to enrich it. It is in this section that the plough works, and, by repeatedly turning it over, exposes all its parts to the air. It thus stimulates nitrification, which cannot take place without oxygen, and produces the requisite depth of tilth. Implements such as scarifiers or grubbers move the soil but do not invert it, and on stiff soils are liable to produce a shallow tilth and a fine surface, so that in practice the plough is first used to secure a sufficient depth, and the other implements are employed to break the furrow and render the surface smooth and level.

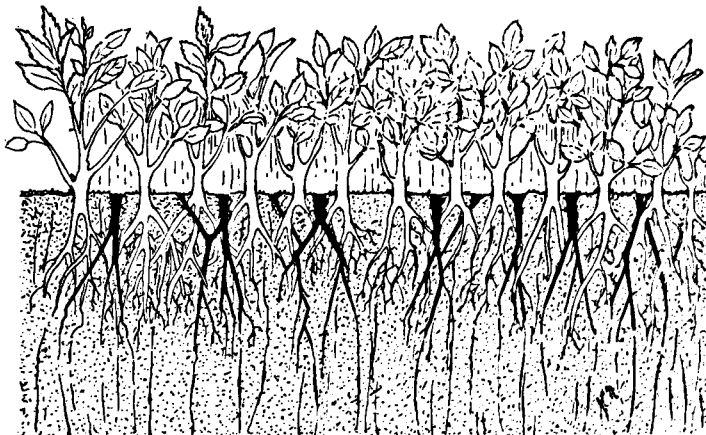

FIG. 14.—Dry cracked soil—unmulched.

The *depth* of ploughing depends upon the character of the soil and the crop about to be sown. So far as the land is concerned the depth of the furrow must depend upon that of the staple. In some cases the soil is entirely different in texture and appearance to the subsoil. If a handful is taken from the top section and kneaded together, it will form a ball of rich brown colour, due to organic matter, and of loose texture. If taken below the plough sole it will be of lighter colour, and will bind together into a compact mass. It is in fact unweathered, and inferior in mechanical condition to the surface soil. To plough up this raw material and mix it with the richer surface soil dilutes the entire mass, and in many cases deluges it with weeds whose seeds have gravitated downwards. The inundation of weeds which so often follows deep ploughing has given rise to speculations as to the vitality of seeds; but it by no means follows

that they have existed for many years in their present position. The annual contraction of the soil in the summer causes cracks, especially on clay soils, which extend to a depth of 3 or 4 feet (Figs. 14 and 15). It is, in fact, difficult to say how deep; but seeds of charlock and other annual weeds no doubt run down them, and lie *perdu* until they are brought up by deep ploughing within the influence of air and light. The subsoil is favourable to deoxidization especially when wet and deprived of air. Sour matter is thus developed, which is not likely if brought up to the surface to improve the top soil, and indiscriminate advice to plough deeply—as if that were the end and aim of good cultivation—is radically mischievous.

Positive evidence is forthcoming upon the disastrous effects of indiscriminate deep ploughing. In one case 3,000 acres were practically ruined or rendered infertile by this mistake. In another recorded case the land was rendered unproductive by sour material

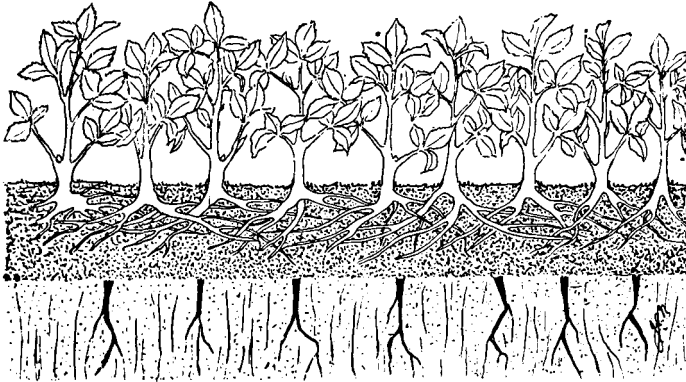

FIG. 15.—Same soil showing effect of mulching.

brought up from below. This is why gradual deepening is recommended, or such an examination of the subsoil as may warrant the employment of deep or trench ploughing.

Fortunately good farmers have always turned a deaf ear to such teaching, knowing that the depth of the furrow must be regulated by circumstances. That deep cultivation is right as a principle no one denies, but experienced cultivators regulate the depth of the furrow as above explained. Deep ploughing, i.e. over 9 inches or more, is advisable for certain objects. It may be recommended for potatoes, mangel-wurzel, and other root crops; but corn crops, as a rule, and especially oats, do better after a shallower cultivation and on a firm bottom.

Perhaps no crop has been more discussed in this connexion than wheat, and yet a furrow of from 4 to 5 inches deep, or even shallower, has been found to yield satisfactory returns. On the other hand, there

have been cases in which single wheat plants have yielded extraordinary quantities of grain after deep cultivation. One system consists in forming a trench for the reception of the seed and mulching the deeply placed young plants with successive layers of soil as they grow upward, until the surface is reached. Such systems are not, however, adapted for extensive wheat-growing, and cases might be cited in opposition in which heavy crops have been produced after "breast ploughing", i.e. with a system of hand ploughing little deeper than hoeing. The truth is that wheat, barley, and oats are usually sown after comparatively shallow ploughing, although they really receive benefit from previous deep cultivation. In the course of a rotation of crops root and corn follow each other in orderly succession, and the deeper cultivation given for the roots reacts upon the succeeding corn crops.

Cereal crops appear to prefer a firm or solid substratum underlying a finely worked and loose top. The ground is well trodden with horses and the passage of implements; the "land-presser" is a most valuable implement for this purpose, and even sheep are driven over the field in order to secure consolidation. Loose land is never favourable for corn, and hence while deep ploughing is beneficial for root crops, and indirectly so for corn, it is not desirable immediately before cereal crops.

Gradual deepening of the soil is also in most cases better than a sudden increase in depth, and this is consistent with the practice of bringing up a little fresh soil to the surface every time a field comes round for roots, and giving the deeper ploughing in the autumn, so as to obtain the benefits of frost upon the newly brought-up soil.

The *width* of ploughing, although less important than the depth, is well worth attention. A wide furrow means a larger amount of work done in the day, but the pulverizing effect is diminished. The standard width is 9 inches, and this practically agrees with a depth of 6 inches. The limits as to width lie between 8 inches and 12 inches. There must be a due proportion between width and depth in order to lay the furrows at the proper angle ( $45^\circ$ ), especially in the case of lea ploughing. If the ploughing is too deep the furrow is left too upright and does not "pack" with the preceding or succeeding ones. If it is too shallow the work is flat, and will not catch the teeth of the harrows. In loose land ploughing takes the form of "stirring", rather than inverting the soil. The land is pushed rather than turned, and in such cases a 12 in. furrow is not too wide, and  $1\frac{1}{2}$  acres can easily be ploughed in the day. A narrow slice is more suitable for seed-beds, and a stud or short knife is fixed on the mound board to still further pulverize the furrow. Forms of furrow slices are shown in Fig. 16.

Double-furrow ploughs are a great improvement upon the old, and still commonly used single ploughs, as they carry very short land-sides and slades, and for this reason exert much less friction upon the bottom of the furrow. They are, however, sometimes troublesome to use when the land is frozen on the surface or covered with haulm.

Ploughing is both an initial and final operation, and is generally the first act of husbandry in breaking up a stubble or a prairie.

Harrowing with a view to causing charlock and other weeds to strike may precede it, but, so far as effective tillage is concerned, the plough holds its place. Steam cultivation may, and does often, supersede ploughing. It is so powerful that it rips up and smashes a stubble as effectively as any plough, perhaps more so; but this is not always realizable, as a great deal of land is too thin for steam cultivation. The tines penetrate too deeply, and bring up raw material as well as the seeds of weeds. Secondly, the inversion of the soil

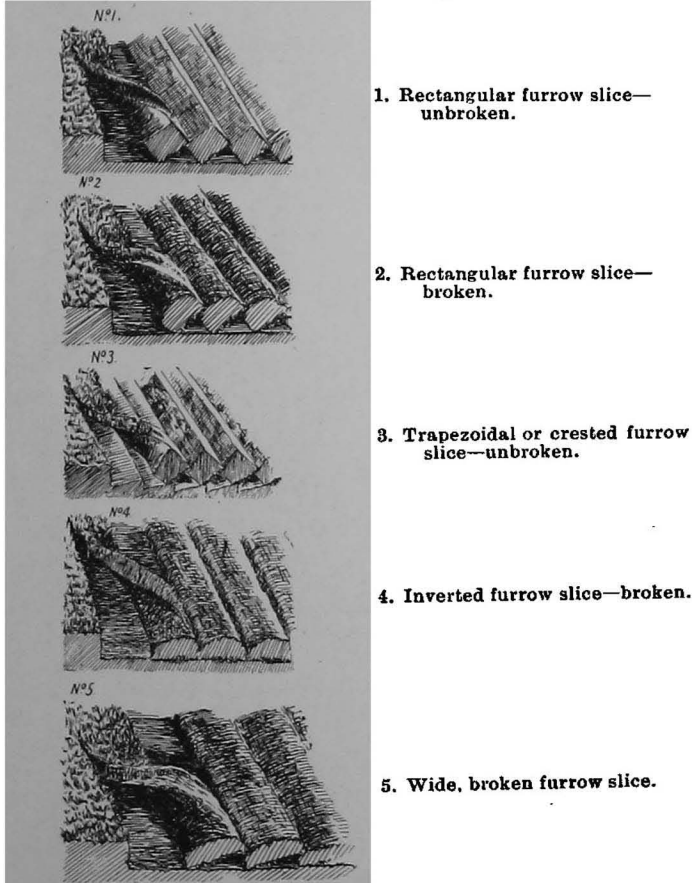

FIG. 16.—Types of Furrow slices.

is not so effectively performed by cultivators as by ploughs, and this is an important point. It is desirable that every part of the cultivated land should be exposed to the air and frost, and besides this the ploughshare severs all tap-rooted weeds, such as docks, thistles, scabious, knapweed, and coltsfoot. Horse cultivators are defective in this respect, as their tines are apt to slip past these tough roots.

The widths of ploughshares vary, and a broad-share increases the draught. A broad-share converts a plough into a "parer", better

adapted for skimming the surface than for deep work ; but, in all cases the wing should be wide enough to sever the slice completely and cut all roots. A share should be flat, and fixed horizontally, so as to ensure a flat horse-walk and a rectangular furrow slice, or the ploughing will not be sound. Tilted shares turn crested furrows, i.e. furrows in which the exposed angle is slightly acute. This gives a fine and sharp appearance to the work and may secure a prize in a ploughing match. It is also said to catch the teeth of the harrows better, and to provide a deeper seam for broad-casted corn. It, however, leaves an uneven horse-walk, and a portion of soil is left below which ought to have been brought to the surface.

As soon as the share and coulter have severed the furrow, the slice passes up the mould-board or "turn-furrow" until it arrives at a point (that of greatest draught), when it begins to fall over until finally it rests against the previous slice. There should be no squeezing, and in the most perfect mould-boards a lea-furrow is turned without a break or flaw. This of course is admirable, reflecting credit both on the plough and the ploughman. It is, however, open to objection where pulverization is the principal object, and hence the introduction of digging-breasts and short mould-boards which break the furrows and leave them exposed on both sides. On strong land, pulverization is often achieved by raising it into narrow ridges after it has been ploughed and dressed. These ridges exactly resemble those used in potato planting, and are about 27 inches from crest to crest. They become weathered and tender during the winter, and are harrowed and formed up again with a double-mould board plough, ready for sowing or planting in due course.

The plough and the horse cultivator were long rivals, but appear to have settled at length into an arrangement in which the plough is senior partner. The plough leads, and the cultivator follows ; the plough breaks fast ground, and the cultivator tills loose land. The plough is a radical, inverting or subverting the established order of the soil ; but the cultivator is a conservative, keeping the finest and richest soil on the surface, and preserving moisture in the interior. There are opportunities for both, but the plough opens the way before and during winter. The result is a mellow surface which it is the province of the cultivator to retain. Spring ploughing dissipates moisture, and brings too much raw material to the top, and undoes what the winter has effected. To repeatedly plough in spring is therefore injurious. The "cultivator" effectually destroys surface weeds, and draws out the long strings of couch-grass without breaking them into short lengths. It buries nothing, but leaves the dried rack on the surface ready for picking off.

The harrow and roller are subsidiary, and more superficial. They act entirely on the surface soil, reducing clods, and detaching the soil from the roots of weeds. Thus the four tillage implements co-operate in producing a deep, clean, and moist seed-bed, which is the goal of all successful tillage ; and although their outward forms have altered, they still remain substantially as they were in Anglo-Saxon times.

The Future of Tillage.—Many efforts have been made to displace the old tillage implements, among which a more extended use of the

spade has been advocated. The spade boasts a still higher antiquity than the plough, and is, if anything, more effective; and it early occurred to inventors to substitute digging for ploughing. The object was to accomplish by one operation all that was done by the combined action of ploughs, cultivators, harrows, and rollers. The idea was excellent, and still lives in the minds of many inventors. In some cases it may prove successful, but one important point appears to have

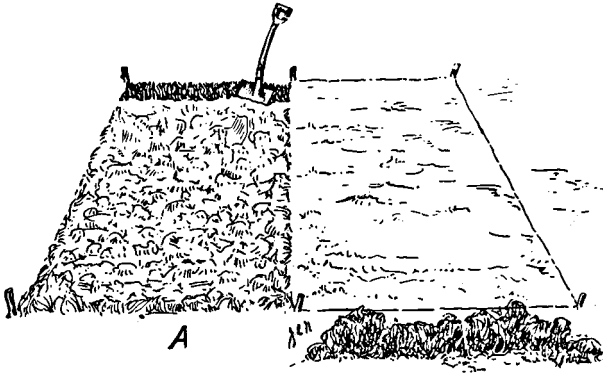

A. Trenching showing the soil removed at the commencement ready to occupy the space remaining at the end of the plot.

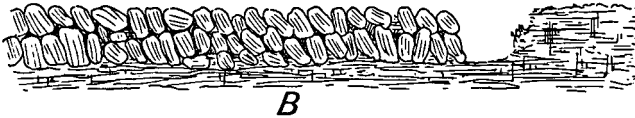

B. Soil left rough after double-digging to "weather" throughout the winter.



FIG. 17.—C. Same soil in the spring showing the effects of weathering.

been forgotten, namely, that the co-operation of the weather is necessary in the formation of a tilth.

All successful cultivators endeavour to time their operations so as to secure this co-operation, and failure is often due to neglecting this condition. Land must be allowed time to "make" or mellow down. Rain must fall and winds blow, the sun must shine, and frosts must assist, before a perfect tilth can be produced. (Fig. 17), and these

unpatented tillage implements are neglected by those who hope to make a fine tilth in a moment.

Particles of clay are liable to run together again, and to once more form a plastic mass when they are too rapidly reduced to a fine state of division. This is a difficulty well known to farmers and takes the form of a scrap or layer of dry puddled soil after heavy rain has fallen upon a newly-made seed-bed. When, however, clods have been reduced by natural forces the particles show no such tendency, but appear to be repellent rather than attractive to each other. Hence winter ploughing and exposure is properly followed by spring cultivation, harrowing and rolling.

There are other still more novel ideas on the *tapis*, among which is the use of explosives by which pulverization is to be effected by detonation. This new development may be of practical use in certain circumstances which may lead to further extension. It may, for example, be found possible to develop disruptive forces within the soil of less violence than explosives, by which gases are evolved which both destroy noxious insects, and separate or heave up the soil. We already know that organic matter puffs up the soil during its decay, and this action might be increased and intensified. We must not therefore shut our eyes to further possibilities in tillage.

Another direction in which further development may take place is greater attention to root action. Whatever may be said upon the possibilities of explosives or detonating action on refractory subsoils, there is no doubt that a similar but more gradual effect is produced by the roots of plants. In discussing the origin of soils it was shown that root action has always been a force, and recent investigations made under the auspices of the Royal Agricultural Society have demonstrated its importance, notably as a means of ridding land of wild garlic. One of the side effects of nitrate of soda is to encourage root action; and for many years cylinders of soil enclosed in glass were to be seen in the Laboratory at Rothamsted, showing the action of roots in deepening the subsoil and effecting its pulverization. Such methods as these are more within the powers of agriculturists than the use of detonators. They, however, require time as well as study, but, as regards the deepening of the staple, they are well worth consideration. Deep-searching plants, such as lucerne, penetrate the subsoil many inches below the plough sole, and the continuous growth of such crops cannot fail to be beneficial. It is of great importance that the means used should be cheap as well as effective, and a system of improving land by growing crops suitable for this object would be truly economical, especially if the crops were profitable in themselves as well as beneficial to the soil. Mr. Elliott of Clifton Park, Kelso, makes use of deep-rooted plants for the formation of temporary pastures, and has found that the strong and deep-searching roots of chicory and burnet have broken up the hard "pan" existing in some of the soils, and "helped in the tillage of the land".

Roots are acknowledged to be important enrichers of the soil, and what are called root crops are especially so. Every farmer recognizes the value of the clover root as a preparation for wheat, and the accumulation of organic matter in pasture lands is accounted for by

the development of roots below the surface. In looking at the various possible methods for improving land, none seem more hopeful than that of using vegetation itself as a tillage agency.

**Dry Farming.**—This system has been recommended and practised of late years on the Dry Belt of America and elsewhere, and is suitable for countries of deficient rainfall. It includes other features besides that of special cultivation of the soil, as seeds and seeding, and the use of desiccated or dried seed, and a selection of suitable crops. It is used for wheat cultivation, and for sorghum, millet, spelt, wheat, rye, barley, oats, Kaffir corn, lucerne, and, in some cases, sugar beet. The resulting crops are not heavy, and in the case of wheat the average return is estimated at 15 bushels per acre. This is, however, thought satisfactory under the special conditions of climate which prevail. It is also maintained that wheat (and some other crops) can be grown consecutively upon the same land, under this system of cultivation.

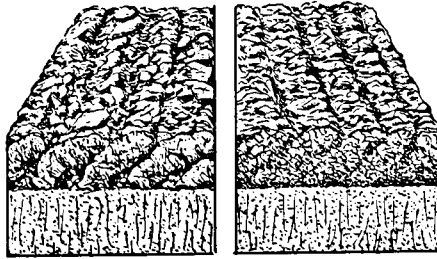

Undisc'd stubble ploughed.      Disc'd stubble ploughed.

FIG. 18.

As to the peculiarities of the system, it in several respects resembles good cultivation as carried out by enlightened farmers in Great Britain. It aims at pulverization, and the conservation of moisture, and in a special degree at the promotion of capillary action from the subsoil. Ploughing is not done deeply, and 8 inches is named as sufficient. Deeper work is advocated in many cases, and especially for deep soils. On such soils there is no reason why the ploughing should not be 1 foot deep, and an important point is that of employing the finely pulverized surface soil as a mulch, on the same principle as repeated horse hoeings are advocated in this country as the best protection against drought.

Viewed in this way dry farming is not a new discovery, but rather an adaptation of the best methods of cultivation to a climate in which the rainfall is deficient and uncertain. As an example of the methods pursued, the land is disc-harrowed before it is ploughed (Figs. 18 and 19), and the ploughing is performed in the autumn, before the rainy season sets in. Double discing *after* the removal of the crop and before



ploughing, produces a state of soil favourable for the retention of moisture. After ploughing, the land is pressed with a packer or fluted roller, which consolidates the lower section of the furrows and leaves the top loose; much in the same way as a land-presser acts upon a furrow previous to wheat-sowing. The harrow follows the packer, and all three operations should, if possible, be carried out on the same day. The mulch of fine surface soil thus obtained should be preserved by repeated harrowings, especially after rain, i.e. as soon as the surface is dry enough to work kindly, without puddling, or forming clods. Thus any disposition to form a scrap or skin of baked soil is avoided, and the land is kept in the best possible condition for retaining moisture.

Seeding may be done in autumn or in spring, and it is recommended to deposit the seed at least 1 inch into the moist bed, which may entail a total depth of 3 or 4 inches from the surface. Rolling and harrowing are again done after the braiding of the young plants, and these surface cultivations are repeated at intervals, so as to

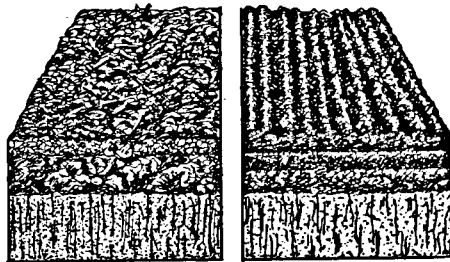

Stubble field ploughed and harrowed with peg-tooth harrows.

Disced stubble field disced and harrowed after ploughing.

FIG. 19.

keep the top soil loose, and upon this the success of the system largely depends. The quantity of seed sown is comparatively small, and half a bushel per acre is considered sufficient for wheat. It is even alleged that the dryer the climate the less seed is required, but this is a point upon which experience must be the best guide. The principles which underlie the practice of dry farming are therefore clear and rational. It is adapted for extensive cultivation where land is cheap, and the soil is deep and retentive. The principles are in themselves excellent, and might be put in practice on a small scale. They guide the gardener in the preparation of his seed-bed and in the after-cultivation of his crops; and in subsequent remarks upon root cultivation it will be found that stress is laid upon securing a mulch of fine soil, and keeping it loose and friable by constant surface tillages.

**Fallowing.**—The original idea which underlies fallowing was that land, like men and animals, requires rest. Land is certainly capable

of being exhausted or worn out, but replenishment is a better word. That a cistern may be exhausted is true enough, but that it is in any sense tired is rank nonsense. Exhausted land bears more resemblance to an empty barrel or an empty purse than to a fatigued animal or man, and hence we throw aside the idea of rest. Restoration is effected by manuring, and as long as land is liberally treated it will continue to produce crops.

It was held by the older chemists that certain plants exuded injurious excrementitious matter which poisoned the land for other plants, and upon this idea the benefit of rotations was supposed to be based. This, if it were true, would strangely support the idea of fatigue, for we are now assured that muscular fatigue is due to the accumulation of toxic principles in the blood, which clog the system and produce a sense of incapacity and weariness that can only be dissipated by rest. It does not, however, appear that such toxic or poisonous principles accumulate in the soil, and the idea of plant excrements is now abandoned, chiefly because no traces of them can be found. The soil is, however, so complex in its nature that there may be parallels, or analogous conditions induced by constant cropping comparable to fatigue in animals. If fatigue is to be accounted for on physical grounds, such as accumulation of effete matter in the blood; if infection is due to want of proportion between attacking germs and fighting phagocysts, it is not inconceivable that soil exhaustion may be produced by something else than want of plant food. The wonderful facts recently established with regard to antagonistic bacteria, protozoa, phagocysts, amœba, algæ, moulds, etc., all indicate the presence of a subterraneous flora and fauna which produce all kinds of intermediate compounds within the soil, and affect its "complex particle". Viewed from the new point of view, who can say what may be the cause of barrenness and unproductiveness in certain cases? The bare statement that soils are exhausted merely because they have not been sufficiently manured may be inadequate in the face of such a crowd of new facts.

It is also being more and more recognized that plant diseases are due in certain cases to a want of some material which has been regarded as unimportant, or as only occurring in quantities so small as to be neglected in analysis. Plants are, however, known to contain traces of a number of rare metals and non-metals, not included in ordinary analyses, and no one knows how far their presence or absence may be the cause of barrenness or even of exhaustion. These questions are all awaiting the student of soils, and he is bold who in the present condition of our knowledge will dare to say why it is that one square foot of soil produces a vigorous plant, and the next square foot a puny one which will never arrive at maturity.

**Why Root Crops renovate Land.**—Experience shows that land requires to be fallowed periodically, but not necessarily rested. It is a curious fact that the crops specially selected as an alternative to bare-fallowing are of the most exhaustive nature. Land which is now carrying an unconsumed crop of swedes is at its lowest point of fertility. It has gone through its prescribed rotation, and yielded crops of barley, hay, and wheat. It then comes into swedes, which, if

successful. make greater demands upon it than any of the preceding crops. Why, then, is this last crop considered to be a substitute for the old-fashioned resting period, known as bare-fallowing?

The answer is not difficult, nor unexpected. Root land is necessarily tilled and exposed to the influence of the atmosphere for months previous to the sowing of the seed. It is liberally manured, and superphosphate is drilled with the seed. The crop is also destined to be consumed on the field or the holding, so there is no final removal of fertilizing matter as in the case of wheat, barley, and oats. The consequence is that the field is renovated and ready to go through another course of exhausted cropping; but, at the same time, it never is more exhausted than during the time it is producing this particular crop of swedes, except of course for the manure it receives. Sir John Lawes himself remarked that no system of cultivation more quickly exhausts a field than growing and *removing* successive crops of swedes or other root crops.

The reasons why an exhausting crop of roots, following other exhausting crops, restores the fertility of land may be briefly stated as follows:—

- (1) Cultivation promotes the pulverization of the land.
- (2) Root crops are sown late, and therefore facilitate cleaning.
- (3) They are, or should be, liberally treated.
- (4) They are subjected to hoeing and interculture.
- (5) They are consumed on the holding.
- (6) They are eaten with fodder and concentrated foods, which are also fertilizers.

The amount of cake or corn eaten on an acre of good swedes is very large, and may be expressed approximately at 1 lb. per sheep per day, for one week for, say, 350 head, i.e. 2,450 lb. or upwards of 1 ton per acre, costing from £7 to £10. To this must be added the manurial residues of the roots, hay, straw, and other fodder consumed, the farm-yard manure applied to the land, and the superphosphate drilled with the seed, and the above question is satisfactorily answered.

Root crops take the place of bare-fallows on most classes of land, because they fulfil many of the same objects. They enable the land to be thoroughly tilled up to the period of sowing, and, in fact, throughout their growth. They encourage liberal manuring, because they cannot be successfully cultivated without it; they restore all they receive to the land, and leave it in a good mechanical condition.

Fertilizers: Exhaustion of the Soil.—Reference to the ultimate composition of the soil shows that, even when it is fertile, the percentage of *available* plant food may be expressed in the third place of decimals, i.e. in hundredths of thousandths. Thus 1 per cent equals  $\frac{1}{100}$  and .1 per cent equals  $\frac{1}{1000}$ , and .004 or .008 per cent is equal to  $\frac{4}{10000}$  or  $\frac{8}{10000}$ . These figures, when applied to the total amounts of available phosphoric acid or of potash in the soil, are seen to be very small, and have already been shown to represent from 120 to 240 lb. severally in each case, out of a total of 3,000,000 lb. A rough calculation was also made as to the amounts of mineral matter and

nitrogen removed by certain commonly grown plants, from which it appears that a few crops sold off the land would soon reduce it to poverty.

It is needless, and might be misleading, to calculate how many crops of wheat would exhaust a soil of all its available phosphoric acid, or how many crops of mangel-wurzel would be required to use up all the available nitrogen, and that for the following reasons. First, as the quantity of these important constituents is reduced, the crops themselves would diminish, and this alone would prolong the period in which poor crops might be produced. Secondly, there must be a gradual passing over of materials soluble in strong acid to a condition soluble in weak acids, or in water impregnated with carbon dioxide, so that the soil would slowly replenish itself as time went on. Thirdly, there is a reservoir of refractory mineral matter which in course of time may be reduced to a soluble condition. There are

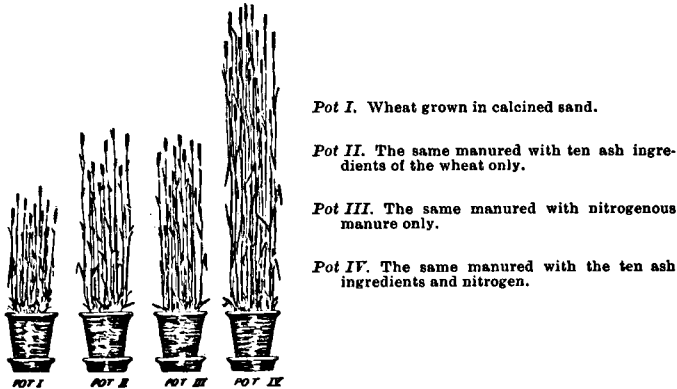

FIG. 20.—Ville's Experiments.

therefore differences in degrees of exhaustion, which may be expressed as immediate, protracted, and ultimate.

When a field is too poor to produce more than a couple of corn crops in succession, it may still be regarded as in a fairly normal condition. The stock of available plant food is not exhausted, but the root system of the plant finds it difficult to secure a sufficient quantity for vigorous growth, and the soil is therefore said to be worn out. This view also shows the importance of comparatively small dressings of soluble salts, which bear a very low ratio to the amounts contained in the soil, and accounts for the marked effect produced by small quantities, such as  $1\frac{1}{2}$  cwt. of nitrate of soda or 3 cwt. of superphosphates. While such dressings bear a very small proportion to the soil contents of the same fertilizing substances, they represent a large and probably a full necessary amount for the requirements of a single crop.

In good farming these materials are applied at regular intervals and in recognized quantities, suitable for each crop without need of elaborate calculations; and these quantities are increased or reduced, not so much on chemical grounds, as by observing the results obtained. In the economy of a farm these substances first act on the crops to which they are applied, and then react upon the succeeding crop through the intervention of live stock, which consumes the produce, and leave behind them manurial residues of great value.

The result is that fertilizing matter first exists in, or is added to, the soil. The crop lifts it above the surface, and after consumption by live stock it is again buried by the plough, so that the fertilizing elements are alternately raised above and sent below ground, and a circulation is established which keeps up fertility. Even this tends to exhaustion, on account of a constant drain from the sale of grain, straw, milk, wool, and live stock. There is, however, a powerful

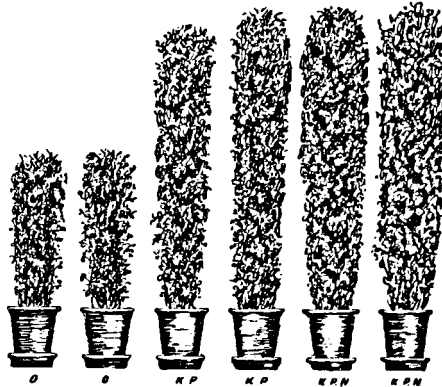

FIG. 21.—Effect of nitrogenous manure on peas. O. no manure; K.P. potash and phosphoric acid; K.P.N. potash, phosphoric acid, and nitrogen.

compensating effect when foods are purchased and fed with the natural produce of the land; and so effective is this system of manuring, and of consuming foods purchased, that all anxiety as to exhaustion is obviated. Not only so, but a farm so managed will increase in fertility, and improve in value. Thus the question appears to be solved by the practice of good farmers, and to a great extent it is so.

Complications.—There are, however, many considerations which show the importance of a knowledge of fertilizers. There is, for example, the great differences in soils, which at once suggests different systems of both manuring and cropping. Retentive soils are able to retain fertilizing matter for several years, while light soils run down in a single season. There is also the question of washing through into inaccessible substrata, which indicates a hungry soil requiring its fertilizers, just as a delicate individual requires his food, little at a time and often. It is also found that there is a point at which

supplies of fertilizing matter become excessive and therefore wasteful ; and a further point, in which heavy dressings of farm-yard manure are actually injurious by the denitrifying of nitrogenous matter, and by promoting the disengagement of free nitrogen gas.

Again, different crops require different kinds of plant food (Figs. 20-2), and it is important that a farmer should know what manure to apply in each case—a matter in which much ignorance is often shown even by good practical men.

**Too much Reliance on Yard Manure.**— It has been urged that “plenty of muck” solves the entire question of manuring, but recent investigations have fully proved that this is a mistake, or at least a half-truth. The denitrifying effects of organic matter in excessive quantities now rests on high authority, and is as exhausting as cropping itself, if not more so ; and on this point reference to Dr. Russell’s valuable work on soil conditions and plant growth may assist the reader to detect a weak point even in farm-yard manure. The first fact which bears directly on the loss of organic nitrogen is the rapid reduction of nitrogen in broken-up prairies

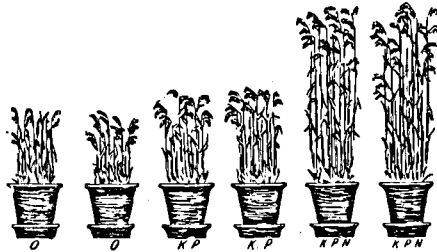

FIG. 22.—Effect of nitrogenous manure on oats. O, no manure ; K.P, potash and phosphoric acid ; K.P.N, potash, phosphoric acid, and nitrogen.

recorded by F. T. Shult in the *Journal of Agricultural Science*, 1910. The effect of cultivation during a period of twenty-two years was a loss of 2,190 lb. of nitrogen per acre, of which only 700 lb. was accounted for by the requirements of the crops, leaving a dead loss of nitrogen of 1,490 lb., or 68 lb. per annum ! The conclusion arrived at is that “the exhaustion of the soil is therefore not due to the removal of the crop, but to the cultivation”.

That there is a remarkable loss of nitrogen from arable land (for it does not take place in unbroken pastures) is clearly shown by the following figures : “One of the Broadbalk (Rothamsted) wheat plots receives annually 14 tons of farm-yard manure per acre, containing 200 lb. of nitrogen. Only little loss from drainage can be detected, and there is no reason to suppose that any considerable leakage of nitrates occurs ; but the loss of nitrogen is enormous, amounting to nearly 70 per cent of the added quantity. Alongside is a plot receiving no farm-yard manure, from which also the loss from drainage is very small.”

Comparing these two plots with each other some exceedingly striking figures are obtained, based on the original amount of nitrogen in the soil in 1865 (4,340 lb.) *plus* the nitrogen annually added in the manure (200 lb. per acre); rain (5 lb.) and seed (2 lb.). These amounts of nitrogen added together amount from 1865 to 1912 to 9,730 lb. per acre, which has to be accounted for as far as possible. The total amount of nitrogen originally in the soil, and the added nitrogen, was during the entire period 14,070 lb., and the question is how much of this remained as nitrates and other forms of combined nitrogen in 1912? The first point of importance is that there was an actual and considerable gain of nitrogen during the entire period represented by a rise from .175 per cent in 1865 to .245 per cent in 1912. This increase is, however, very far short of the expected gain. The nitrogen removed by crops during this period was estimated at 2,550 lb., but the actual disappearance of nitrogen was 8,340 lb., showing an annual *dead loss* of 123 lb. of nitrogen. The explanation is best given in Dr. Russell's own words: "Experiments of that kind have led to the conclusion that some gaseous product is formed in addition to nitrates, and, as no sufficient amount of ammonia can be detected, it is supposed that gaseous nitrogen is given off. The conditions for this decomposition appear to be copious aeration, such as is produced by cultivation, and the presence of large quantities of easily decomposed organic matter. Now these are precisely the conditions of intense farming in old countries and of pioneer farming in new countries, and the conclusion is that the reserves of soil and manurial nitrogen are everywhere being depleted at an appalling rate. Fortunately there are recuperative influences, but one of the most pressing problems at the present time is to learn how to suppress this gaseous decomposition, and to direct the process wholly into the nitrate channel."

It may be pointed out that both prairie lands and the plots in Broadbalk field differ materially from ordinary cultivated land. In the first case the cultivation is exhaustive and often unchecked by systematic rotations and periodic manuring. In the other it illustrates a system of continuous wheat-growing and exceptional amounts of organic matter added to the soil. In both cases a loss of gaseous nitrogen is evidently favoured by special circumstances.

Everyone now recognizes the importance of leguminous crops in arresting this loss by the formation of combined nitrogen through bacterial action, now so generally appreciated.

The four-course rotation is a wonderful arrangement for preserving nitrogen in the soil. It is not confined to taking clover, or any other crop, once in four years, but extends to beans, peas, vetches, lupins, and all the other leguminous crops. It probably will be found not to be entirely confined even to them, as cruciferous plants, such as mustard and turnips or swedes, undoubtedly contain albuminoid matter, which directly or indirectly must be derived from the atmosphere. Thus, while there is a disengagement of combined nitrogen, there are combinations of free nitrogen, which bear upon the question of the exhaustion of this vital constituent.

There is, however, an evident danger in heavy and frequent doses of farm-yard manure which have been, and are, applied to land, especially in market gardens. A rational system of manuring seems to consist in more moderate dressings of farm-yard manure, applied to the crops which most immediately benefit from their use. Encouragement is also given by this view to the use of nitrates, free from masses of organic matter in a state of active decay ; and also of phosphates, potash, and lime salts, which promote the growth of clover and other leguminous crops.





## CHAPTER IV.

### GENERAL MANURES.

FARM-YARD manure may be described as the remains of vegetable matter, whether it is composed of litter or of food residues. It is usually a mixture of animal excrements with straw, in varying proportions. It is also often enriched by the consumption of purchased foods, but in any case it contains nitrogen, and all the mineral salts found in the ashes of plants.

It is therefore a complete or general manure, containing every ingredient which plants remove from the soil in similar proportions to that in which they were selected by roots. The excrementitious part is, moreover, in an extremely fine state of division, and therefore when liberated by decomposition is soonest appropriated by growing plants. It is in a sense a sort of protoplasm. It is difficult to mention any other manure which so completely restores everything taken out of the soil by plants, although rich composts may be looked upon as strong rivals.

The dead bodies of animals, or blood, certainly yield analogous analyses; and guano approaches it in composition. None of these substances are, however, equal to it either in general distribution or availability, and none of them contain the constituents of plant food in such well-balanced proportions. Well-made and enriched farm-yard manure stands alone as the typical restorer of fertilizing matter to the soil, and may be compared to milk, which is the unrivalled food of animals. The parallel between milk and farm-yard manure is in fact very striking, for both contain what is wanted, and both are derived from previously existing animal or vegetable tissues.

Enriched manure, i.e. fortified by cereal and oleaginous seeds (meal and cake), contains the constituents of straw and corn, roots and leaves, and is therefore perfect for its purpose. If it fails, it is through the abstraction of materials which are removed as saleable products; but this can be counterbalanced by increasing the amount. It has been argued that farm-yard manure used alone must exhaust the soil in the end, because of the above constant abstraction; but this only applies when there is no enrichment by means of purchased foods, and although it is a valid argument in the abstract, it is not so when applied to the case of farms managed on a liberal principle.

Where farm-yard manure does actually fail is in quantity, for no farm can produce more of it than to dress a small proportion of its total extent. Various estimates have been made as to the quantity of yard manure which can be produced on a well-managed farm, and

the basis usually employed is the average weight of straw, multiplied by the amount of water and other additions necessary for converting it into manure. If dry straw be multiplied by 4 we get a tolerably accurate measure of the total weight of fresh manure produced, but this does not provide for the diminution of weight due to partial decomposition. As, however, it is now the practice to apply freshly made manure in preference to rotted dung, this does not count for much, and there are other minor sources of refuse which ought to be added to the straw, such as haulm, hay residues, parings, scrapings, etc., which find their way into the manure heap.

In the case of 400 acres of arable land producing 200 acres of straw, the maximum production of farm-yard manure cannot be much more than 800 tons per annum, which means 2 tons per acre over the entire farm, a quantity which is evidently insufficient. It also means a dressing of 8 tons per acre every four years, which would scarcely satisfy a good farmer's ideas as to liberal management.

The consequence is that yard manure is bestowed upon certain crops, and especially upon root crops and wheat. Actually there is not more produced than will allow of a dressing of 16 tons per acre to half the root land on the four-course system; or, if half of it is devoted to the wheat land, only 8 tons per acre would be left for half the root land. It is this which compels farmers to use "artificial", quite irrespective of their opinion as to their comparative merits.

That the yard manure ought to be spread over a wide area is therefore clear, and as regards denitrification, in practice, and with the limited amount available, there seems little danger of the accumulation of such quantities of decomposing organic matter in soils as, for example, in the Broadbalk field at Rothamsted. Farming practice at its best, often throws as much light upon agricultural chemistry as chemistry does upon practice, and we can scarcely believe that farmers are wrong in their high estimation of the value of farm-yard manure.

They have not enough of it to err on the side of excess, although in some cases market gardeners may do so. The application of big dressings of 30 and 40 loads to the acre is doubtful policy, and might be better distributed. Few farmers, however, exceed 20 one-horse loads to the acre, and there is an increasing disposition towards dressings of 12 loads, or tons, per acre, at intervals of two to four years.

**The Weakest Constituent in Farm-yard Manure.**—The weakest element in farm-yard manure is phosphoric acid, but this is compensated for by the extended use of superphosphates. There is an excess of potash, a large amount of nitrogen, and a great deal of carbonaceous matter and water.

Among other valuable properties of farm-yard manure is its durability, due to its organic nature. It is composed of organic matter in three conditions—

1. Watery solution.
2. Finely divided excrementitious matter.
3. Fibre, or the constituents of litter.

Its immediate action is due to the liquid manure contained in the wet mass. Later effects are due to the finely divided matter which has passed through the alimentary canal of cattle; and the long-continued action, extending over extremely long periods, and in fact practically without limit, is the result of the slow decay of the litter.

The gradual liberation of nitrogen, as nitrates, is an especial attribute of farm-yard manure. Nitrates are easily washed through the soil, and this is one of the weak points of nitrate of soda. The decay of the litter in farm-yard manure proceeds slowly in winter, and more rapidly in warm and moist weather, when growth is most luxuriant; and the consequence is a liberation of nitrogen, and the formation of nitrates when they are most required. The same climatic conditions stimulate the nitrifying bacteria, so that the arrangement is well balanced, and almost suggests a self-regulating power.

**Analytical Composition of Farm-yard Manure.**—Enough has been said to indicate the general composition of farm-yard manure, and if any reader wishes for more precise information on the subject there are complete analyses in most textbooks and cyclopædias of agriculture. There seems, however, little object in reproducing them here, as the composition is, qualitatively, simply a repetition of the constituents of the tissues and ashes of plants, and a reflection of the contents of a fertile soil. The composition is also exceedingly varied as to percentages, as there is much difference between enriched manure, produced under cover, and strawy stuff made in exposed situations. Well-rotted manure yields a better analytical result than unrotted manure, but while this is true there is much actual waste in the process of decay. The percentage of nitrogen may be higher, as also of phosphoric acid, and all fixed material; but this is due to the enormous loss of carbonaceous matter, unfortunately accompanied by a loss of nitrogen. The organic matter is dispersed as carbon dioxide and watery vapour (products of combustion), while the organic nitrogen in the food residues and vegetable tissues is converted, first into ammonia, next into nitrites, and then into nitrates. Unfortunately the change does not stop here, for in the presence of an excess of carbonaceous matter the nitrates are further acted upon by denitrifying bacteria and escape as free nitrogen gas.

Although well-decomposed manure is weight for weight superior to freshly made manure, the total original weight is diminished in many cases by one-half, and the analytical improvement cannot compensate for this loss. While therefore a ton of well-rotted manure is worth more to purchase than a ton of freshly made stable or town manure, it by no means follows that it pays a farmer to rot the manure produced on his own holding. If the total manurial content of the straw, roots, hay, purchased foods, etc., are not to be allowed to escape into the air, the manure should be carted straight from the yard on to the land, and ploughed in.

*Bulk* is in reality a valuable quality, as it is decomposed *within the soil* instead of being exhaled into the air, and acts physically upon the soil particles. On clay lands, especially, it lightens the

texture and facilitates drainage, as is well known to farmers. Well-rotted manure is undoubtedly beneficial for light soils which need consolidating, and for certain crops which require to be supplied with immediate nourishment; and this suggests its purchase whenever possible, especially as, at a moderate price per ton, well-rotted dung is always cheaper than fresh stable litter.

**Leaving Farm-yard Manure on the Surface.**—The custom of leaving manure spread over the surface of land for many weeks before ploughing it in is defended on the ground that only carbon and moisture are lost, and that they are no manurial value. How far nitrogen escapes is not known, but some of the ammonia undoubtedly does. The escape of ammonia in manure heaps is probably arrested by the formation of salts of ulmic, crenic, and other humic acids, in which ammonium forms the base; but all such questions are as yet *sub judice*, as they now appear more complicated than in the early days of Agricultural Chemistry.

**Manuring Young Clover.**—The practice of manuring young clover in the spring, instead of reserving the dressing until autumn, is quite common. Here we have not only to consider the indirect action of the manure on wheat but also its direct action on the clover. By increasing the crop of clover the farm-yard manure stimulates the production of clover root, and with it the nodules or warty excrescences which contain bacteria capable of fixing the free nitrogen of the air. This symbiosis is a matter which has assumed vast importance during the last twenty years. It may account for the benefit of applying farm-yard manure to young seeds quite apart from the question of loss of nitrogen in the exposed manure. It may in fact justify practice, as so often is the case, but it certainly introduces a new factor into the problem.

**Apportionment of Farm-yard Manure.**—The limited amount of yard manure renders its distribution very important. As a rule most of the manure finds its way on to the arable land. Grass lands are generally starved in this respect, but it by no means follows that they are neglected. They receive a good deal of the food residues voided by cows and grazing cattle, and the loss of phosphates is made up by dressings of basic cinder and superphosphate. The question of apportionment of yard manure chiefly affects arable land, and a few remarks will assist the reader in seeing clearly to what sections it should be applied.

In the first place there are years in which manure does not appear necessary, as for example after a root crop fed upon the land by sheep, or after green crops similarly disposed of, or, possibly, after beans or clover which leave the land rich in nitrogen. Again, some crops are more independent than others, and thrive on comparatively poor land. Thus oats, although greedy feeders, are less exacting than wheat, and barley, although developing heavier yields of corn and straw when manured, sometimes suffers in quality from over-manuring. If the four-course rotation is taken as a type, it is evident that the land is in the greatest state of depletion after the removal of the wheat which ends it; and a large share of the farm-yard manure is properly devoted to the roots, which are best viewed as

beginning a new rotation. The second crop (barley or oats) needs no farm-yard manure, if the roots have been eaten on the land ; and clover may follow the spring corn, without it. The consequence is that the bulk of the yard manure is divided between the roots and the wheat, with the result that there is not enough for both. It is therefore necessary to subdivide, and the most practical course is to use the farm-yard manure for the root crops which are to be removed from the land, among which potatoes must rank, and the portion of wheat land which seems most to require help.

Mangel-wurzel stands out prominently as a deserving object for liberal manuring. It is capable of producing a heavy tonnage per acre, and is almost always carted off the field, and is therefore an exhausting crop. The same is true of swedes stored in heaps for fattening cattle, but not of swedes and turnips consumed on the land. These latter may be grown with the help of superphosphates and other artificial manures ; and the droppings of the sheep may be considered to be an equivalent for farm-yard manure. It will also be found that many root crops are grown near the homestead in order to save haulage, and this affects the carting out of manure as much as the carting home of roots. On the other hand, the root crops on distant fields are more economically fed on the land, so that labour is saved in both cases, and the fertility of the land is maintained as efficiently by the one system as the other.

**Other General Manures.**—General manures are, as a rule, waste products, as distinguished from manufactured articles. Their impurities are often recommendations, and decomposition is essential to their success. Farm-yard manure is the typical general manure, but rich soil almost ranks with it. "Dirt" of all kinds is promising as a fertilizing agent, and most refuses possess a value for the land. Farm-yard manure is itself a refuse or waste material, and it is no matter of wonder that other refuses should also possess fertilizing properties. They also are composed of used-up animal and vegetable tissues, and contain all the ingredients removed by plants or appropriated by animals. Thus the list is very extensive, and includes animal, vegetable, and mineral wastes, as well as mixtures of all three.

*Composts* may be described as rubbish-heaps. They are formed of refuse of all kinds, but are classed as animal composts and vegetable composts. They often consist of weeds raked off the arable land ; of rape roots and cabbage stumps, hedge trimmings and box clippings, garden refuse, potato haulm, road scrapings and pond cleanings, dead animals, and filth of all kinds.

They represent an extraordinary collection of debris, mingled with earth to keep the mass from being offensive. At a convenient time lime is added, and the whole mass is then turned, each spadeful being sprinkled with lime, and the result is a compost heap.

These heaps might be used to point a moral, for they are a remarkable instance of the value of waste material, and a good example of thrift. The amount of material available on a large farm is almost limitless. Road parings and ditch scourings are rich in organic matter, which only needs to be mixed with quicklime to

decompose it. Such heaps are sometimes many yards in length, containing hundreds of cubic yards of loose mould, which is of great value for grass land, or for deepening soil on bare brows of arable fields.

The treatment consists in placing lime beside the heaps and mixing it, when slaked, with the rubbish, and squaring up the heap. It is then left for months, and turned, screened, and formed up once more. All seeds and roots are then dead, and the resulting mould is really extremely rich, and might be used for garden beds or for potting.

Composts may also be made of refuse from slaughterhouses, fisheries, or glue-works, and even of the remains of horses slaughtered for their hides and oil. These composts are not mixed with lime but with earth, and yield a very rich mould. The well-known process of extracting nitrate of potash from nitre beds, discovered a century ago, is an illustration of the changes which take place in a compost heap. It is known as nitrification, and may be the explanation of the formation of nitrate of soda from seaweed or guano in past ages. Composting is destined to play an important part in intensive cultivation, for by it soils may be blended as well as enriched. They might form a basis for artificial soils, adapted for the requirements of exotic plants, and could be easily provided with an artificial subsoil to facilitate drainage.

Composting is almost the reverse of burning ; for in that process the organic matter is destroyed, and the ashes are alone preserved. Ashes may be regarded as a general mineral manure, but are wanting in nitrogen and organic matter. The practice of making composts is probably less general than it was fifty years ago, when portable artificial manures were comparatively unknown and more expensive than they are now. Good farmers prefer ashes to composts because they are less expensive and more rapidly prepared, but composting should not be forgotten, and in connexion with intensive cultivation it has a future before it.

**Seaweed as Manure.**—There is a similarity between farm-yard manure and seaweed, as both are of vegetable origin and contain all the ingredients of plant tissues. The sea is the receptacle of all the mud which is carried to it by the river systems of the world, and holds in solution all the salts required by plants, as well as that most characteristic constituent, common salt. Seaweed is also rooted on rocks, and to some degree extracts mineral matter from them. It is torn from its position during storms, and accumulates in vast quantities on the beach, whence it is carted to adjoining lands. Where this occurs the supply is perennial and exhaustless, and land which abuts upon the beach commands a higher rent in consequence. On the west coast of Ireland and the east coast of England it is much esteemed on account of its fertilizing effects, especially for young wheat. Owing to its cellular structure (in contradistinction to the fibrous character of straw) it decays very rapidly, and easily washes into the ground.

It is rich in nitrogen, as it contains about 13 per cent of albuminoids ; and in mineral matter, the greater part of which is

chloride of sodium. It, however, contains considerable amounts of potash, lime, magnesia, phosphoric acid, and sulphuric acid, and its mineral residue after burning is known as "kelp". The principal marine plants which are thus thrown upon the coast are various species of *Fucus*, one of which, *F. saccharinus*, contains as much as 12 per cent of mannite in its dry substance, and is used as food in the Shetland Islands and Hebrides, under the name of dulce.<sup>1</sup> There are also several other species, among which may be mentioned *Laminaria latifolia*, *Chondrus crispus*, *Iridæa edulus*, *Delesseria sanguinea*, etc. Seaweed or sea-wrack is considered to be equal or superior to farm-yard manure.

**Waste Products.**—All organic matter ; every combustible material which leaves an ash ; everything which decomposes—possesses fertilizing value. The soil promotes decay, and is the proper receptacle for all dead and effete matter. It abounds in micro-organisms which greatly intensify the action of "worms", the classic word used to express the devouring element in soils. The more highly organized the substance, the more rapidly does it decay, and the more valuable is it as a fertilizer ; thus blood, which contains everything necessary to nourish the body, is a valuable manure. When dried it contains all the constituents of the ash of plants—from lime, which is required for the building up of bone, to iron which gives to it its characteristic colour. Animal tissues are as potent as animal excrements, and hence slaughterhouse refuse is a rich manure. Similarly, anything which makes blood, i.e. anything which nourishes the animal body, is a manure, and this includes not only green fodder, roots, and hay, but cakes, which indeed are richer in fertilizing matter than the seeds from which they were derived.

In treating of waste products the first thing which must strike the inquirer is their enormous variety, and their complex character. They are, however, of very different values, first on account of the comparative speed at which they decay, and secondly because they differ in composition. Paper and linen rags, for example, have some value, because they yield an ash ; but are extremely slow in rotting away, and do not contain nitrogen. Bark from the tan-pits is another slowly decaying material which has a certain manurial value, but is undoubtedly slow in its action.

It is impossible to construct a list of waste products because of their great and increasing number, but it would include refuses from fisheries, glue-works, gasworks, woollen factories, saw-mills, flour-mills, breweries, streets, etc. The waste of fertilizing matter in sewage alone is appalling, and yet each of these products must be worth carriage, which is the test of their commercial value.

Carriage is a most important consideration, and is the great bar to using many waste materials which are of undoubted value. Sewage is one of the most striking examples of enormous aggregate value, coupled with insurmountable costs in application. "When we reflect," writes Professor A. M. Aikman, "that a ton of sewage, such

<sup>1</sup> A Scottish divine, in explaining the passages in the Book of Daniel relating to the pulse diet given to the selected children of Israel, is said to have brought the matter home to his congregation by saying, "Brethren, their pulse was our dulce"!



as is produced in many European cities, contains only 2 or 3 lb. of dry matter, and that the total amount of nitrogen in this is only an ounce or two, while the phosphoric acid is considerably less, and that it is on these two ingredients that its value depends, we see very strikingly how poor a manurial substance sewage is." And yet when used for irrigation, sewage produces the most wonderful results—much greater than ordinary water, for example; but the lesson is, that it can only be profitably employed when gravitation assists distribution. The disposal of sewage is, however, a matter of health, and the problem is not solely an agricultural one. It almost necessarily involves a pecuniary loss, which comes on the rates, and the agricultural produce of a sewage farm is looked upon as a mere set-off against charges.

**Interest in Waste Products.**—Agriculturists naturally feel a great interest in waste products; and manufacturers and municipalities are often strenuous in advocating the manurial value of their accumulations. All these wastes possess a certain fertilizing value, although many of them contain excessive quantities of carbon, sand, and foreign matter, which render it impossible to carry them any distance without incurring greater expense than they are worth. The stronger they smell, and the more repulsive their appearance, the more attractive do they appear, but these are not safe guides. All of them must be subjected to the arbitrament of analysis and the opinion of a competent agricultural chemist, and this frequently "pricks the bubble".

The authors of this small book disclaim all idea of writing a cyclopædia of Agriculture; and, to avoid disappointment, refer their readers to works where every manurial product capable of classification is discussed. Crosby Lockwood's *Complete Gardener*, 15th edition, Blackie's Standard *Cyclopædia of Modern Agriculture*, and Green and Sons' *Encyclopædia of Agriculture* are both modern and accessible to most students. Aikman's *Principles of Manuring* (William Blackwood and Sons, 1894) is a most useful work, and every textbook on agriculture contains this class of information. It has not therefore been thought advisable to fill these pages (limited as to number) with tables of analyses of innumerable waste products. A few may, however, be mentioned which are of general interest, and among them *soot*, because of its general distribution and double value, first as containing 3 per cent of nitrogen, and secondly as a protection against slugs and snails.

A ring of soot around seed in a garden is an impregnable fence, and a dressing of 40 or 50 bushels per acre is an economical dressing for corn or grass, if it can be bought at a reasonable rate. Sulphate of ammonia of 97 per cent purity may be worth £13 15s. per ton, and it is for the purchaser of soot on a large scale to compare the amount of this fertilizer with what he is buying, at say 6d. per bushel. Soot is a light material, and some calculation is necessary before a comparison can be made between 3 per cent by weight; and 25 per cent of ammonia, in a 97 per cent sample of sulphate of ammonia. The sulphate of ammonia, it will be noticed, only contains 25 per cent of actual ammonia, the remainder being sulphuric acid, so that

a 97 per cent purity means only 24 per cent of pure ammonia or 19·7 per cent of nitrogen. Nitrate of soda of 95 per cent purity contains 15·5 per cent of nitrogen.

Gas-lime is another popular application to land. Like soot it is offensive to slugs and insects, and this is its chief recommendation. It contains about ·25 per cent of calcium cyanide, which is poisonous to plants, but when thoroughly oxidized becomes a useful manure. It only contains traces of ammonia, but in some cases as much as ·25 per cent. It is found to be beneficial to pastures affected with moss, and in other respects it is about equal to lime. It is an error to look upon gas-lime as a powerful manure.

**Green-crop Manuring.**—There is but little difference in composition between turnips and the resultant excrementitious matter after their consumption by live stock. What difference there is, is in favour of the uneaten crop, for the animal system makes demands upon the food as it passes through the intestines. The conclusion must therefore be that a root crop ploughed in is a richer fertilizer than the same crop passed through the bodies of sheep or cattle.

The question is complicated when these crops are supplemented by other foods, some of high residual value; and hence a crop of turnips fed on the land is more beneficial than the same crop ploughed in. The object of producing the crop is an expected profit, through the animals consuming it; and on light soils there is the consolidation of the land, which renders it more fit for corn growing. The crop is also returned to the land after mastication and passing through the alimentary canal, while the urine or liquid manure is a more powerful fertilizer than water as it exists in turnips or green fodder.

Most farmers would therefore declare in favour of consuming the crop on the ground, and securing the "feeding value" as well as the manurial value of the crop, and the mechanical advantages of treading by sheep. In this conclusion they are right, but it does not affect the general question of green manuring, the benefits of which rest on a firm basis. When there are mouths to eat a growing fodder crop it would be a sacrifice of valuable keep to plough it in, but there are seasons in which it is impossible to pass sheep over the land, in which farmers plough in roots in order to clear their land for spring corn. There is also clay land which is better for being lightened up rather than consolidated, and in such soils a mass of vegetable matter assists this object, as well as enriches the soil. Green-crop manuring may therefore take the form of an extension of the area devoted to fodder or manuring crops, rather than as indicating any preference for ploughing in growing green crops.

It cannot be too fully realized that all the nitrogen and mineral matter removed from the soil is returned *plus* a large quantity of organic matter, which moderates the tenacity of clay soils and increases the absorptive powers of light and sandy soils. There is also a fixation of nitrogen from the atmosphere, fully recognized in the case of leguminous crops, and probably possessed by Cruciferæ, although not so apparent. It came as a surprise to the managers of the Experimental Farm at Woburn that better wheat crops were

produced after mustard than after certain leguminous crops, and recent experiments have still further strengthened this view. The fact is, that mustard leaves the soil in a better mechanical condition than tares or vetches, and the rate of the decomposition of roots and herbage within the soil may have much to do with the result.

Neither must the root action be lost sight of (as see Tillage) nor the relative depths of roots, and their varying powers of pumping up nitrogen from the subsoil.

Growing crops are great conservers of nitrogen, for there is little waste through drainage as long as the soil is occupied by a network of active root fibres. This is the secret of the high nitrogen content of pasture-land, and equally applies to the cultivation of green crops. The effect of deep-searching roots is beneficial to the subsoil, and, as recently shown by Dr. J. A. Vöelcker, destructive of garlic. A growing crop focuses the nitrogen obtained from the soil, subsoil, and atmosphere, and restores them to the land when it is ploughed in.

There are many keen advocates of green-crop manuring, among whom is Dr. C. Harlan, who published a volume on the subject (Friends Printing House, Philadelphia), which in 1888 had reached its fourth edition. Professor Voorhees, Director of the New Jersey Agricultural Experiment Stations and of Rutgers College, deals with the subject as "nitrogen gatherers" in his excellent work on "Fertilizers". There are also numerous papers on green-crop manuring scattered through the back numbers of the Royal Agricultural Society's Journal, all of which clearly show the advantages of the system. Neither must the cleaning effects of a smothering crop be omitted as of high importance.

In vol. iv (ser. II, R.A.S.J.) are papers by Mr. Peter Love, Mr. G. Murray, and Mr. W. S. Wright well worthy of attention, especially the first. Mr. Love used white mustard on his otherwise bare fallows, and grew three crops in succession, the first being sown in May. This crop was ploughed in about midsummer, and the ground was immediately resown with a second crop, which was ploughed in about harvest-time. A third crop was then sown in time for ploughing in in autumn, and so luxuriant was the growth that special means had to be taken to roll it down and bury it under the furrow. The result was great fertility, and absolute freedom from couch, as the roots of that pernicious weed were absolutely exterminated. There is no seeding of weeds, and the land is brought into perfectly clean condition.

When we reflect upon the small cost of mustard seed, its rapid germination and growth, and contrast this enlightened system with the tedious tillages of an ordinary bare fallow, we cannot but wonder that these valuable lessons seem to have been forgotten. Seldom or ever do we see them put in practice, and yet three crops of mustard represent a very full dressing of yard manure, thoroughly distributed, and obtained without any cost of carting, or conversion of valuable straw into "dung". Truly we may wonder at the blindness of many farmers to their own interests.

The crops usually grown for green manuring are, late-sown white turnips after vetches fed on the land, white mustard, buckwheat, clover, Hungarian millet, rye ; and, among the leguminous crops, red and crimson clovers and lupins. Vetches are also used, but are not a good preparation for wheat.

Turnips and swedes are often ploughed in in spring, when there is a plethora of keep and surplus roots must be got rid of. They are crushed down with heavy crosskill rollers, and ploughed under ; but they are too substantial for neat work, and slow in decomposing. They are also liable to develop seed stems and disfigure a cornfield, and are therefore not so well adapted for the purpose of green manuring as plants of herbaceous growth with fibrous roots.

Another development of this system, which might be carried out on a much wider scale, is the sowing of catch crops upon stubbles. This is practised extensively in Wilts, Hants, and other south-country chalk counties for providing sheep keep in the spring, and the land is then broken up and drilled with roots. The action of growing crops in preventing the waste of nitrogen suggests a more extended use of this system, even if the crops are ploughed in.

**Guanos.**—Guanos occupy a middle position between excrementitious and artificial, or special, manures. They are natural, in so far as they are composed of the excreta of birds or bats, but in many cases have been modified by the action of salt water and become rocky in character. They are therefore divided into nitrogenous and phosphatic, according to the predominance of either ingredient. There are a large number of them, which are named after the locality where they are found.

The original source was Peru, and the native name was Huana, which simply means dung. The first cargo arrived in England in 1840 and made a great and lasting impression. The original deposits of Peruvian guano have long been practically exhausted, but during the thirty years in which they lasted, guano produced a wonderful change in the disposition of farmers towards small dressings of a portable substance, which was found to be as efficacious as farm-yard manure. Peruvian guano therefore paved the way for artificial manures, and for the application of hundredweights instead of tons per acre. This, it is true, had already to some extent been effected by the use of crushed bones, but the combination of nitrogen and phosphates in guano produced more striking effects, and the introduction of guano constituted an era in agricultural progress. The best Chincas guano contained 14 to 16 per cent of nitrogen, and 12 to 14 per cent of phosphoric acid, so that it actually represented a mixture of nitrate of soda and superphosphate. It only contained 2 per cent of potash, and in this respect was inferior to farm-yard manure ; but a combination of it and the ordinary product of the farm-yard seemed to give everything necessary for keeping up the fertility of soils.

Owing to the varied and often inferior quality of more recently discovered guanos, importations have decreased to a mere fraction of what they were originally were. The word guano is now applied to a great variety of manures, some of which may be worthy of the name,

or may be the result of various mixtures of refuse animal and vegetable matter collected from miscellaneous sources and presented as guanos.

Phosphatic guanos have been imported from a large number of places (Aikman enumerates twenty), but present sources seem to be confined to about seven. They contain from 28 to 39 per cent of phosphoric acid (equal to from 52 to 85 per cent of tricalcic phosphate), and are used in the manufacture of superphosphate, after they have been reduced to a fine powder.

## CHAPTER V.

### SPECIAL MANURES.

ALL the manures mentioned in the previous chapter, except soot and gas-lime, may fairly be considered as complete or general. They are derived from vegetable and animal tissues, and therefore contain nitrogen and mineral matter in approximately the best proportions for plant nutrition. They fail in effect in the following cases: first, when applied to crops which have special requirements, and, secondly, when used on land which is notably deficient in some particular constituent. They are also in a sense wasteful, as they tend to accumulate certain constituents in unnecessary quantities, but are a safeguard against the exhaustion of the same elements.

**Efficacy of Pure Salts.**—The rotten and offensive character of manure, its strong smell, clammy nature, and dark colour, are associated in the minds of many farmers with fertilizing properties. That such materials when incorporated with the soil should enrich it is accepted as beyond question, and the explanation is that they contain plant food. Further investigation and experiment have, however, conclusively shown that this, although substantially true, is not quite accurate, and that before rotten vegetable and animal matter can be used by plants it must be completely resolved into pure salts. Farm-yard manure is a source of nitrogen which is finally presented in the same state as it exists in nitrates of soda, potash, or lime; the potash and phosphoric acid in organic combination in farm-yard manure must be liberated before they can be absorbed by the spongioles of the root fibres, and hence the essential difference between natural and mineral or artificial manures breaks down at the first touch of inquiry.

We may even go a step further, for it has been shown that the fastidious roots of flowering plants turn away from sour and offensive matter, and only absorb the products of complete decay, which are, like the products of combustion, composed of such simple materials as nitrates of lime, or of alkalies, phosphates of lime, or of potash, ferric oxide, sulphates, silicates of soda, or carbonates. Thus natural and artificial manures find a common basis, and the line of demarcation is obliterated. This is very elementary agricultural science, but requires to be enforced, as there are still many farmers who entertain a lurking suspicion that artificial manures exhaust the land or are the cause of diseases in crops. These fears are unfounded

so far as manurial action is concerned, and any evils which arise from the injudicious use of artificial manures must be accounted for on other grounds.

**Alleged Exhaustion of the Land by Artificial Manures.**—In order to understand soil exhaustion, it is necessary to appreciate the fact that a large number of constituents are required to build up a crop, and that if one of them is absent full development is impossible. Farm-yard manure, as already explained, contains all the constituents of plants, and is therefore competent to keep up fertility. Artificial manures only contain special ingredients, and if a favourite fertilizer, such as nitrate of soda, is too often used, it may lead to the exhaustion of phosphoric acid or potash, in which case the nitrate of soda may be said to have exhausted the soil. The real fact is that the farmer has himself exhausted it by injudiciously working one particular fertilizer to the exclusion of others. It is quite possible to construct a complete or general manure by combining a very few artificial fertilizers, or by applying them at different periods of a rotation. It is many years since the late Professor Baldwin of Dublin advocated in his lectures a rotation of manures as well as a rotation of crops; and Liebig, in his *Laws of Husbandry*, explained the "law of minimum", which simply means that the fertility of land is destroyed if any one important constituent is allowed to become exhausted. The plea that artificial manures exhaust soils is a mere unfounded allegation, supported by cases in which the blame does not attach to the manure but to the way in which it was employed.

**Artificial Manures increase the amount of Farm-yard Manure.**—To those who pin their faith on yard-made manures, it may be well to show that the stock of manure on a farm is easily increased by the use of artificial manures; and this can be demonstrated in a very few words. No one doubts the effect of nitrate of soda in increasing the yield of straw, or of superphosphate in increasing the weight of a turnip crop; and by bringing these results together the mass of farm-yard manure must be increased. Similarly, nitrate of soda increases the yield of clover, vetches, grass, cabbages, and almost all fodder crops, so that the head of live stock, and the amount of manure made, is much increased, and in this way the decried nitrate of soda is converted into the much extolled farm-yard manure.

**Classification of Special Manures.**—Special manures are classified as nitrogenous and mineral, although there is no scientific reason why nitrogen, hydrogen, or carbon should be considered as non-minerals; for hydrogen has been regarded as a volatilized metal, and nitrogen is the predominating constituent of the air.

The distinction means, that, in the first class of manures, combined nitrogen is the principal ingredient, while in the latter it is either entirely absent, or exists in a subordinate position. Nitrogenous manures are of organic origin; for even nitrate of soda, which might be described as a mineral, was probably derived from seaweed or guano. Mineral manures contain the ingredients of plant ash, and are employed to replace the mineral matter removed from the soil by crops. Nitrogen is essentially an ingredient of the combustible or volatile parts of plants, which points to an atmospheric origin.

The importance of nitrates as an ingredient of fertile soils places it in the first rank. It is the only plant food which is generated in the soil. It readily volatilizes into the air, and washes with special ease into drainage water. It is also required in large quantities for the formation of proteins or albuminoids, and without a full supply of it plants cannot appropriate mineral matter from the soil. The case of plants and animals in this respect is similar; for an animal deprived of nitrogenous food starves to death, through continuous waste of its tissues. This is nitrogen starvation, and may occur either to a plant or an animal. In the animal it is caused by excretion, and in the plant through actual deprivation.

A supply of nitrogen to a growing plant is as necessary as a supply of moisture, for if deprived of either it cannot avail itself of other descriptions of food. In this respect nitrogen does not differ from any other essential ingredient of the soil, except in degree. A soil destitute of phosphoric acid, potash, or lime is equally unable to support high-class vegetation; but complete absence of the mineral food of plants is comparatively rare, while a deficiency of nitrogen is so common that it becomes the weakest link in the chain of plant nutrition, and additions of it may be relied upon to increase the yield. What is called its "stimulating" effect is an inaccurate expression, for it exerts no stimulating action like that of alcohol or ammonia on animals. It is simply a food, and becomes a part of the tissues of the plant, which stimulants never do. If nitrate of soda exhausts land, it is only because it increases the crop. In this sense any manure is a stimulant, and so also is tillage. When a soil is deficient in lime it cannot support a fully-developed plant, and when this is the case a dressing of lime may produce a very striking effect. Lime has been said to exhaust land, but the true explanation is that other constituents of plant food should be added, so as to level up the supplies of available plant food. It is merely an application of the law of minimum as enunciated by Liebig, and it is a misuse of words to call it stimulating.

The effect of nitrates is immediate, because nitrogen is generally wanted; and transient, because of their solubility. If used exclusively for years in succession nitrates exhaust the soil, by a simple arithmetical process, and not by stimulation; and all that is necessary is to keep up the balance of foods in the soil, as is well shown in the continuous wheat-growing experiments at Rothamsted.

Further differences between Nitrates and Organic Nitrogen.—The gradual evolution of nitrates from farm-yard manure has already been mentioned, but deserves further notice in contrasting organic remains, containing nitrogen, with salts of nitric acid. Organic matter is a conservator of nitrogen, giving it out as nitrates, in presence of earthy or alkaline bases.

The process may be extremely slow, for the effects of liberal dressings of farm-yard manure have been recorded for fifty or sixty years after they have been discontinued. The late Sir John Lawes believed that the effect might last 100 years, and this durability of farm-yard manure is one of its most valuable features. On the other hand, nitrate of soda is eminently a one year, or one crop,



manure, and leaves little residual fertility behind it, chiefly on account of its solubility. The difference of behaviour of the two materials is not, however, all in favour of farm-yard manure, for it is inconsistent with the idea of quick returns. To recover capital expenditure as soon as possible is an accepted commercial principle, and the advantage of stocking land with potential fertility for many years to come may be compared to paying money in advance. If therefore a well-balanced system of manuring is followed, it is no disadvantage that nitrate of soda should exert an influence on one crop only, and, as already explained, it may and does react upon the amount of yard manure produced on the farm, and becomes permanent in its effects.

Where Nitrate of Soda should be used.—Nitrate of soda, which is really the most characteristic salt of nitric acid, exerts a beneficial effect on all kinds of vegetation, but especially upon gramineous herbage, which includes corn and grass crops. Its effect on wheat and oats is well known, as also upon Italian rye grass. It is a good dressing for barley grown after a corn crop, but is not necessary after roots fed on the land by sheep. It is not usually applied to cruciferous root crops, but even on swedes and turnips a top dressing of nitrate of soda is often beneficial. Its action on rape and cabbages (both cruciferous plants) is very pronounced, and this is in accordance with the observation that it acts especially upon the leaves and stems. It is accused of encouraging the growth of straw rather than of grain, but there is no doubt as to its increasing both, under normal conditions.

The first effect of nitrate of soda is to produce a darker green in the young plants, accompanied with a broader blade in cereals, and rapid growth, both of which features appear a very few days after application. This darkening of the green is a healthy sign, but if nitrogen exists in excess, the crop is liable to assume a gross or blackish-green colour, which may lead to fungoid attacks, such as mildew and rust. Especially is this the case in wet seasons, and indicates an excess of available nitrogen. On the other hand, a pale-green colour shows a want of nitrogen and an excess of mineral food, and the object of the farmer is to preserve the balance between these two classes of plant food.

The application of nitrate of soda is in some respects a speculation, as success depends in a measure upon the season. In cold and wet seasons a farmer may regret having used it, but this result is of course impossible to foretell. The previous management is often a guide in this matter, as nitrate of soda need not be applied after close folding with sheep, or when it is known that the land is sufficiently rich to produce a good crop. It is always acceptable to a second corn crop; to clover, mixed aftermaths, and to mangels-wurzel. The natural order to which a crop belongs has always been considered to have bearings on the fertilizers used, but is not in all cases to be relied upon. Leguminous plants, for example, are supposed to be naturally equipped for obtaining nitrogen from the air, but notwithstanding this, young vetches and clover benefit from its application. It also produces an excellent effect on potatoes,

although heavy nitrogenous dressings predispose them to disease. Growers, however, accept this risk.

**Time, Quantity, and Methods of Application.**—Nitrate of soda is best applied from March to May to corn and grass crops, and  $1\frac{1}{2}$  cwt. per acre is a sufficient dressing. As it is difficult to distribute such a small quantity equally, it should be mixed with an equal, or double weight of common salt, sand, or earth; and in such cases the mixed dressing may be divided into two parts, and sown at twice. A dressing of 2 to 3 cwt. may be given to mangel-wurzel at the time of sowing, or partly when sown, and partly as a later top dressing, when the plants have been singled out, and again after the first horse-hoeing. The quickest and cheapest method of application is broadcasting by hand, and if done by two men following each other the distribution will be satisfactory. Manure distributors may also be used. Before sowing, the nitrate and salt should be reduced to a fine powder, screened, mixed carefully, and applied if possible on the same day.

**Ammonium Sulphate**, or sulphate of ammonia, is a product of gas manufacture, and is also obtained from shale, bones, horn, leather, and other animal substances rich in nitrogen. It may be regarded as a rival of nitrate of soda, and is almost as extensively used. Sulphate of ammonia is to be preferred to nitrate of soda for malting barley, and for potatoes, while nitrate of soda is better for mangel-wurzel and grass land. Sulphate of ammonia is richer in nitrogen than nitrate of soda, but is not quite so quick in its action. The ammonia requires to be changed first into nitrites and then into nitrates by certain species of bacteria, and this oxidizing process is more rapid in warm than in cold weather. Sulphate of ammonia is less liable to wash through the soil than nitrate of soda, and may therefore be applied earlier. It has even been used in the autumn on young wheat.

**Nitrate of Lime, Calcium Cyanamide, etc.**—Hitherto agriculturists have been dependent for their supply of nitrate of soda upon the "Caliche" beds of Chile, which contain from 40 to 50 per cent of the pure salt. These beds are estimated to be sufficient for the world's markets for about 100 years to come, and it is possible that other beds may be discovered.

The price, and the possibility of exhaustion, have stimulated the inventive faculty, and already various artificially produced lime nitrates are on the market. Among these are calcium cyanamide, or nitrogen lime, advertised recently as "nitrolim", and stated to be richer in nitrogen, and lower in price than nitrate of soda. It would occupy too much space to trace the progress of this invention or to describe the processes employed, but the combination of free nitrogen with oxygen is effected in two ways—one by the union of the two gases under the action of the electric spark, and the other by the passage of nitrogen gas over calcium carbide, the substance used in the manufacture of acetylene gas, at a high temperature.

The effect of electricity in producing nitric acid during thunderstorms has long been recognized, and the fertilizing effects of thunder rains has been attributed to this reaction. The rapid progress of

electrical engineering, and the recognition of the enormous forces latent in Niagara and all waterfalls, has during recent years resulted in the utilization of this power to a marvellous extent for many purposes, so that electric stations now abound both in America and Europe. It is therefore no matter of wonder that the production of nitric acid and its compounds (especially nitrate of lime) should now rank among the accomplished facts of applied science.

The first attempt to attain this object was made by Bradley and Lovejoy at Majara, but failed commercially through deficient electrical energy. Professor Berkeland and Mr. Eyde, by constructing electric furnaces of sufficient power, and supplying the most suitable electrical conditions, are now turning out many thousands of tons of nitrate of lime per annum. In 1909 the factory worked upon the Berkeland-Eyde principle at Notodden (Germany) was utilizing 40,000 horse-power and 26 furnaces; but extensions were in contemplation for obtaining 220,000 horse-power from the River Rjukan in Telemarken. The enterprise at Notodden is pronounced to be in every way a perfect success, and may be looked upon as having solved the momentous question of the future supply of combined nitrogen for the production of human food.

Nitrate of lime, as now supplied, is readily soluble in water, and when exposed to the air it absorbs an excess of moisture and deliquesces. This is a disadvantage which no doubt will be corrected in time, but, so far as its fertilizing effects are concerned, the artificial product is said to be equal to nitrate of soda, and will probably be cheaper.

**Phosphoric Acid and Phosphates.**—Nitric and phosphoric acids are the two most important constituents of a fertile soil. It might easily be shown that other constituents are of equal intrinsic importance, just as it might be shown that air is as important as food. The point is the relative abundance of the prime necessities of plant life, and in this respect both nitrates and phosphates are at a premium—the one because of its solubility, and its liability to resolve itself into free nitrogen; and the other because of its continuous depletion during many centuries of ignorance, and possibly its originally small quantity in many soils.

It is impossible to say which of these two plant foods is the more important, but it may be broadly stated that in most soils they are the controlling factors, and that applications of nitrates and phosphates are all that is necessary in order to maintain fertility. In making this statement it is not intended to disparage the importance of other ingredients of plant food, and this will be made clear in the section devoted to calcareous, potassic, and other manures. As to the remaining ash constituents of plants, it is always possible that they may exist in insufficient quantity in a soil, as, for example, magnesium, chlorine, and some rarer substances such as fluorine, and certain rare metals which do not appear in ordinary analyses. Still, our knowledge of soils shows that there is no want of silica, that iron is always present, that soda is widely distributed, and that carbon is easily derived from the air. These less important constituents also exist in most fertilizers, associated with phosphates,

activity equal to 61 per cent of monobasic phosphate, and the No. 2 fineness, of 58 per cent. On the whole, in consideration of the price, the No. 2 quality is generally recommended.

Basic slag is now very largely used both upon arable and pasture land, and has in many cases proved itself equal to superphosphate when applied directly to swedes, turnips, and rape.

Superphosphates made their first appearance as dissolved bones, but the supply was inadequate to the growing demand, and "bone-superphosphate" is now a myth. It is unnecessary here to enter at length on the chemistry of superphosphates, and that for two reasons. First, this is not a work on agricultural chemistry, and secondly the manufacture of superphosphate is explained in many books accessible to students. The process is itself simple, but complicated by many difficulties, such as the presence of carbonates of lime, or of compounds of iron and alumina, which absorb much acid, and often require an excessive quantity much to the detriment of the resulting superphosphate. The amount of sulphate of lime is always large, and Professor Hendrick writes on this point: "The principal constituent of superphosphate is not phosphate but gypsum, of which a large proportion is necessarily produced by the reactions which take place in the manufacture."

High-class superphosphates are made from Florida and North African sources, and may contain 34 to 40 per cent "soluble", while ordinary superphosphates only contain 25 to 26 per cent. Most farmers seem to prefer these lower percentages, as they are in greatest demand. They are, however, charged for at a higher rate per unit than the richer superphosphates, and naturally cost more in carriage and distribution. True economy suggests the higher grades.

There is a lamentable want of accuracy in the use of the word "soluble", which we are always told does not mean soluble but something else. This inaccurate expression is further encouraged by the Fertilizers and Feeding Stuffs Act, which enjoins that all percentages of phosphates are to be stated in terms of tribasic phosphate of lime. Twenty-six per cent soluble does not mean that 26 per cent of soluble phosphate is present, but that the soluble phosphate, when calculated into terms of insoluble tribasic, would be 26 per cent. As a matter of fact there is actually only 19.5 per cent of soluble monobasic phosphate; and in a high-grade superphosphate, warranted to contain 40 per cent "soluble", there is only 30 per cent really soluble phosphate. The degree of solubility of a phosphate depends upon the replacement of the water combined with the phosphoric acid by lime. The more lime with which it is combined the less soluble is the phosphate (Fig. 24).

Reprecipitation in the Soil.—As soon as a superphosphate is applied to the land the acid soluble phosphate is neutralized and precipitated in a fine state of division, whereby it is prevented from washing through the soil. It is, however, assimilable by plants, and this is why finely ground coprolitic flour has been found as effective as superphosphate. This neutralization of soluble monobasic phosphate in the soil ought to be sufficient answer to those who blame the "acidity" of superphosphates as the cause of finger and toe and

other ailments in root crops. All fertile soils are alkaline in reaction. An acid fertile soil is scarcely imaginable, although certain soils are wanting in alkalinity, or in basic properties. A soil which turns blue litmus paper red evidently requires to be copiously limed, and thoroughly drained and aerated, before it can be successfully cultivated. It therefore seems improbable that a dressing of superphosphato which is instantly rendered alkaline, and converted into dibasic phosphate, can exert any corroding or injurious effect on a growing crop.

**Basic Superphosphate** is produced by mixing finely ground lime with ordinary superphosphate. The effect is to convert monobasic into dibasic phosphate, and the object is to produce a superphosphate suitable for soils which are thought to be either acid or insufficiently alkaline. It is claimed for this class of fertilizers, that they are suitable for land on which swedes develop finger and toe. Also that they are in some respects superior to basic cinder.

**Potash.**—The name potash indicates the original method of obtaining it by lixiviation and evaporation to dryness. It is an important and characteristic constituent of all vegetable ashes, and, as these are acknowledged fertilizers, the importance of potash as a manurial agent is fully supported. Potash exists in the soil in quantities often represented by 1 to 1.5 per cent, but in other cases by .75 per cent. Its presence in the soil is accounted for by the wide distribution of felspar and mica, derived from volcanic and crystalline rocks, but also from their derivatives, the plutonic and metamorphic rocks—granite, syenite, gneiss, and mica slate. Native clays are known to have been produced by the decay of granitic rocks, and are all rich in potash, so that it is found in all argillaceous soils. Felspar also occurs in many sandstones in the form of angular fragments. Potash is present in limestones, and may be said to be both abundant and widely distributed. Micaceous and shell sands also contain it, and thus even light sandy soils may hold sufficient for all practical purposes.

Another feature affecting the manurial value of potash is that it is in a great measure restored to the soil in straw and haulm. Thus, although a wheat crop of 30 bushels per acre actually takes up 28 lb. of potash, 20 lb. of it are returned in the straw. The manurial value of potash is therefore restricted either to soils in which it is deficient, or to crops which take it up in large quantities. A 20 ton crop of turnips, for example, removes 176 lb. of potash, which, if the crop is fed on the land, is mostly restored. A crop of 30 bushels of beans with its straw takes up 67 lb. of potash, and red clover and all leguminous crops are greedy of it.

All these crops require this constituent during their growth, even if it is returned to the soil, and therefore may benefit by its use. Mangels use potash at the rate of 13.6 lb. per ton, so that a crop of 40 tons per acre will take up 544 lb. And yet experiments conducted at Rothamsted for many years failed to show any distinct increase in this crop from its use. It, however, influences the amount of sugar, which is a matter of importance in all root crops. Sodium salts, particularly, replace potassium, and this may account for the

beneficial action of dressings of common salt upon mangel-wurzel, as well as upon wheat. Its effects are, however, greatly dependent upon the season, and it is instructive that it is less beneficial to clay soils, which are naturally rich in potash, than to light lands.

Potash is found in great abundance in the young shoots of all shrubs, trees, and grasses, and disappears to a considerable extent from old herbage. Etiolated or blanched straw, and dead leaves, contain much less potash than green leaves, it being replaced by lime. Hay crops, when cut early, therefore remove a great deal of potash, as do also green crops of all kinds sold off the premises. Meadow hay contains 34 lb. to the ton, potatoes contain 12·8 lb. per ton, all of which is removed from the land—always an important consideration. The sales of roots, cabbages, hay, straw, and potatoes must therefore entail a heavy drain upon the available potash in a soil, and show where it may be most successfully applied.

Potassic manures are less appreciated by farmers than either nitrates or phosphates, although nitrate of potash has always been esteemed as a fertilizer. The nitrogen in nitrates of potash, soda, or lime is, however, so potent as in a great measure to mask the effects of the alkalies or alkaline earths with which it is combined.

The best-known potassic fertilizer is kainit, which contains about 12-13 per cent of potash, associated with common salt and sulphates or chlorides of magnesium. Its introduction is comparatively modern (1862), and was due to the discovery of thick deposits of crude potash salts overlying immense masses of rock-salt at Stassfurt and Leopoldshall. In these vast saline deposits the lowermost layers are composed of pure rock-salt, overlaid by 100 feet in thickness of polyhallite, rich in potassium sulphate. Above this is a 90 ft. thickness of kieserite or magnesium sulphate, mixed with potassium and magnesium chlorides. Lastly there is a 90 ft. bed of carnallite, which is the chief source of kainit. These salts are now purified and sold as muriates and sulphates of potash, or as kainit, which is an impure form of the sulphate, and therefore less costly.

The sulphate is preferred to the chloride, as its decomposition in the soil is less likely to result in injurious compounds. Chloride of potassium gives rise to chloride of lime by double decomposition—a substance which is injurious to plants. This cannot occur in the case of sulphate of potash, as the sulphate of lime which may be formed is itself a recognized manure. Most of the commercial sulphates of potash contain the chloride, and it is urged on behalf of the chloride of lime that it is richer in alkali, and that it diffuses more readily through the soil than the sulphate. Both of these manures are largely used, without any bad effect, for clover, corn, grass, and root crops.

Potash is held in the soil with great tenacity, for, although it is extremely soluble in water, it is retained by the compound soil particles. These manures may therefore be applied in the autumn, and on the light soils of Norfolk autumnal application is found to be superior in its effects to applications in spring.

Soda.—Soda is so generally distributed throughout nature as to seriously obscure the results of spectrum analysis. A loop of platinum

will, if touched by the fingers, show the yellow glow of sodium in the blow-pipe flame. It exists in all animal and vegetable tissues, and traces of it occur in every mineral. It is the chief ingredient in common salt, and occurs in such vast quantities in sea-water as to be incalculable.

A substance so generally distributed is not likely to be wanting in soils, and its sources are similar to those of potash. There are soda felspars (albite) as well as potash felspars (orthoclase). Soda is found in all felspars, and in hornblendes and from these and other sources it finds its way into the soil. It may also be detected in rain by the silver nitrate test, especially when sea-fret has been carried over the Atlantic by boisterous winds. Soda has generally been regarded as a negligible constituent in soils, and it may even be used as an adulterant, to increase the proportion of "alkalies".

Silicate of soda has been used at Rothamsted as an ingredient of complete mineral manures, but in scanning the results, with and without it, no very distinct variation can be traced. Its presence in nitrate of soda is unimportant from a fertilizing point of view, but recent investigations have shown that soda can replace potash to a certain extent. Thus Hellriegel showed that an appreciably larger quantity of dry matter is produced in barley when sodium salts are added to potash salts, and this has been supported by Breazeale. The conclusion arrived at by Dr. E. J. Russell is, that "Sodium can partially, but not completely, replace potassium as a plant nutrient; it thus delays potash starvation, but will not keep it off altogether".

Soda is so universally present in soils that it commands no unit value in fertilizers. Common salt is composed of sodium and chlorine, and has long been employed for the land. Its manurial properties are mentioned in the Bible in a well-known passage, and it is highly esteemed by many agriculturists as a top dressing for wheat. It is also beneficial for mangel-wurzel, and, being cheap, it is frequently used for other crops.

Common Salt deserves more extended notice than might be accorded to it as a mere source of sodium. It possesses antiseptic properties. It is also an insecticide, for no worm, slug, frog, toad, or ask can resist it. It is repulsive to wire-worms, and therefore possesses qualities beyond its fertilizing value. It is also a solvent, and may exercise an important function in liberating mineral silicates and phosphates. Some of these are more or less speculative attributes, but Liebig accounted for the potency of nitrate of soda, or Chili saltpetre, by assuming that it dissolved the mineral matter out of the soil; and a solution of common salt no doubt reacts upon insoluble mineral matter in the soil.

This function of common salt is thus explained by Dr. Aikman: "Experiments with a weak solution of salt on a soil by Peters and Eichorn, to test its solvent power, showed that the salt solution dissolved more than twice as much potash and nearly thirty times as much ammonia as did an equal quantity of pure water. When applied to the soil it seems chiefly to liberate lime and magnesia . . . to convert them into chlorides." The effect of common salt in

retaining moisture is attributed to this formation of calcium and magnesium chlorides, as both are deliquescent.

They are, however, injurious in other respects, and require to be associated with ordinary lime, if their toxic properties are to be neutralized.

Salt is considered to stiffen the stems of cereals, and to correct undue straw development after dressings of nitrate of soda. It is a cheap and convenient diluent when mixed with the more potent fertilizers, and assists in their more thorough distribution. Fishery salt may often be purchased at £1 per ton, and is improved for manurial purposes by the impurities it has taken up in the curing process.

**The Action of Common Salt on Crops.**—The action of salt on the wheat crop has already been noticed. Its effect on mangel-wurzel is well-known and has often been tested by experiments. In field trials instituted by Dr. Augustus Voelcker many years ago it was found that the maximum benefit was obtained from dressings of 5 to 7 cwt. per acre upon light soils in dry seasons, and this was accounted for by its absorptive powers towards moisture. The benefit from applications of salt to mangels is, however, no doubt due to the plant being an original inhabitant of the coast, from which it derives its botanical name of *Beta maritima*. The ash of mangel contains much soda, and according to Warrington a crop of 22 tons removes 118 lb. from an acre of land.

Salt is frequently applied for the double object of manuring and of destroying, or driving away, wire-worms and slugs from growing crops, and may be classed with soot for this purpose. It is thought by many farmers to act as a check upon over-luxuriance in the straw, and to direct the action of nitrate of soda to the formation of grain. That it is a deterrent in several ways is certain, for it is an antiseptic, and probably checks the too rapid decay of organic matter. It is a recognized weed-killer when used in quantity upon gravel walks, but later it seems to stimulate a further weedy growth. Its action is not fully understood; moderate dressings are generally beneficial; but under no circumstances should it be applied to heavy retentive clays, as it renders them more difficult to work.

**Gypsum.**—Gypsum, also known as plaster of Paris, may be classed as a minor manure, but few fertilizers have been more strenuously advocated. To refer to the numerous pamphlets treating of its uses would occupy much space, but one or two facts regarding it may be of assistance to readers. In the first place it exists as sulphate of lime in all superphosphates. It is therefore held that, when superphosphates are regularly used, it is unnecessary to apply gypsum. It has, however, been found effective for clover, beans, and other leguminous plants, and is generally used as an absorbent of ammonia fumes in stables and manure heaps. Sulphate of lime is a common ingredient of all soils, but in spite of its many advocates is not classed among the principal fertilizers.

**Lime.**—Lime has already been referred to as an integral part of every fertile soil. Total absence of lime, as of any other constituent of plant ash, is fatal to the fertility of a soil. Not even vegetable



soils are entirely free from lime, but it occurs in large quantities in all calcareous soils. These are so vast in area as to cover most of this country. They include the Upper and Lower Chalk, the entire series of the limestones of the Upper, Middle, and Lower Oolites, the marls of the New and Old Red Sandstones, the Mountain Limestone, the marbles, and other metamorphic rocks.

Lime exists as an impurity in all clays, and calcareous sands are as common as those of siliceous character, so that lime is one of the most widely distributed and abundant of minerals.

**Scarcity of Lime in some Soils.**—It seems therefore remarkable to find soils which are deficient in lime, but this is not at all uncommon. Deficiency is due to the following causes: (1) normal constitution as in the case of siliceous sands, peats, and certain clays; (2) to the disposition of lime to dissolve as bicarbonate in the presence of organic matter, and to reprecipitate, as insoluble carbonate, at a lower level; (3) the exhaustion of a limited amount of lime by the removal of crops which contain it in large quantities.

From one or other of these causes liming becomes necessary, but, owing to its general distribution, few soils are far removed from available sources of lime. There are exceptions, as for example in parts of Wales, but as a rule, it is obtainable at small cost.

**Carbonate of Lime.**—When lime is spoken of by farmers, carbonate of lime is always meant. Soils contain phosphates, sulphates, humates, ulmates, nitrates, and other salts of lime, but when they require liming none are used except the carbonate.

It is really a hydrated carbonate, and, when burnt, the carbon dioxide and water are driven off, and hot or caustic lime is the result—a material which exhibits a great avidity for re-absorbing both of these ingredients. Calcined or burnt lime is often spoken of as “lime shells”, on account of its lightness and open texture, and it immediately begins to slake, or “fall”, when water is added, with considerable evolution of heat, owing to the water being changed from a liquid to a solid condition. The slaked lime continues to be dry and powdery, but it has nevertheless absorbed water, and if exposure is continued it takes up carbonic acid, and once more becomes hydrated carbonate of lime. When sand or gravel is added, silicate of lime is formed, and mortar, concrete, or cements are the result. Similar changes occur within the soil when lime is added as a dressing.

**Why Liming is necessary.**—When a soil, from any of the above-named causes, is found to be deficient in carbonate of lime, the remedy is simple. So common is the want of lime that the recommendation to apply it is the most obvious remedy which occurs to any practical agriculturist or agricultural chemist.

If a soil is “sour”; if it is newly broken up from pasture or waste; if it has been reclaimed from a boggy condition; if it is worn out by exhaustive cropping; if pastures or meadow land exhibit coarseness of herbage; if land is addicted to “finger and toe”; if potatoes are rough-skinned or scabby, or if a field produces stunted or diseased herbage, the first suggestion offered is to lime it.

**The Functions of Lime.**—Lime is unquestionably a plant food, but the effects of dressings of quick or caustic lime, or of ground

lime, go far beyond the mere nutrient value of lime *per se*. It is the salifiable base which unites with nascent nitric acid to form nitrate of lime, the chief form in which nitrogen enters the roots of plants. It neutralizes vegetable acids, and forms insoluble lime salts, which cease to give an acid reaction and to render soils sour. It exerts a marked effect on decomposing vegetable matter, converting it into plant food. It combines with the mineral constituents of soils to form silicates and zeolites. It neutralizes the toxic effects of magnesium salts, and of potassium cyanides. It seems to check other toxic effects, when mixed with substances which, if used alone, affect vegetation injuriously. It also alters the mechanical or textural character of soils, mitigating the tenacity of clays, and binding together particles of siliceous sand.

Its effect on vegetable matter in composts has already been mentioned, and it no doubt produces similar effects on soils rich in the same materials. Lime, as usually met with, is not a pure carbonate, for all limestones contain salts of magnesia and iron, and many of them considerable amounts of phosphates, sulphates, and other mineral salts.

**Different Forms of Lime.**—Lime is applied in various conditions, such as hot, slaked, and ground; and as chalk, marl, and basic cinder. Dressings sometimes take the form of applications of many tons to the acre, and sometimes of only a few hundredweights. Sometimes it is applied at long intervals of time, and sometimes to each crop. All these methods of liming are practised, but of late years small quantities of ground lime have come into favour, and the extremely heavy dressings of forty years ago have been largely discontinued. A generation since it was so ordinary to lime land once in fifteen years or so, that neighbours guessed that a new lease had been granted if they saw the farmer carting lime.

Of the two commonest kinds of limestone, the blue mountain is preferred to dolomite or magnesian, but oolitic limestone and chalk are also largely used in the calcined condition. Slaked burnt lime is not only caustic and "quick" in its action, but is also in an extremely fine state of division. It is for this reason troublesome to apply, as it rises in dense clouds which irritate the eyes and skins of the workers, penetrate the coats of the horses, and injure the harness.

The work is therefore performed early in the morning, before the air is hot, and the men bring home their teams at 9 o'clock, and do nothing else the remainder of the day. According to this system, 9 tons per acre is thought a heavy dressing, 6 tons a moderate one, and 3 tons a light one, which is in striking contrast to 5 or 10 cwt. per acre of ground lime. When lime is applied upon the older principle it is carted from the kiln and deposited in large heaps or clamps, on vacant land, and covered with a coat of soil. After three or four weeks the "shells" will be found to be replaced by a mass of slaked lime, and a stick may then be pushed through the heap to the bottom, without meeting with any obstruction, and the lime is then ready for application. It is usually used upon bare fallows, or upon land about to be broken up from old sward. It is a mistake

to apply both lime and dung at the same time, as the caustic lime liberates ammonia.

**Ground Lime.**—The employment of ground lime, either after burning, or as finely ground limestone, has received much attention from agriculturists and chemists during the last decade. It is noteworthy that there is no reference to or mention of it in Dr. Aikman's book on manures published in 1894. Since that time, and especially since 1900, few innovations have made greater progress than that of the application of from 5 to 10 or more cwt. per acre of this material.

As to whether burning or calcining is necessary, the question is somewhat complicated. On the one hand it is said that the chemical composition of finely-ground limestone is similar to that of slaked lime, and experiments have indicated that the results are not inferior. Further experiments are, however, needed. On the other hand the chemical condition is not quite the same, for burnt lime remains in a caustic condition for a long time after it has been slaked with moisture. It absorbs water first, and falls to powder, but still continues to take up carbon dioxide from the air, until it reverts to the condition of the hydrated carbonate.

It is also difficult to reduce limestone to the extremely fine condition of slaked lime by disintegrators, and the expense is greater than by simple exposure to the air. As to basic cinder which has been compared with ground limestone, the two cases are not parallel, for basic cinder has been burnt, and is drawn from the furnace in a more friable condition than native limestone from the quarry. The fineness of the powder, and the caustic condition of newly slaked lime, are both very important, and so much so that the system of slaking in large heaps and applying in the caustic condition is allowed to be better than slaking in small heaps. The reasons for this are that in large heaps the lime still retains its caustic properties, while in small heaps it is less perfectly reduced to powder, is in fact liable to be rendered pasty through excessive wet, and also to absorb carbonic acid and become too mild. The benefits of the finest possible state of division and the preservation of caustic properties are on the side of burnt lime; and the action of ground limestone upon vegetable matter is less rapid, if exerted at all. Neither does it seem likely that ground limestone will exercise the same influence in coagulating the clay, and inducing the colloidal condition already described in connexion with the constitution of soils.

The expression "ground lime" is too often used without explanation as to whether it means ground shells of burnt lime, or simply ground limestone.

The effects of small and frequent dressings of lime on hay and root crops is certainly very marked, as may be seen in the photographic representation exhibited at the Royal Agricultural Society's Side Shows, and other places. Lime is so thoroughly appreciated by every farmer and gardener, and so immediately suggested for every failing of land or diseased condition of crops, that it is remarkable to notice the renewed interest recently taken in it as a fertilizer. It is a many-sided material. It solved the question of removing phosphorus from

iron, and it has been found to soften hard water, although the very hardness is due to lime in solution. It is always cropping up in new ways to such a degree that it might be suggested as a remedy on *a priori* grounds, even before direct experiments have been instituted.

**The Evils of Over-liming.**—That land may be over-limed is simply due to an infringement of the law of minimum. The exhausting effects of repeated liming is one of the oldest axioms in practical farming, embodied in both rhyme and prose. Few have not heard that "The use of lime without manure will make both land and farmer poor". Or that lime "enriches the father, but impoverishes the son". The same is true of nitrate of soda, and might be of super-phosphate of lime.

The balance of fertilizing matter must be maintained by the use of all the constituents of plants, and it is this principle which lies at the foundation of the high esteem in which farm-yard and other general manures are held. The blame should not be laid at the door of the fertilizer but of the farmer, who pins his faith to one particular kind of manure.

#### UNIT VALUES OF MANURES.

Manures are valued commercially by the amounts of nitrogen, phosphates, and potash they contain; not because these are the only valuable ingredients, but because the remaining constituents are abundant in the soil, or may be replaced by natural manures.

The above three substances exist in many forms. Thus nitrogen may be in organic combination as in farm-yard manure, or as nitric acid, or as ammonia. Phosphates may be soluble or insoluble, and ammonia may be in combination with various acids, either in a fixed or a volatile form.

The percentage in which each of these ingredients exists in a manure is the basis of valuation by unit, but the value of each depends upon its availability or solubility.

**Unit Value of Nitrogen.**—Nitrogen itself is an inert gas of no manurial value, but in combination it becomes one of the most characteristic elements in foods and in fertilizers, and, it might be added, in explosives. It is only in combination that it exhibits these properties, and for this reason is always valued in terms of ammonia.

This is convenient, because in ammonia the nitrogen is combined with one element only, namely hydrogen, and the proportion of nitrogen to ammonia is as 3.5 : 4.2. Thus, if the nitrogen in any compound is increased in this proportion, the ammonia it represents is arrived at.

This method of valuation is unsatisfactory as regards nitrogen, because the nitrogen in a given material may be in a condition in which it is evolved very slowly, as for example in bone meal. To calculate the nitrogen in bone meal into terms of ammonia is misleading, because it does not exist in that form, but in organic combination, which may resist change for a lengthened period. Nitrate of soda stands on a different footing altogether, for it contains

15.5 per cent of nitrogen in a highly available form, which, when calculated as ammonia, is represented by 18.6 per cent. The value of a unit of ammonia therefore depends upon its state of combination in any given material, and this is especially misleading in the case of mixed fertilizers in which nitrogen exists in various forms.

**Cases in point.**—Sulphate of ammonia of guaranteed purity of 97 per cent contains 24 per cent of ammonia, and if the price is £11 10s. per ton the ammonia is bought at 9s. 7d. per unit, i.e.  $\frac{£11\ 10s.}{24} = 9s. 7d.$  Or, if nitrate of soda of 95 per cent purity containing 15.5 of nitrogen or 19 per cent of ammonia is bought at £10 5s. per ton, the ammonia is bought at 10s. 9½d. per unit. If, however, horn dust or dried blood is bought at £8 5s. a ton and contains 15 per cent of ammonia, it is bought at the rate of 11s. per unit, and, considering its slower action, it is dearly bought in comparison with either sulphate of ammonia or nitrate of soda.

**Unit Value of Phosphates.**—The system of representing soluble phosphate at 26 per cent, when it is in reality only 19.5, has been already explained. It may, however, be well to remind readers that the declared percentage of soluble or monocalcic phosphate is arrived at by calculation, and really means the amount of tribasic phosphate which the actual monobasic phosphate present would make. It is an unfortunate method, for most farmers probably rush at once to the conclusion that the manure contains the amount of soluble phosphate printed on the bag. If bought at £2 10s. per ton, 20 per cent of actual soluble phosphate evidently means 2s. 6d. a unit if valued solely in the soluble; but if 26 per cent is taken it is bought at 1s. 11d. per unit.

The usual figures employed for undissolved phosphates are certainly inapplicable, for neither 20 nor 26 per cent accurately fits the case. Both dissolved and undissolved phosphates are capable of being valued by unit, and the following case may be used in illustration. It is that of a mineral superphosphate of the following composition:—

	Per cent.
Water . . . . .	12.58
Organic matter and water of constitution <sup>1</sup>	15.35
Monocalcic phosphate <sup>2</sup> . . . . .	19.47
Tricalcic phosphate . . . . .	7.59
Calcium sulphate . . . . .	37.47
Silica . . . . .	4.07
Alkalies, iron, etc. . . . .	3.47
	100.00

In this analysis both aspects are shown. There is absolutely 19.47 of monobasic or soluble phosphate represented by 25.79 per cent of tribasic phosphate. It is therefore easy to apply figures, and we tentatively value the monobasic at 3s. per unit and the tribasic phosphate at current prices, which are taken as about 1s. 11d.

<sup>1</sup> Containing traces only of nitrogen.  
<sup>2</sup> Equal to 25.79 of bone earth rendered soluble.

Applying these figures the commercial value of this particular superphosphate is arrived at as follows :—

	£	s.	d.
19.5 units of monocalcic phosphate at 3s.		2	18
7.6 units of tribasic phosphate at 1s. 11d.			6
Total value of phosphates . . .	£3	13	0

All superphosphates contain a percentage of tribasic and of dibasic phosphates, so that the calculation as to their value should include them as well as the soluble phosphates. The prices per unit for undissolved phosphates depend upon their source, and vary from 1s. 3d. in the case of bone meal, to 1s. 11d. in superphosphate. In dissolved phosphates it is valued at from 2s. to 2s. 6d. per unit.

The phosphates in basic slag are in a tetrabasic condition, and are valued at about 1s. 2d. per unit. If the cinder contains 30 per cent of phosphate at 1s. 2d. per unit the price should be about £1 13s. per ton, and if 40 per cent, £2 4s. per ton.

**Unit Value of Potash.**—Sulphate of potash of 50 per cent purity guaranteed to contain 27 per cent of potash at 3s. 10d. per unit costs £5 5s. per ton. Muriate of potash of 80 per cent purity, containing 50 per cent potash valued at 3s. 6d. per unit, would be sold at £8 15s. per ton. Kainit, if containing 12 per cent of potash valued at 3s. 4d. per unit, would be sold for £2 per ton.

**Mixed Fertilizers.**—When a fertilizer contains appreciable amounts of two or more valuable constituents, the sum of the values must be ascertained by taking them out separately and adding them together. Thus nitrate of potash containing equivalent to 14 per cent of ammonia and 40 per cent of potash would be valued as follows :—

	£	s.	
14 per cent of ammonia at 10s. . .	7	0	
40 per cent of potash at 3s. 9d. . .		7	
Total value . . .	£14	10	

In valuing manures considerable caution is necessary on account of the varied condition in which the fertilizing matter may occur, and a farmer would find it pay him well to submit any sample to a competent analyst before purchasing it in quantity. Fertilizers of a mixed nature are particularly deceptive, for although they may contain a high percentage of nitrogen and phosphoric acid it is important to know in what condition, or combination, they exist.

**Food Residues.**—The valuation of food residues presents greater difficulties than that of artificial manures, because their fertilizing matter is in organic combination, and requires time for its release. This aspect of food residues has often been stated to be a recommendation, because they last for many years ; but, on the other hand, it renders their action slow. In most artificial manures the fertilizing elements are soluble, immediately diffusible, and readily assimilable, whereas food residues are for the most part insoluble and therefore less diffusible and assimilable. They, however, partly exist as urine, in which case they are soluble, and as masticated residues,

which are at least in a finely divided state. Lastly, there is the preponderating bulk of litter, which is much slower in its action, and to which is in a great measure to be attributed the lasting nature of farm-yard manure.

That "dung" exerts an immediate action upon growing crops no one doubts, but this is due to the following causes :—

- (1) The liquid portion is quickly converted into ammonia and nitrates.
- (2) The solid excrementitious matter rapidly decomposes and yields up both its mineral and nitrogenous matter.
- (3) That even straw begins to decay as soon as it is mingled with the soil, or even sooner if it is placed in heaps and partially rotted.

Hence well-rotted manure is quicker in its action than fresh strawy stuff taken direct from the yards, and so rapid is it in its effects that it may equal those of artificial manures.

The durability, or what may even be called the permanence, of farm-yard manure is one of its main attributes ; and if purchased cheaply, or if it can be regarded merely as a by-product of profitable feeding, it is quite possible that its cost may be almost nominal. The actual cost of its production is impossible to arrive at even approximately, for it is in inverse ratio with the profit on the animals which yield it. Ordinary stock or ordinarily produced beef and mutton may run up a bill for food purchased which cannot be balanced without a credit for manure left on the holding. In high-class stock the cost of the food and the value of the manure sink into comparative insignificance, compared with the prices obtainable for the animals themselves. Hence it is safe to say that the cost of the manure depends upon the commercial value of the stock which produces it, and it may easily be produced for nothing.

**Purchasing Farm-yard Manure.**—There is no better investment than cheap farm-yard manure, provided the cost of carriage is not excessive. Manure is in some cases regarded as a nuisance, and is given to anyone who will remove it ; but this is not equivalent to obtaining it for nothing, as the cost of haulage may even then exceed its value. Such purchases are most commonly made from towns and villages. Town-made manure may sometimes be brought back in empty carts and wagons, and in other cases a regular traffic is kept up of carting produce to a town and bringing manure back to the farm. It is an excellent system, because of the general character of the manure. It is a feature of suburban farming, and falls in with the plan of selling everything that is marketable, and keeping up the fertility of the land by constant importations of town-made manure. It is also consistent with milk production, and the sale of roots and vegetables.

There are many points in connexion with farm-yard manure which have already been discussed, but its residual value to an incoming tenant requires further remark. In the first place the sale of crops off the holding is in itself a bar to compensation for purchased fertilizers, for such sales could not be permitted without a *quid pro quo*

in the form of manure. A system of selling all produce would therefore appear to bar any claim for unexhausted fertility, unless the imports could be shown to be far in excess of the exports.

**Compensation for Foods purchased.**—The simplest mode of reimbursing a farmer for money spent upon purchased food is by adopting a scale of compensation based upon scientific inquiry. In this case the home-made yard manure is not valued nor paid for, except as regards the labour spent upon it. Such manure is assumed to belong to the farm as much as the soil itself, and could not be sold. Its enrichment from extraneous sources is the only matter for consideration, and this is arrived at by the amount of the expenditure upon purchased food during the last two or three years of tenancy.

The foods are classified as nitrogenous and non-nitrogenous, the former including oleaginous cakes, and other albuminoid or leguminous foods; the latter including cereal grains, rice-meal, maize, and all farinaceous foods. Nitrogenous foods are paid for at the rate of half the ascertained and calculated manurial values for the first year, and one quarter and one eighth respectively for the previous two years, while the non-nitrogenous food is assessed according to the merits of such food on the above bases as to time. It must always be remembered that any want of accuracy in the method of valuation practically corrects itself in the end, as long as the tenant quits on the same scale of compensation as he entered.

**Why Market Price of Foods is not taken as a Basis.**—The original idea was to base the valuation of manurial residues upon the market price of the foods, and as nitrogen content in a great measure regulates market price there was something to be said in favour of the system. Oil, however, is a controlling factor, and especially oils derived from certain sources such as linseed. Sugars, oils, fats, and starch have no manurial value, although they possess high fattening qualities, and the price of a food depends upon a favourable balance between proteins and farinaceous or oleaginous contents. The majority of the Chambers of Agriculture and valuers' associations have adopted the figures originally worked out by Lawes and Gilbert, and later modified by Hall and Voelcker; and these are based upon the three essentials of fertility—nitrogen, phosphoric acid, and potash.

There are, however, certain assumptions which can scarcely be held to be either scientific or accurate. In the first place the actual value of the manurial residues is divided by two, in order to meet the inevitable wastes due to the escape of fertilizing matter, washing by rain, waste in the field, and unfavourable seasonal conditions. Secondly, the effect is limited to four years, and the Central Chamber of Agriculture further restricted it to three. Both of these conditions are arbitrary, especially when it is acknowledged by all authorities that dressings of dung continue to show their effect on future crops for sixty or more years. Attempts have also been made by some Associations of Valuers to discriminate between badly, mediumly, and well farmed lands, but the difficulty is to make a valuation for each possible case; such, for example, as between breeding and fattening stock, as well as for other controlling circumstances presently to be mentioned.



UNIT VALUES OF MANURES.

The Actual Scale.—It now only remains to give the scale adopted by the Central Chamber of Agriculture, in order to bring Lawes' and Gilbert's figures up-to-date.

	Last year of tenancy.	Last year but one.	Last year but two.
	£ s. d.	£ s. d.	£ s. d.
Decorticated cotton cake . . . . .	2 16 0	1 8 0	0 14 0
Rape cake . . . . .	2 0 0	1 0 0	0 10 0
Linseed cake . . . . .	1 18 0	0 19 0	0 9 6
Malt culms . . . . .	1 16 0	0 18 0	0 9 0
Undecorticated cotton cake.	1 14 0	0 17 0	0 8 6
Coconut cake . . . . .			
Linseed . . . . .			
Beans . . . . .			
Peas . . . . .			
Bran . . . . .			
Pollards . . . . .			
Dried grains . . . . .	1 4 0	0 12 0	0 6 0
Palm-nut cake . . . . .	1 0 0	0 10 0	0 5 0
Malt . . . . .			
Wheat . . . . .			
Barley . . . . .			
Oats . . . . .			
Maize . . . . .			
Rice-meal . . . . .			
Locust beans . . . . .	0 12 0	0 6 0	0 3 0
Mangels, swedes, and turnips	0 2 6	0 1 6	—
Pure clover or sainfoin hay	1 0 0	0 10 0	—
Hay . . . . .	0 15 0	0 7 6	—
Straw . . . . .	0 7 0	0 4 0	—

Faults of the System.—Valuers must deal with food residues on broad lines, and can scarcely be expected to produce new scales for payment for every case. It is, however, hard upon an incoming tenant to have to pay on cake and corn consumed by milking cows, when the milk is sold off the premises. Or to pay for cake and corn consumed by a breeding flock, where the lambs are sold and carry away much nitrogenous matter in their flesh, and phosphates in their bones. This is shown best by contrast, for on a contiguous farm steers may be bought and fattened, and lambs purchased and sold as mutton. There is an evident difference in the amount of fertilizing matter left on the land in these two representative cases.

Another hardship is seen when the major part of the cake is fed upon land intended for spring corn, which, so far as residual fertility is concerned, "creams the bowl." If this is contrasted with the same amount of cake and corn spent in yards and boxes on fattening cattle, by which system the manure is left intact upon the holding for the succeeding year's wheat or other crops, the incoming tenant might well pay the bill with cheerfulness.

Compensation for Unexhausted Manures.—This section might include lime, marl, chalk, town manure, and waste product, all of

which are very durable. Scales of compensation have been adopted in many counties, but the subject is too complicated for treatment here.

Compensation is ordinarily given for phosphatic and other approved manures, applied to root or green crops consumed on the land, on the basis of actual cost. They are, in fact, included in the schedule of tillages with seed, hoeing, etc.

If an ameliorating cultivation is pursued for two years, both expenditures ought to be added together, and a deduction made on the first year. This is called half-tillages, which means that when a root or green crop has been consumed on the land only half the amount of the scheduled tillages is allowed for.

A corn crop bars all further compensation for ordinary dressings of manure, as does also a potato crop, or root and green crops sold off the holding. Nitrate of soda, sulphate of ammonia, and other soluble nitrogenous manures are considered to be exhausted in one year, but if applied to root crops left on the farm for the benefit of the landlord or incoming tenant, the expenditure should be included in the cost of production.

As to the duration of mineral manures (with the exception of lime, marl, and similar bulky materials), our knowledge is insufficient for constructing a scale for arable land crops. If, however, grazing land has been liberally dressed with basic cinder or superphosphate, compensation should be allowed on a three or four years' principle.

## CHAPTER VI.

### ROTATIONS OF CROPS.

THE tendency during recent years has been against a fixed rotation of crops. Legislation has relieved farmers from penalties against cross-cropping, and the sale of produce during the tenancy, excepting in its final years. During the last two he may be required to show that he has replaced the fertilizing matter removed by the sale of straw, hay, and roots, and that he leaves his farm in course for customary cropping by his successor.

This change in practice has been gradually brought about by better knowledge as to the conditions of fertility, and also by the large number of artificial manures now available. It has been demonstrated that corn crops need not exhaust the land, if it is well kept up in condition by the liberal use of fertilizing matter, whether in the form of manures or feeding stuffs. Good farmers would have no difficulty in showing that this condition has been more than fulfilled, but at the same time any claim for unexhausted fertility would probably be met by a counter claim for "waste" if produce could be shown to have been sold off the land. A sufficient head of live stock maintained during the tenancy is in itself a guarantee that fertility has been maintained, and vouchers for food purchased ought to be preserved for the inspection of valuers.

**The Theory of Rotations.**—The idea that plants leave excrementitious matter in the soil, which exerts an injurious effect upon a succeeding crop of the same nature, or in other words poisons the land, appears to have little foundation. There is no evidence in favour of the "excretory theory", but while this view may be sound it is also true that certain crops cannot be grown consecutively without deterioration. Among the best illustrations of this is red clover, and this alone suggests modifications in cropping. Sainfoin cannot be grown successfully, except after long intervals of time; turnips become liable to finger and toe (anbury); potatoes are apt to become rough or scabby; oats are found to deteriorate, if grown too frequently; certain garden crops need a change of soil, and other instances might be cited to show that a variety in cropping is advantageous. It is not necessary to assume excretions, but it does not follow that plant residues may not be injurious to a succeeding generation of the same plant.

There are, however, other considerations and observations which affect the question of rotations. If, for example, onions are grown for

many years in succession upon the same soil they become subject to maggot and mildew. This may not occur for many years, but disappointment from the above cause eventually suggests a change. A particular plant may encourage the propagation of germs of disease, ready to invade a succeeding crop of the same sort, such as potato disease spores for example. Or it may be, some form of rust or eel-worm which is best avoided by a change in cropping. Thus, although the excretory theory has been abandoned, there may be other circumstances which equally show the necessity of a rotation of crops.

A second point is the different ways and proportions in which plants seek for or require their food. Root distribution is an important consideration, for while some crops, such as barley, are shallow-rooted, others like wheat, lucerne, clover, beans, and sainfoin are deep-rooted. They take their food from a different section of the soil, and it is possible that when a field is exhausted for one species of plant it may be productive for another. Rapidity of development, and the time required for maturation, also affect the question of rotations, for barley requires its food near the surface and ready to hand, as it passes through all its stages in about four months. Wheat sown in October occupies the land for some ten months, and being deeper-rooted is less dependent upon an immediate supply of plant food. Hence farm-yard manure or decomposing clover roots are excellent for wheat, but too slow for barley.

Equally important is the varying proportion in which plants take up fertilizing matter. Cereal crops require phosphates for their grain and potash for their straw, and are largely dependent upon nitrates. Leguminous crops are storers of nitrogen, while corn crops have been spoken of as nitrogen wasters; mangel-wurzel is rich in potash and sodium chloride, and potatoes are great consumers of potash. Some crops are customarily grown for sale, while others are fed upon the holding; some crops are horse- and hand-hoed during their growth, and others tend to make land wild or foul. Rotations generally assume the form of alternations between crops for sale and crops for home use; cleaning crops, and those which do not allow of hoeing; exhausting and renovating crops—food for man and food for live stock. Rotations are thus built up gradually and unconsciously, for the established courses of cropping do not appear to have been so much invented as evolved.

**Different Lengths of Rotation.**—The length of a rotation may be less or more than four years, but what is known as the four-course is very widely used, and is capable of many modifications. In a sense it is a two-course system, in which grain crops alternate with fodder crops, for roots, barley, clover, and wheat may be thus described. Before entering upon its merits and capabilities it may be well to make a few remarks upon shorter systems.

**Continuous Cropping.**—The best example of continuous cropping is grass land, for here there is no rotation, except what is brought about by natural causes, or the effects upon the herbage of manuring or grazing. Continuous wheat-growing is not to be recommended, for the simple reason that to grow one crop in endless succession

subjects the soil to a scourging system, and precludes the cultivation of other crops, whose roots might revel in different sections of untouched food. A new crop which has never been previously grown is generally successful, provided it suits the soil and climate. The same objection may be raised against any system of continuous cultivation of a single crop.

**Two-course Systems.**—The best example of this method of cultivation is seen in this country when wheat and beans are grown alternately for many years in succession. This is less practised now than formerly, but it suits certain classes of clay soils. Beans may be grown at wide intervals, allowing of both hand and horse hoeing. They are leguminous, and therefore accumulators of nitrogen, and this suits a following crop of wheat.

Beans are also a valuable food for live stock, and their haulm is an excellent fodder. It may be doubtful whether root crops grown on very tenacious soils yield as much dry nutrient matter as beans. The two crops are also in harmony as to the time of sowing; for wheat may be followed by beans, and beans by autumn sown wheat, with great convenience.

**Three-field Systems.**—The oldest rotation in this country, and which at one time was universal, is the three-field course of fallow, wheat, beans or oats, also described as fallow, winter corn, and summer corn. This division of crops was much used until the introduction of clover, which was the principal means of converting it into a four- or six-course. The advent of root cultivation towards the close of the seventeenth century further modified it, by the substitution of turnips for bare fallow on all light lands.

**Four-year Systems.**—Clover displaced beans, and turnips superseded bare-fallows, and the result was a four-course system, which in its original form was expressed as roots, barley, clover, and wheat. This version of the Norfolk rotation, as it was called, is suitable for light soils, but can be readily altered to suit stronger land. Thus the bare-fallow may be partially retained; wheat may follow roots, and oats may be taken after clover. There is no change in principle between the Norfolk rotation as above set forth and fallow, wheat, clover, oats or wheat. Neither is it materially altered by varying the root crop in any required manner, or even by introducing potatoes. Clover also may give place to beans or peas, without altering the framework of the rotation, so that the four-course is not likely to be displaced, although in its stereotyped form it is said to be out-of-date.

In any of the above forms, the four-course rotation is wonderfully scientific, for a fallow is a fitting introduction to any definite course of cropping, and is an excellent preparation for wheat. Wheat, barley, or oats are suitable for sowing with grass seeds and clover, and these are in all respects a good preparation for wheat or oats.

**Five-year Systems.**—The simplest plan for converting a four- into a five-course system is to leave the clover and grass seeds down for a second year. Another method is to take an additional corn crop after wheat, at the close of the rotation. This is often done with success when the land is in good condition; and the course then assumes the form of roots, barley, clover, wheat, oats or barley. It

is by no means easy to frame any other system of five-year cropping without causing the land to become foul or poor.

**Six-course and longer Rotations.**—The three-course system is easily converted into one of six years by dividing the fourth year between roots and bare or summer fallow, and the third between clover and beans. The result is as follows : bare-fallow, wheat, clover, roots, oats or wheat, beans.

In this arrangement clover is chosen, before roots, because the land breaks up easier than it does after beans. Beans are taken after oats or wheat, as the last crop of the rotation, because bare-fallowing is to follow, and this secures the cleaning of the land for a new departure.

**Longer Rotations.**—There is practically no limit to the length of a rotation, if different root, corn, or green crops are regarded as not really causing a departure from the original plan. If the kind of corn is considered to be immaterial, the kind of root immaterial, or the kind of fodder, the rotation becomes merely an alternation between these classes of crops, and may still be considered as a four-course or alternate system of corn and fodder crops. If however, as is more generally thought, each crop is looked upon as a factor, then the length of the rotation will appear to be indefinitely prolonged. A few examples of long rotations will best illustrate the point.

*First.* Clover and grass seeds may be kept down for several years, and this system is much used in Cornwall and other western counties. It is, however, unsuitable for East Anglia, where the four-course is found to be better adapted for the climate.

*Second.* Sainfoin often comes in as a prolongation, and in many chalk districts one field is put down in it, every year. The plant under favourable circumstances will last seven years, thereby increasing the length of the rotation. The necessity of placing a long interval between sowings of sainfoin has already been mentioned, but it will be seen that if one field is sown each year, it will be long before the seeding is repeated on any particular field. In the meantime sainfoin, of different ages, greatly modifies the management, for it reduces the total area under tillage, and also the number of horses required, and the cost of labour.

*Third.* If variety is introduced in cropping, the four-course system may easily be made to represent a long series of crops extending over many years ; and, dividing the year's time into cycles of four, such a system of cropping might appear as follows : turnips, barley, clover, wheat ; swedes, oats, beans, wheat ; mangel-wurzel, wheat, potatoes, wheat ; rape or cabbage, wheat, sainfoin for seven years, etc.

In all these years, or at least until the land is seeded with sainfoin, the general framing of the four-course rotation is preserved.

As a working rotation the original four-course system is too short. Clover occurs too often, and turnips also ; but by varying the cropping within certain limitations, it remains a valuable principle to keep in mind.

**The Wiltshire Eight-course System.**—This is a modification of the four-course, suitable for the light chalk soils in Wiltshire and

Hampshire, where a system of catch-cropping is generally practised. It begins with the Norfolk rotation, and proceeds during the remaining four years by taking two root crops in succession, followed by two corn crops in succession. Given in bare terms of the main crops, it runs as follows: roots, barley, clover, wheat; roots, roots, wheat, barley. Catch crops are introduced before the root crops in each case, and are so arranged as to be cleared for early or late sown roots. Thus the roots, which begin the rotation, follow rye, winter barley, or trifolium consumed by sheep upon the land in time for swedes, which may be entirely folded or partly carted off. The next three crops follow as a matter of course. The second root crop (fifth year) is preceded by winter vetches which, after folding, are succeeded by what are called backward or late turnips, which stand the winter, and after folding in spring are broken up for forward or early turnips, which are again consumed on the land, and followed, first by wheat, and then by barley. Late-sown vetches may be cut for soiling, or converted into hay, in time for preparing the land for wheat.

By this system the clover crops are separated by an interval of eight years. The light soils of the downs are brought into high condition for wheat, and produce 40 to 50 bushels per acre, and a good quality of barley is grown after the wheat. The land is then cleaned and brought into condition for fodder crops and swedes. It will be noticed that in this system of cropping the land carries four corn crops in eight years, and three root crops. It is under crop the whole time, unless winter fallowing is resorted to for pieces which require special cleaning.

This is the best example of catch-cropping to be found in this country, and obtains extensively in the sheep-breeding counties of the southern counties, mostly on the soils of the Upper Chalk. It enables the farmers to maintain large flocks in summer, and is associated with the Hampshire breed of sheep. It entails a liberal use of artificial foods, and favours the production of high-priced lambs. It has not, however, extended beyond the easy working sheep lands of the south.

**Catch-cropping** aims at the production of two crops in one year. It possesses the merit of keeping the land continuously under crop, and thus prevents the nitrates from washing through the soil. Its weak point is the short period it allows for couching and cleaning, but this difficulty is easily surmounted by discarding a catch crop, and substituting autumn or winter fallowing in its place.

## CHAPTER VII.

### CEREAL CROPS.

We have been asked to say something as to the origin of our corn crops, as well as upon their principal variations, which are, however, innumerable, and always true to sort. The cereals are fertilized (Figs. 25, 26, 27) within closed walls, and are not naturally subject to cross fertilization. The process requires to be done artificially, and is being performed at Cambridge and other experimental centres with very promising results. It is not, however, to cross fertilization that we owe the vast array of varieties, but to the wonderful prepotency of the grain in propagating its peculiarities and transmitting them to its descendants. In a word the cereals breed true, and the grower may always rely upon his crop being true to the seed from which it was produced.

It is also noticeable that there are minute variations in individual grains, and that no two are precisely alike, any more than are any two blades of grass. There are also sudden and inexplicable departures from the usual type, which attract attention. These might escape the notice of an ordinary observer, but are discerned by the trained eye, so that new varieties have often been obtained by collecting ears of remarkable size, or peculiar character, out of a standing crop; and the curious thing is that these exceptional ears transmit their peculiarities to their descendants. Such was the origin of the potato oat, the chevalier barley, sheriff's bearded wheat, hunter's wheat, and many others long before the idea of cross-breeding was entertained.

Species and Varieties.—The boundary between species and varieties is very difficult to define, and may be imaginary. The gradation from species to species is so imperceptible when specimens are placed in a series as to disappear, and so it is with cereals. There are, however, wider or more pronounced variations, and these are capable of being propagated. They are often the result of climate, as in the hard wheats of Manitoba, or they may be the result of habit of growth, as in the case of winter and spring wheats, but they exist, and remain fairly permanent. There are also species of all the cereals as well as varieties, such as *Triticum sativum* (ordinary wheat), *T. durum* (hard wheat), *T. turgidum* (cone wheat), *T. Polonicum* (Polish wheat), *T. amyleum* (starchy wheat), *T. spelta* (spelt), and *T. monococcum* or one-chested wheat. Barley possesses three species, two-rowed, four-rowed, and six-rowed, all specifically named, and oats are principally classified by the shape of the panicle.



It is not necessary to treat of these species exhaustively, but their origin is shrouded in obscurity. The cereals have been known and cultivated for thousands of years, and the most probable theory is that they originally existed as grasses, possessing certain properties which induced our remote ancestors to gather them, and later to cultivate them. Their very removal from a wild condition into cultivated ground would tend to produce varieties, and selection would in time cause increase in size, weight, and nutrient qualities. The history of the cereals has probably been one of assisted evolution, but the presence of wheat and barley in the lake dwellings of Switzerland is enough to show their great antiquity in their present state of development.

The direction in which all or any of the cereals may be induced to vary are very numerous, and give a good idea as to the differences between most of the varieties in cultivation. Thus, from the root to the awn which rises from the top of the chaff scales there may be

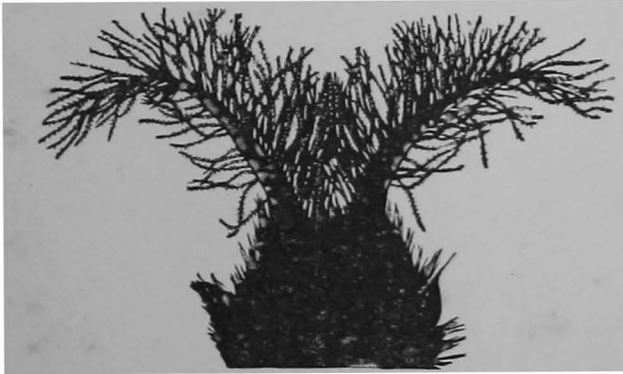

FIG. 25.—The Organs of Wheat.

departures from the type sown, and, as already remarked, these differences are sufficient to become the foundation of a new *sort*. The following synopsis will enable the reader to see how different kinds of wheat may have originated.

#### *Synopsis of Varieties of Wheat and other Cereals.*

The roots may be more or less deep and strong.

The ability to stand severe cold may be developed by habit.

The young plant may be erect as in Talavera, or creep over the surface as in "Creeping red".

The straw may be long or short.

The foliage may be wide or narrow.

The ear may be compressed as in "thick-set", or provided with wide internodes as in Talavera.

The chaff scales may be smooth, rough, red, brown, or white.

The grain may be red, white, brown, small, large, long, short, humped, soft, or hard.

Oats may carry a one-sided, or a round panicle.

Barley may be long-stawed, short-stawed, long, and narrow-eared, broad- and short-eared, or varied in other ways.

The above differences are often expressed by the name, such as rough chaffed red, or rough chaffed white; bearded red or bearded white, stiff-straw, golden drop, Lincoln red, pearl wheat, etc.

Wheat, barley, oats, and rye represent the group known as cereals, so called in honour of Ceres the goddess of corn. They have much in common both as to their nature, and the methods used in their cultivation. They are exchangeable in rotation, as it is a matter of indifference as regards the general course of cropping whether wheat, barley, or oats follow roots or clover. There are determining considerations, it is true, but a corn or "white-straw" crop is looked upon as exhausting in its nature whatever its description, and also as tending to the encouragement of weeds. Hence corn crops are considered to be depleting and fouling, and require to be separated from each other by renovating and cleaning crops: hence rotations.



FIG. 26.—Magnified Stigma of Wheat.



FIG. 27.—Fertilization of Wheat, showing pollen grains adhering to stigma.

The reasons why cereal crops are detrimental to the "condition" of land are well known, but require to be clearly stated. In the first place they make a considerable demand upon the available nitrogen and mineral food in the soil, but they are also accused of being nitrogen wasters as well as nitrogen consumers. They accomplish their growth practically in the spring, i.e. they attain fullest development before or about midsummer. They in fact call for their nitrogen during the spring, when the nitrifying bacteria have scarcely regained activity, and after a large amount of nitrates have been washed through the soil by the winter's rainfall. Arable land is never weaker in nitrates than in spring, and nitrification proceeds most rapidly at the time when cereal crops are ripening. The maximum nitrogen content of a cereal crop is achieved during its period of inflorescence or blooming, as is the case with all flowering plants;

and the subsequent changes which take place are carried on within the body of the plant. In this particular, cereal crops are not exceptional, but in our latitude they operate early in the season; and the main production of nitrates in the soil occurs after the cereal crops have ceased to need them. The practice of early cutting is based upon the migration of nitrogenous and phosphatic matter from the leaves and stems to the head and seeds, and etiolation or blanching of the straw is the necessary consequence.

It is an error to suppose that the exhaustion of a soil is due to the ripening of the crop. The fact is that any crop when in full flower contains the maximum of nutrient matter derived from the soil and the air; and corn crops, if cut and removed in full flower, would carry away as much nutrient matter, scattered throughout their stems and foliage, as if allowed to mature and ripen. It is the same with hay and clover. That severance at too early a stage affects the size of the grain

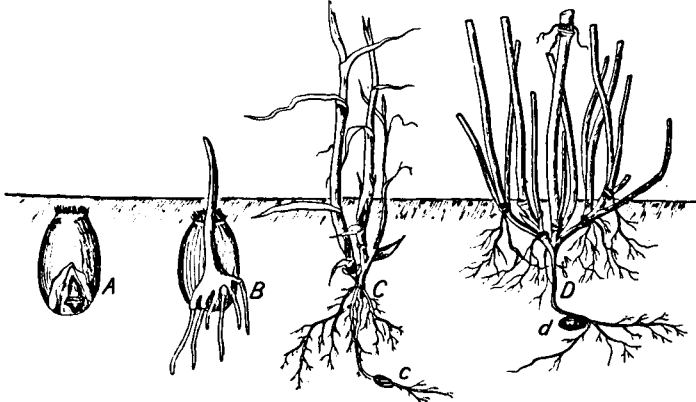

FIG. 28.—A, wheat grain. B, early stage of germination. C, later stage of germination; c, shrivelled seed. D, fully developed plant, showing tillering of roots; d, shrivelled seed.

is no argument against this view, for severance separates the rest of the plant from the roots and stubble, and affects the movements of the sap. It causes the tissues to dry up, and thus interrupts the migration, but does not affect the total amount of nutrient matter collected in the *corpus* of the plant. According to the best scientific authorities cereal crops, especially, draw upon the soil-nitrogen when it is at its *minimum*, and cease to need it after midsummer and in autumn, when it is at its *maximum*. There is a striking difference in this respect between corn and root crops. It shows why top-dressings of nitrate of soda produce such striking effects when applied to young corn in the spring, and why they often are ineffective when applied to roots later in the year. It also explains why folding by sheep, consuming nitrogenous food in the winter, previous to the sowing of spring corn, is beneficial to all cereals.

So far as waste of nitrates is concerned, the mere fact that corn crops are removed when the process of nitrification is at its height shows that the bacterial action is to a great extent too late for these crops. A bare stubble, especially if left unsown through the winter, loses much of its nitrates through rainfall, and hence the accusation that corn crops are nitrogen wasters.

An exception may, however, be made in favour of autumn-sown corn, for the seeds of these crops germinate at a time when the land is well stocked with nitrates. The plants tiller out freely as shown in Fig. 28, and the ramification of root fibres through the soil checks the loss of nitrogen whenever the temperature is sufficiently high to allow of growth. The same reasoning applies to autumn-sown fodder or catch crops, as they, like young wheat, are nitrogen collectors, and this is one of the best reasons for providing a carpet of green as soon after harvest as possible upon all arable fields. The waste of nitrogen, inseparable from the exclusive cultivation of corn crops, is therefore established upon scientific grounds, but, as just shown, it does not follow that in practice this waste constitutes an objection to corn cultivation, if carried out upon enlightened principles.

Another reason why corn crops are exhausting is, that the grain is sold off the farm. This is met by the restoration of the lost materials by the importation of feeding stuffs and extraneous manures, and is mentioned in order to show the importance of liberal management, as a set-off against the sale of fertilizing constituents from the soil.

**Corn Crops tend to make land foul.**—That land which is made to carry corn crops in uninterrupted succession becomes both poor and foul is well known and unavoidable, unless special precautions are taken.

It becomes poor on account of the removal of plant food and the waste of soluble nitrates. It becomes foul, because of the difficulty of hoeing corn crops, and also because couch grass and other stoloniferous weeds are undisturbed during the growth of the crop. There is also a good deal of seeding of charlock, red poppy, and a vast number of annual weeds, docks, convolvulus or lily root, and thistles, so that successive corn cultivation is almost certain to produce foulness in land.

**Continuous Corn-growing.**—In spite of the above difficulties there have been many attempts to grow wheat continuously with a view to profit. This has been done with success so far as keeping up fertility and cleanliness are concerned; but it is doubtful if the system can be made profitable. The following objections are extremely cogent, and are not nullified by any results as yet obtained. In the first place the tendency of continuous wheat (or corn) growing is to eliminate live stock, and this is a very serious matter. It is quite conceivable that this objection might be overruled in certain cases, but not in general, and live stock must continue to be fully as important as corn for generations to come.

Another objection to continuous corn-growing is its unreasonableness, for corn crops show a preference for certain kinds of plant

food, the stock of which they exhaust. Their root system also obliges them to seek for their food in certain zones, or sections of soil, and in a particular manner; whereas other species of plants seek their food in a different manner, at different depths, and at different seasons of the year. Land may become exhausted for corn, while still fertile for other crops, and hence a change would suggest itself as necessary, in order to realize the accumulated wealth in the soil.

The advantages of a change in cropping is demonstrated in all rotations, but also by the luxuriance of mixed crops. A first crop of potatoes is often far superior to any subsequent crop, and after land has been under wheat for several years a crop of potatoes, of mangel-wurzel, of clover, or of some other crop would probably be found to be particularly successful. Hence continuous wheat-growing would break down, and some form of rotation would take its place.

Health of Crops repeatedly taken on the same land.—Cereal crops do not appear to suffer from repeated growth to anything like the same extent as turnips, clover, sainfoin, and some others. Wheat is particularly exempt, and the Rothamsted experiments show that all the cereals may be grown for many years in succession without deteriorating in constitution. Oats are, however, alleged to suffer from too frequent growth, and it is always possible that frit-fly, eel-worm, wheat midge, ear cockle, and other pests or germs might increase under constant cultivation of the crops which they infest. It is wonderful to notice how cereal crops can be cultivated year after year on the same land, and still preserve their health. So much is this the case that it has been asserted that all that is necessary is to feed the crops and cultivate the land, in order to secure an endless succession of cereal crops. The possibility need not be disputed, but the advisability is a different matter, and even when the possibility is granted there still remains the evident advantage of a variety of crops.

Wheat is undoubtedly the leading cereal, and may be taken as typical of the group, all of which are true grasses. How they originated or from what wild prototype they are descended no one knows; but they are products of cultivation as surely as they are still capable of improvement.

The peculiarity of wheat is its exotic character, it being less adapted for our climate than either oats or barley. English wheat is less perfect in its development than that grown in Italy, the Danubian Provinces, Southern Russia, or Canada. It is softer and less glutinous than the fine wheats of Hungary, and has long been chiefly used by millers for mixing with foreign corn. This is not the case with English barley, and as for oats the best qualities are produced in Scotland. The chief English wheat area occurs in the south-eastern counties, where the climate is dry, and there is a maximum amount of bright sunshine. Wheat thrives best in hot and dry summers, such as 1868, 1898, and 1911, which seldom visit us, and there is an observable correspondence between our bumper wheat crops and the vintage years of Europe. After the blooming period has passed, wheat needs no rain, and rarely suffers from heat—hence the old saying that drought never brought dearth to England.

Wheat also requires higher-conditioned land than either oats or barley, and its cultivation is reserved for fields rich enough for the purpose. It also needs more time for full development, and does best when sown in the autumn. It is on these grounds that wheat has been spoken of as an exotic.

Wheat occupies a larger number of positions in rotations than any other crop. It is also planted over a greater number of months. With respect to the first point it is taken after bare-fallows almost universally; also after roots, potatoes, clover, beans, mustard, rape, and cabbage. It has been known to be sown in August, and the first week in September is a favourite date with clay-land farmers. It is sown both before and after Michaelmas, during October, November, and December, in January, and, as spring wheat, in February, March, and April. It has even been sown with success in May, so that only two months are entirely barred against its seeding.

As to the best time for sowing, it is variously fixed; as in September after bare-fallowing, and in October and November after root crops or clover-lairs. Spring-sown wheat is less commonly grown, chiefly because better results are obtainable from oats and barley, but when prices are high a larger breadth may be sown in spring.

The Cultivation of Wheat is as a rule simple. Thus, after roots, the land is ploughed about 4 inches deep, well dressed with the harrows, drilled, and once harrowed. It must, however, be remembered that the land has undergone a thorough course of tillage and cleaning for the root crop, which precedes the wheat. The intricate and expensive cultivation of bare-fallows in these respects resembles that for roots, so that although the immediate sowing of the crop is simple, the preparation of the ground is complicated and often involves deep cultivation. When taken after clover, a single ploughing is usually all that is given, although in some cases the lair is broken up early, and worked as a half-fallow.

Wheat requires a firm substratum, and in the case of clover or mixed seeds this is best obtained by early ploughing, closely followed by a Croskill or heavy Cambridge rolling. The two- or three-wheeled presser is also largely used in many localities to follow the plough before broadcasting. In some instances the land after ploughing is allowed to settle and lie for several weeks, after which it is harrowed eight or nine times in order to secure a well-pulverized bed, and the seed is then drilled and once harrowed. Time is necessary to secure the death and decay of the clover root, and a second ploughing, unless followed by a long series of tillage operations, would bring the roots to the surface and possibly entail carting them off. Wheat is rarely taken after "seeds" in the North of England or Scotland, oats being preferred. It is chiefly a matter of climate and convenience, and there are many reasons (as, for example, the lateness of harvest) which interfere with early wheat-sowing in the north.

Wheat after beans is usually preceded by dunging the land, and, as already explained, wheat and beans succeed each other extremely well. Peas are not so well adapted as beans as a preparation for wheat, neither are vetches, as they both leave the land too hollow.

As to the quantity of seed, it varies with the land, the time of year, and the variety sown, and the smallest amounts are employed on good land in high condition, early in the season. In such circumstances  $1\frac{1}{2}$  bushels per acre is ample, but in October and November  $2\frac{1}{2}$  to 3 bushels is usually necessary. Spring wheat may require 4 bushels, as tillering should not be encouraged late in the season.

Wheat is better for being well manured. Bare-fallows always receive a dressing of farm-yard manure, and so also in many cases does clover land, and, as to wheat after any description of root crop, it also is assisted by previous dressings of dung and artificial fertilizers, and has also often received the residues of purchased food consumed during folding. A top dressing of  $1\frac{1}{2}$  cwt. of nitrate of soda in March or April is always beneficial, unless the land is in high condition, and the crop is sufficiently strong without it. A dressing of 3 to 4 cwt. of superphosphate per acre applied to a lea-land will be found more convenient, and in some cases more effective, than dung. The superphosphate is well harrowed in at the time of sowing, and this course is highly recommended.

The after-cultivation of wheat mostly consists in spring harrowing and rolling, both of which are important. They freshen the surface, destroy multitudes of annual weeds, and press down the soil around the roots after the upheaving effects of repeated frosts. Hoeing is also recommended, but is less generally practised than formerly on account of the higher cost of labour, and the low price of wheat for many years past.

Harvesting Cereals.—To avoid repetition, the main differences in the harvesting of wheat, barley, and oats may be considered here. In the first place the fact that, after flowering, plants are practically independent of the soil, and feed on their own resources, bears on all the cereals alike. Still, it is unreasonable to hold that severance from the root does not affect the circulation or ascent of the sap to the ear. That circulation continues after blooming is indicated by the general belief of farmers that a timely rain during ripening helps to fill the heads. There is also an increase of lime in the ash and probably of silica, and an accession of moisture cannot but facilitate internal movements.

The functions of the roots do not stop suddenly, but cutting must cause an instantaneous stoppage of all communication with the soil. Hence it is possible to cut wheat too soon, in spite of what is sometimes alleged by good farmers and urged by millers to the contrary. That movement continues to take place within the plant after cutting is certain, and this accounts for corn "feeding from the straw". It is even contended that the process is continued in the rick. The effect of cutting wheat raw or "green" is to produce a thin skin, which is in a degree translucent, and gives a horny appearance to the grain, which millers call "strength". It seems to be associated with a high percentage of gluten, but this is in a measure due to a lower starch content, and does not necessarily mean a larger total quantity of gluten. The bushel weighs heavier, and yields a larger proportion of flour and less bran.

The verdict has long been given in favour of early cutting, and the best stage to sever the crop is when the straw is still tinged with green, and the grain is of cheesy consistency, but not fluid.

Barley is required for brewing, and, in order to obtain uniform germination and the maximum amount of starch, it is allowed to ripen more completely than wheat. If, however, it is intended for grinding it may be cut sooner, but the object of the grower is if possible to obtain a malting sample, and the consequence is that barley harvest is delayed until the straw is dead ripe, the ears bend down, and the grain hard and wrinkled owing to drying in, or contraction.

An ideal sample of barley ought to be slightly wrinkled rather than smooth-skinned, short and round rather than long, bright and of pale yellow or straw colour, free from purple stains at the straw end, show no signs of weathering, either by being of dark colour or bleached, without broken or sprouted grains, sweet to the nose and palate. It should handle without conveying any idea of dampness or want of condition, and should weigh 56 lb. per bushel.

Oats may be treated on the same principle as wheat. Oat straw is an excellent fodder, and all straw is better for feeding purposes if cut rather green. The reason for this is that more nutrient matter is retained in prematurely cut than in fully ripe straw, and this alone shows that cutting too early must entail a sacrifice of grain for the sake of straw. The superiority of early cut straw is also due to its containing a larger proportion of soluble cellulose, which changes to woody fibre during the final stages of ripening. Oats are largely consumed upon the farm, and if this is the intention there is much to be said in favour of converting the crop into oat hay by cutting it after it has bloomed, and stacking it for fodder. Theoretically there is no loss, as the sum of the nutrient matter is disseminated through the stems and leaves, as in a hay crop in its prime. Financially the method may be less advantageous, as conversion into fodder, and feeding to live stock may mean profit deferred for too long a time, and a sacrifice of good prices for a fine sample of oats.

Comparison of the three Cereals for Profit.—The three cereals are wonderfully equal as regards value per acre. Wheat is more reliable in price, and more easily quotable than either of the others. Barley is very dependent upon quality, and oats vary as to yield more than either. In some districts oats are considered to yield 2 to 1 by measure in comparison with wheat, but this is a rough and ready statement more true locally than generally.

On light soils under good cultivation 8 quarters of oats may be produced for 8 sacks of wheat, and when this is the case oat cultivation must be highly profitable.

The prices of the two grains may be approximately taken as 4s. per bushel for wheat and 2s. 6d. for oats, and on this assumption it would require 48 bushels of oats to balance 30 of wheat, which would be on the whole favourable to oats, as they would probably yield above this estimate.

Barley depends so much upon quality that its cultivation is attended with considerable risk. Its price usually varies from 42s. down to 24s. per quarter, and the crop is liable to injury from the time of



sowing to its delivery after it is sold. Of late years many farmers have shown a preference for oats on account of the uncertainty of barley; and, as regards yield, wheat and barley are fairly equal, ranging from 30 to 60 bushels per acre. As to the comparative expenses of the three cereals, they are highest for wheat, as is indicated by the practice of taking a crop of barley or of oats after wheat, when the land is partly depleted.

Wheat demands high condition in land, as is shown by its being always chosen to follow a bare fallow. Land may readily be made "too good" for barley, and when this is the case the sample suffers in quality. Oats are greedy feeders, and when liberally treated are capable of yielding far in excess of the 8 quarters above mentioned. They have been known to produce 15 quarters per acre under ordinary good farming, or with the same treatment as would be bestowed upon wheat. It therefore appears that there is no particular inducement at present for British farmers to cultivate wheat to the exclusion of either oats or barley, and that the choice must depend upon the character and condition of the land, rather than upon philanthropic ideas of feeding the nation.

**Barley Cultivation.**—Barley follows roots, according to the four-course rotation, on all the lighter classes of land. It harmonizes well with sheep farming and turnip cultivation, and hence farmers speak of sheep and barley, or turnip and barley, soils. It succeeds best on land in moderate condition, which suggests stripping good crops of turnips so as to leave about ten drills of roots, alternated with bared soil. This shortens the period of folding, lessens the amount of cake and corn fed on the land, and saves the crop from "lodging" before cutting, and thus secures a plumper and better-coloured sample. When land is too rich for barley it is better to sow it with oats. The cultivation of barley consists in ploughing the sheep-folds about 4 in. deep; finely working down the soil, and drilling the seed in rows 8 in. apart, at the rate of from 2 to 4 bushels per acre, according to the date of sowing and the nature of the land. There are, however, many precautions and variations, according to circumstances, each of which deserves notice.

1. As to ploughing, one furrow is sufficient in a large number of cases, followed by dressing and drilling, with as little delay as possible. Land should be ploughed up closely behind the sheep to prevent washing by rain, which may cause the furrows to settle, and necessitate a second ploughing at a later date. A second ploughing should be given in the same direction as the first, to avoid cross-cutting, and bringing clods to the surface. This is called "running back", and leaves a more level surface than cross-ploughing.

2. The season for sowing includes January, and in favoured situations may extend back to December. March is the typical barley-sowing month, and the crop may be sown throughout April and even into May. On the other hand, it can be sown earlier as already mentioned, the precise period depending upon the character of the season and the land. On the whole early sowing is to be preferred, as spring droughts are thus avoided, which interfere with the production of a fine tilth, and cause irregular germination.

3. A uniform and fine tilth is an important factor, and in order to obtain it the land selected should be naturally friable and suitable for the crop. The following points are also important :—



FIG. 29.—Spikelets of Barley, showing improvement effected by breeding.

- (1) Avoid "poaching" the land, in wet weather, by removing the sheep on to a dryer layer for a short time.
- (2) Plough up close behind the sheep so as to secure the mellowing effects of frost and changes of temperature.

- (3) Move the hurdles and troughs regularly in order to secure uniformity both in treading and manuring.
  - (4) In dry weather roll the ground immediately after it is ploughed.
  - (5) On no account allow the clods to dry before rolling, and well harrowing the ground. The chain harrow is a valuable implement for this purpose.
4. The seed ought to be sound, good of its kind, pure, and suitable for the situation.
  5. A single stroke of the harrow followed by rolling is all that is necessary after drilling.
  6. Barley should be allowed to become thoroughly ripe before it is cut.
  7. It is on the whole better tied up in sheaves than carted loose.
  8. A luxuriant undergrowth of clover is sometimes found a difficulty, especially when the crop is bound into sheaves.
  9. Great care is required in harvesting barley to prevent its heating in the rick; and to avoid staining from bad weather, and waste.
  10. The grains must not be bruised or broken in threshing or be over-hummelled, and must be carefully winnowed, screened, turned, and well looked after on the barn floor.

Neglect of any one of these points may be fatal to success, but whatever pains are taken, the season is, after all, the principal factor. Night frosts sometimes cause barley to go off in appearance on the eve of cutting, and a wet harvest frustrates every effort of the grower.

**Barley after Wheat.**—Reference to this method of cropping will be found elsewhere. The conditions conduce to the production of good quality, as the land is not too high in condition, and the system favours a fine tilth and early sowing. Wheat stubbles are easily cleaned in early autumn, and the land can be ploughed in time to benefit from the winter frosts. It also evidently lies ready for drilling on the first seasonable opportunity, so that some of the most important rules for successful cultivation are easily observed. Such crops will benefit from a top-dressing of  $1\frac{1}{2}$  cwt. of nitrate of soda mixed with  $1\frac{1}{2}$  to 3 cwt. of common salt, or 3 cwt. of superphosphate.

**Oat Cultivation.**—Oat cultivation is less critical than that of barley, as the plant thrives in seasons which are too cold and wet for either wheat or barley. It is particularly suitable for northern districts and Scotland, which has produced some of the best-known varieties.

The Northumberland rotation is especially arranged for oats, and is a five-field course in which the position of oats and wheat is reversed. It runs as follows: roots, wheat, clover and grass seeds, second year seeds, oats. This arrangement is probably, or partially, due to the greater difficulty of forwarding the decay of clover root in the colder climate of the north.

Oats are also taken after roots fed upon the land where the soil is not suitable for barley. They are also made to follow wheat instead of barley in similar circumstances. The cultivation of oats, like that of all cereals, is simple in itself, and there are fewer pitfalls awaiting the grower than in the case of barley. They are, however, subject to certain attacks, several of which may be avoided with care.

They should not, for example, be grown too frequently upon the same land, and once in four years is frequent enough. A change of seed is also found necessary, and the kind of oat should be judiciously chosen. Tartarians (black or white) are most suitable for poor land and high-lying fields, and short oats such as the "Potato" and its derivatives can only be successfully grown on good land.

*Tulip root or sedging* is a common ailment of oats difficult to account for or remedy. It is due to an eel-worm (*Tylenchus*) (Fig. 30) which infests the ground and enters the root with the sap. It

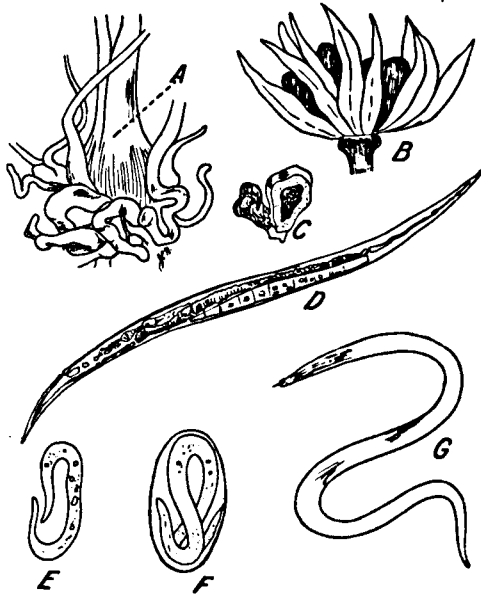

FIG. 30.—Eel-worms. *A*, oat plant infested with eel-worms, causing distorted growth known as "tulip root"; *B*, spikelet of wheat with galls (ear cockles); *C*, galls detached from spikelet, one in section showing wormlets; *D*, stem eel-worm (female), *Tylenchus devastatrix*; *E*, wormlet just escaping from egg; *F*, wormlet in egg; *G*, female eel-worm (*Tylenchus tritici*) causing "ear cockles".

produces a bulbous and distorted root, and causes the foliage to assume the stunted sedge-like appearance, from which the disease derives its name. It affects the finer classes of oats, and may therefore be attributed to growing the wrong sort. Land which shows a disposition to develop tulip root is better sown with some other crop.

*Frit-fly* has been prevalent of late years, and seems to attack late sown oats more virulently than early sown ones. The best precaution is undoubtedly early sowing.

*Gout-fly* is another enemy of both oats and barley. Its maggots distort and convolute the root, and arrest the upward axis in its development. Any of these attacks may be partially recovered from in favourable seasons, but they always leave traces behind in patchy crops, uneven straw, and diminishing yield. It is much to be regretted that up to the present time entomologists have been more successful in tracing the life history of our insect pests and nematode worms than in prescribing practical remedies. The farmer relies more upon judicious choice of varieties, upon good cultivation, and "luck" as to seasons, than upon drastic and often expensive methods of coping with these enemies. The recommendations of entomologists are too often inconsistent with the routine of the farm, and the attacks are too spasmodic as to time and season to warrant extensive preparations for what may not occur.

Oat cultivation is most characteristic when the crop follows grass or "seeds". Lea-land is the theatre of all ploughing matches. The furrows can be faultlessly turned by means of a perfectly graduated mould-board. They are laid at the angle of perfection, 45°, and are so packed or laid, as to form uniform seams for the reception of the seed. They are often slightly crested by tilting the wing of the share slightly upwards, and the work must be perfectly level, and free from openings between the furrows. The slices must also be free from cracks and resemble deal boards laid at the proper angle, and the amount of soil exposed on either side of the crest of the furrow should be exactly equal on both sides. Such is prize ploughing, once described by an old ploughman as "like Bible leaves". This class of work is best performed in winter, and the land is left untouched till March, when it broadcasted with 3 or 4 bushels of seed per acre, and harrowed eight or nine times—lengthways, across, and diagonally.

When oats follow roots fed on the ground by sheep the land is simply ploughed, dressed and drilled, as in the case of barley, but a fine tilth is less important, as oats are more strongly rooted than barley, and uniform quality in the grain is not so much insisted upon.

The quantity of seed varies more in oats than in any other corn crop, and sometimes exceeds moderation. Pedigree oats may be sown thinly, on account of their vitality, and 2 bushels may suffice on good land, early in the season. Ordinary seed is sown at the rate of 3 to 4 bushels per acre, and, on very poor land 5 bushels may be sown. Instances of even larger amounts of seed have been recorded, but seem unreasonable.

*Winter oats* will be again noticed under the head of fodder crops, but they are also grown for seed and consumption in stables. They are sown in October, and are ready for harvesting in July. They are therefore among the earliest grain crops to ripen. They are of dun or black colour, and bloom on a spreading bell or panicle. They yield less abundantly than Tartars, and 60 bushels per acre is a good crop. The straw of winter oats is wiry and inferior for fodder, and is of small value except as litter. The crop is, however, popular on account of its earliness and its consequent high price as horse-corn.

*Rye* is mostly grown for green fodder, but is also harvested for seed. The cultivation is similar to that of winter oats, and the plant

does well on light sandy soils. It is occasionally mixed with wheat, producing what is known in the north of England as "maslin".

**Importance of Condition.**—To secure corn crops in good condition is a main object of the grower. All of them should be harvested dry; but wheat, on account of its open and smooth straw, may be carted during showers which would stop barley carting. Oats being largely used for home consumption are often thought less important than wheat. Beans are proverbially credited with powers of resisting wet weather. Barley is undoubtedly the most difficult corn crop to harvest, as it is easily discoloured or stained. Being cut when quite ripe it may often be taken up immediately after cutting. In this case a reaper, or even mowing by hand, may be preferable to the use of the binder. Few things in farming call for the exercise of a sounder judgment than the conduct of harvest operations. They should be carried out with promptitude, but without panic, and it should never be forgotten that corn may spoil in the rick as well as in the field. In difficult harvest weather corn is better left standing than cut when wet, and of all things tying up sheaves in a wet state is to be avoided. A standing corn crop will dry in half an hour, but a wet sheaf will never dry, unless it is opened and laid in broad-band.

## CHAPTER VIII.

### ROOT CROPS.

REFERENCE to the section on rotations will show that root crops are here looked upon as the beginning of each course of cropping. They are properly considered as "fallowing crops", and may be relinquished in certain cases in favour of a naked or summer fallow. They are a great improvement upon the bare fallow, excepting when the land is too stubborn to work down into the requisite fine tilth necessary for the successful germination of turnip seed. Root cultivation is associated with barley husbandry, while bare fallows suggest autumn-sown wheat. Roots are definitely an obstacle to early wheat-sowing, while bare-fallowing favours it. Besides this, land which may require bare-fallowing is eminently suitable for wheat, and hence the two are associated, just as are roots and barley on lighter soils.

Clay lands are not adapted for winter folding, nor yet for carting off heavy crops, and it is quite possible that one result of root cultivation on stiff clays may be a lessened grain crop. It is worthy of remark that bare-fallowing continues to survive in England, in spite of much that has been written against it. There are, in fact, no less than some 340,000 acres of land devoted to it in England, but only about 6,000 in Scotland; and this is to be partly accounted for by the larger area of wheat produced in England, and the strong nature of the land lying upon the great clay beds of the Weald, Oolite, and Lias formations. The extended cultivation of summer fodder crops, such as rape, cabbage, and kale, to a great extent relieves the necessity of summer fallowing, but there is a thoroughness in the bare fallow which commends it to many good farmers. It is also excellent as a means of cleaning land which cannot be successfully worked in spring.

It is scarcely to be expected that in a work of this nature the practice of summer fallowing should be advocated. Its complete abandonment would seem more in accordance with the reformation of our somewhat sluggish systems of cultivation, but there are cases in which, owing to unfavourable seasons or foulness of the land, there is no alternative. There is, however, room for the extension of fodder crops for consumption during the dry months of the year, among which, besides those already mentioned, are vetches. These do not interfere with early wheat-sowing, and might be more generally grown.

There is another aspect of summer fallowing which no doubt affects practice, namely, the smaller capital involved per acre. Thus, when a three-field course, or a modification of it, is adopted, one-third of the arable land is in bare fallow, and this entails less capital than root cultivation, and the consequent maintenance of a large head of live stock. This appeals to poor farmers rather than to rich men, and can only be looked upon as a lame argument.

**Why Root Crops take the place of Bare-fallows.**—1. Root crops are for the most part sown in summer. It is true that mangel-wurzel is drilled in April, but it is the earliest of the group. Even early rape and turnips are seldom sown till May, and the main crop of swedes and turnips in the south are not put in till May, June, or July. The interval for cleaning and preparing the land for root crops therefore extends from harvest of one year to the following summer, and this affords ample opportunities for fallowing.

2. Root crops are drilled in rows of from 18 to 30 inches apart, which allows of both horse and hand hoeing for many weeks after planting.

3. They require liberal manuring, and are consumed upon the holding, and therefore leave the land in good condition for a succession of crops.

4. They are supplemented with hay, fodder, and purchased foods, either supplied to sheep on the land or to cattle in yards, and hence they greatly increase the fertility of the land.

5. They constitute an important set-off against the expenses of fallowing; for, although they may be grown at an immediate loss, the net result is a cheap preparation for future crops.

These advantages are most apparent upon light classes of land, and become less evident on stronger clays, until they cease to count on sour and wet soils, which are better worked during the summer as bare-fallows.

**Potatoes.**—The position of potatoes is somewhat different from that of root crops. It is not necessary to lay stress upon the fact that potatoes are not roots but underground branches furnished with buds (Fig. 31). The same objection might be raised as to kohlrabi, which is a stem and not a root, or to cabbages, which are leafy developments. Even the bulbs of swedes and turnips are better described as cellular enlargements of the downward axis than as true roots, so that to say a potato is not a root scarcely appeals to a farmer. The potato crop ranks as a root crop, so far as preparation of the land and place in rotation are concerned. It occupies a part of the fallow breadth, and if it were consumed by live stock it would be mere pedantry to urge that it is not a "root". The fact that it is sold off the holding separates it most clearly from other root crops, and when roots are sold the anomaly disappears, and the comparison is rather favourable to the potato.

Potato cultivation is a most important feature in British agriculture, there being now some 550,000 acres cultivated in Great Britain every year. Potatoes, however, introduce an intensive cultivation, great liberality in manuring, and an expenditure beyond most crops which do not encroach upon market gardening. They may be



considered as a garden crop, and the minute details of their management as well as the vast number of their varieties suggest special treatment.

#### POTATO CULTIVATION.

The potato can be cultivated on almost any soil, but with varying success, and the heaviest yields are obtained on deep friable loams. On heavy retentive clay soils difficulty is experienced in obtaining a good tilth, and where heavy rains follow immediately after ploughing the soil becomes caked and hardened, thereby preventing the plants from growing freely, and also restricting the formation and growth of the tubers later in the season. Sandy soils, unless deep and moist, are usually too dry to induce healthy development, and

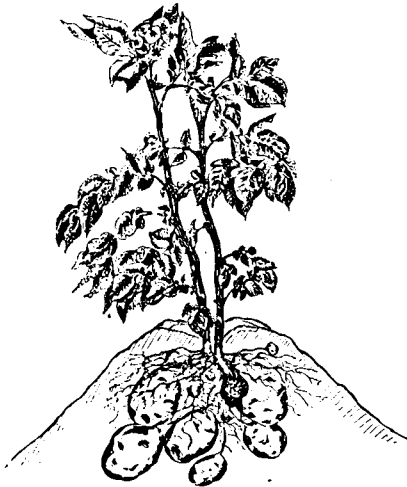

FIG. 31.—Potato Plant, showing production of tubers.

the yields are exceptionally small. In typical potato-growing districts, such as Midlothian and the Fen district of Lincolnshire, it is nothing unusual to obtain a yield of 15 tons and upwards per acre, as compared with 7 tons per acre on some of the heavy soils in the South of England.

**Selection of "Seed".**—Much of the success attending the cultivation of potatoes is dependent upon the careful selection of the "seed". If grown continuously on the same soil and in the same district the constitution of the tubers becomes impaired, and it is for this reason that it is necessary to obtain a change of "seed" at least once every two years. Moreover, it has been demonstrated that fully matured tubers lack vigour and vitality, in all probability due

to the increased formation of starch. Plants grown in the South of England ripen considerably earlier than those grown in the North of England, Scotland, and Ireland, and it is for this reason that Southern growers import Lincolnshire, Scottish, or Irish seed, the skin of which is not so net-veined as that of riper tubers. Many growers of "seed" take up their crop before it is ripe in order to retain as much vitality in the tubers as possible. It has been observed, that where the imported seed is properly harvested and stored, heavier crops are usually forthcoming in the second year of planting.

The ripened "seed" or tuber of the potato is comparable to a malting sample of barley with its abnormal development of starch, which imparts to it a delicacy of constitution not found in feeding samples, which, like the immature potato, contain a greater proportion of nitrogenous constituents, that impart to it increased vigour of growth. The most prominent varieties of potatoes are in time

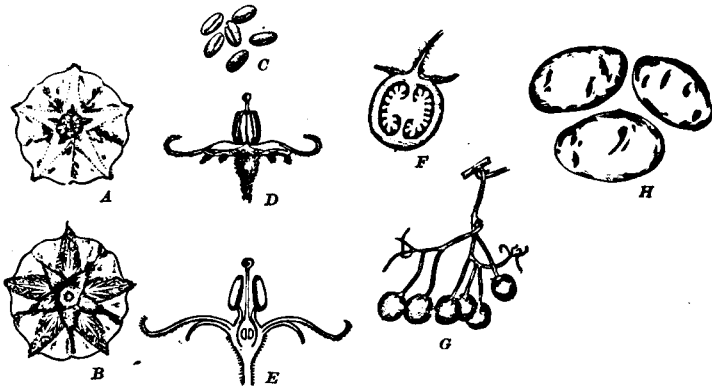

FIG. 32.—The Potato. A, B, D, the flower; C, seed; E, section of flower, showing stamens, ovary, style, and stigma; F, transverse section of ovary; G, fruit; H, tubers.

superseded by newer kinds raised from actual seed, obtained through crossing well-known types, with which is often incorporated some strain of the wild type of *Solanum tuberosum*. The formation of the flower and fruit together with a fully developed plant is shown in Figs. 31 and 32.

Planting.—Many methods of planting are practised. In the North, after autumn ploughing and well working the ground in spring, the furrows are ridged up with the double mould-board plough to a width from 25 to 30 inches, well-decomposed manure being spread in the furrows, and the sets are planted on the manure about 1 foot apart. Sometimes the manure is applied in the autumn, and artificials are often broadcasted on the land before the ridges are split, it being customary on many farms to give a dressing of a mixture of 1 cwt. of sulphate of ammonia and 5 cwt. on superphosphate per acre, while on the lighter soils from 1 to 3 cwt. of kainit are added. After

planting, the ridges are split so as to cover the sets with the manure, and so leave them in the middle of the ridges.

Planting usually commences in March, and is continued throughout April.<sup>1</sup> No definite rules can be laid down as to the method of manuring, or the preparation and kinds of manure to use. In fact, potatoes usually give a maximum yield when they follow a crop cabbage, or other member of the Brassica family, which was heavily manured. In many districts short sets are ploughed in with the ordinary plough, 9 inches wide, planting being performed in every third furrow. This practice, except on well-pulverized soils, is less successful, as a plough pan may be formed, and the plants do not admit of being satisfactorily earthed up.

In market gardens it is sometimes customary to use a steel pointed dibbler, to which a cross-bar is fixed, to keep the tubers at a uniform depth. Dibbling, although entailing much time, is nevertheless highly satisfactory, and is only excelled by digging in, as is done in many kitchen gardens. Where a heavy crop is scarcely to be expected, the sets may be placed as close as 8 inches apart, and 24 inches between the rows, in which case nearly 1 ton of sets per acre will be required, the more usual quantity being from 12 to 14 cwt.

Sets of an average weight of 2½ oz. are found best, and those of larger size should be cut lengthways through the crown, which will admit of equal growth from either portion. When the sets are cut they should be left exposed to the air for a day or so, or dusted over with ashes, gypsum, or lime, to enable the cut surface to heal over and prevent its rotting before the buds are sufficiently developed to form roots.

**After Cultivation.**—After the field is planted and the land is sufficiently dry, a flat roller should be passed over to press the soil firmly round the tubers, and in the course of a fortnight or so, a light harrowing will assist in destroying any weeds that may have germinated, and any crust that may have formed. As soon as the plants are well above ground they should be horse-hoed, and, later, hand-hoed. After each horse-hoeing the ground between, in the rows, should be thrown up against the plants by means of a ridging plough, or a potato plough, the hinder tines of which are removed. The earthing up tends to counteract any tendency of the hoeing to work down the ridges. This alternate horse-hoeing and earthing up can be continued until the haulm is well developed, when the final earthing up should be given, by which time the overhanging foliage will prevent any undergrowth. The maturation of the tubers is generally indicated by a gradual withering of the foliage or haulm, while the skin is found to adhere firmly and not to rub off the tubers.

Numerous experiments have been made as to the value of deep earthing up, and even where little difference has been recorded in the yield, a large proportion of the tubers produced from unearthed plants turn green from exposure to the light, and are thus rendered unfit for consumption.

**Early Potatoes.**—The cultivation of early potatoes is an important industry in many parts of the country, notably in the Channel

<sup>1</sup> For description of potato planter see p. 368.

Islands, Cornwall, Ireland, and as far north as Ayrshire, where large tracts of fertile soil owe their warmth to the influence of the Gulf Stream.

The earlier the crops can be placed on the market the more remunerative they are to the grower ; and to facilitate this object the sets are placed in shallow boxes, or potato trays (Fig. 33), the free ends of the tubers, containing most buds, and known as the "rose-ends", being placed uppermost, in order to admit of short shoots being formed (Fig. 34). The construction of the potato-trays admits of a large number of them being superimposed one on the top of the other, so that a large amount of seed may be stored in a shed or ordinary dimensions. It is important that the air should be kept at a low temperature, but above 32° F. A severe frost would prove fatal, while a close warm atmosphere induces the development of long weak shoots. Light should be freely admitted, otherwise the shoots will become white and blanched, and lack vigour of constitution.

As soon as the land admits of being freely worked, the sets are taken to the field in the trays and planted by hand, care being taken not to damage the shoots. Planting is done somewhat thickly in the

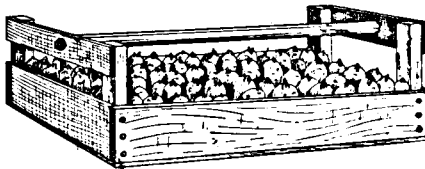

FIG. 33.—Potato tray for storing "seed" potatoes.

rows, but the tubers are placed at a depth of about 6 inches as a protection against frost. Late frosts not infrequently cut back the tops with disastrous results, as some time elapses before the plant can make fresh foliage.

In order to be sufficiently impressed with the importance of this industry, and the intensive nature of the cultivation, the student should if possible visit some of the early potato-growing districts during the time of planting and harvesting the crop. Great care is taken in selecting proper varieties for early use, and among them may be mentioned Sutton's Ringleader, May Queen, Midlothian Early, Rivers' Royal Ashleaf, Sharpe's Victor, Express, and Duke of York. There is also a group known as second earlies, commonly used as early potatoes on soils not suitable for the cultivation of the above varieties. In soils of a naturally heavy, retentive character, the temperature of which is low, second early varieties such as Southern Queen, Radium, Eclipse, Sir S. Llewellyn, Surprise, Snowball, and British Queen will suffice for early use ; but for the main crop the hardier potatoes like Dalhousie, Up-to-date, King Edward VII, Arran Chief, King George, Premier, Sensation, and The Colleen must be grown, or whatever new introduction may surpass those already in cultivation.

**Spraying.**—The wet or dry spraying of potatoes (see Fig. 68) with Bordeaux Mixture has done much to mitigate the loss from disease, in the same way as has the spraying of hops. No grower can afford to neglect this important operation, instructions concerning which are given on p. 177.

**Harvesting.**—Early potatoes are usually lifted by means of hand forks, grading being performed by means of sieves as the work proceeds. The saleable potatoes, or "ware", are weighed if necessary, and then placed in barrels or bags, and consigned to the market direct from the field. The main crop, if grown on a large scale, is usually raised by machinery (see p. 368), or if a farmer has only an acre or so the tubers are generally lifted by a plough, the hand fork being used to complete the operation of bringing the tubers to the surface.



Pit-sprouting Potato.



Box-sprouting Potato.

FIG. 34.

**Cleaning and Grading** may either be performed in the field or in suitable outbuildings, after which the "seed" and "ware" are placed in clamps, as advised in storing other root crops, except that the clamps are smaller in order to prevent overheating. The width of the clamp is about 4 feet, and the height  $3\frac{1}{2}$  feet. If the weather remains open, the heaps are best left open or lightly covered with straw or "muckle" for several weeks in order to allow the surplus heat to escape, after which a good coating of straw should be laid over the tubers, followed by a layer of 7 or 8 inches of soil, according to circumstances. When obtainable, there is no better covering than thick turves of peat moss, in which case no straw is required. A trench dug round the clamp will provide for the necessary drainage, and small drain pipes should be inserted along the ridge of the clamp, as, if confined, the warmth not only induces premature sprouting, but may also cause the rotting of the tubers.

## MANGEL-WURZEL.

Mangel-wurzel, as the earliest sown, deserves a first mention among the regular root crops. It belongs to a natural order which, with the exception of sugar-beet, it alone represents among our farm crops. It is allied to spinach, and to certain agricultural weeds, among which goose-foot may be mentioned as giving the name to the order. This is *Cheopodiaceæ*, widely represented by *C. polyspermum*, *C. album*, and *C. Bonus-Henricus* or Good King Henry. The beets form a genus of this order, and the only British species is *Beta vulgaris*, var. *maritima*, the wild prototype of mangel-wurzel, sugar-beet, and garden beet-root. Most authorities agree in regarding all these plants as cultivated varieties of one species. In Germany, where mangel-wurzel and sugar-beet are both widely cultivated, they are respectively called *futter Rüben* and *sucker Rüben*, and the name mangel-wurzel is merely the German equivalent of scarce root.

*The botanical position* of mangel-wurzel explains certain differences between it and the cruciferous root crops. It is naturally fitted for maritime situations, in which salt is carried inland by the rain and is abundant in the soil. The plant possesses great powers of development. It prefers a strong loamy soil, and requires a fair depth of staple. It is easily injured by frost, but is not subject to so many diseases and insect attacks as cruciferous root crops. Like all cultivated plants it has assumed many forms (Fig. 35) and colours, such as long and globular, red, yellow, and intermediate, adapted for different soils and situations. It is a sugar-producer, but is also a lover of salt, its flavour being affected by both these constituents.

Its roots develop in concentric rings resembling the growth of exogenous trees, and are more easily bruised and wounded than swedes. They are, however, capable of keeping for a longer period, and retain their juiciness and nutritive properties far into the succeeding summer.

*The cultivation of mangel* is based on the above properties. It is generally grown on deep and rich soils<sup>1</sup> in close proximity to buildings from which it can be easily carted and manured. It has for long been a feature of the Lincolnshire Wold farming, as well as of the deeper soils of that county. It may also be grown on the same land year after year for an indefinite period without showing any signs of deterioration, provided it is liberally treated. It is essentially a keeping crop, and although much used for sheep is rarely folded upon land. It is generally sown about the third week in April or early in May, but in sheltered situations it has even been drilled in February. It is subject to injury from frost, and comes away more rapidly when sown comparatively late.

Mangel is a biennial, producing seed in its second season, and if sown too early it may develop flowering stems during its first summer. It carries no conspicuous corolla, but produces spikes of

<sup>1</sup> Mangels are also grown successfully on the richer pockets of soil which occur on the Upper Chalk, often in the neighbourhood of outlying barns where the roots are useful for stock.

green flowers, and the fruit of several of these often form a compact cluster which is known commercially as "seed". These fruits, which

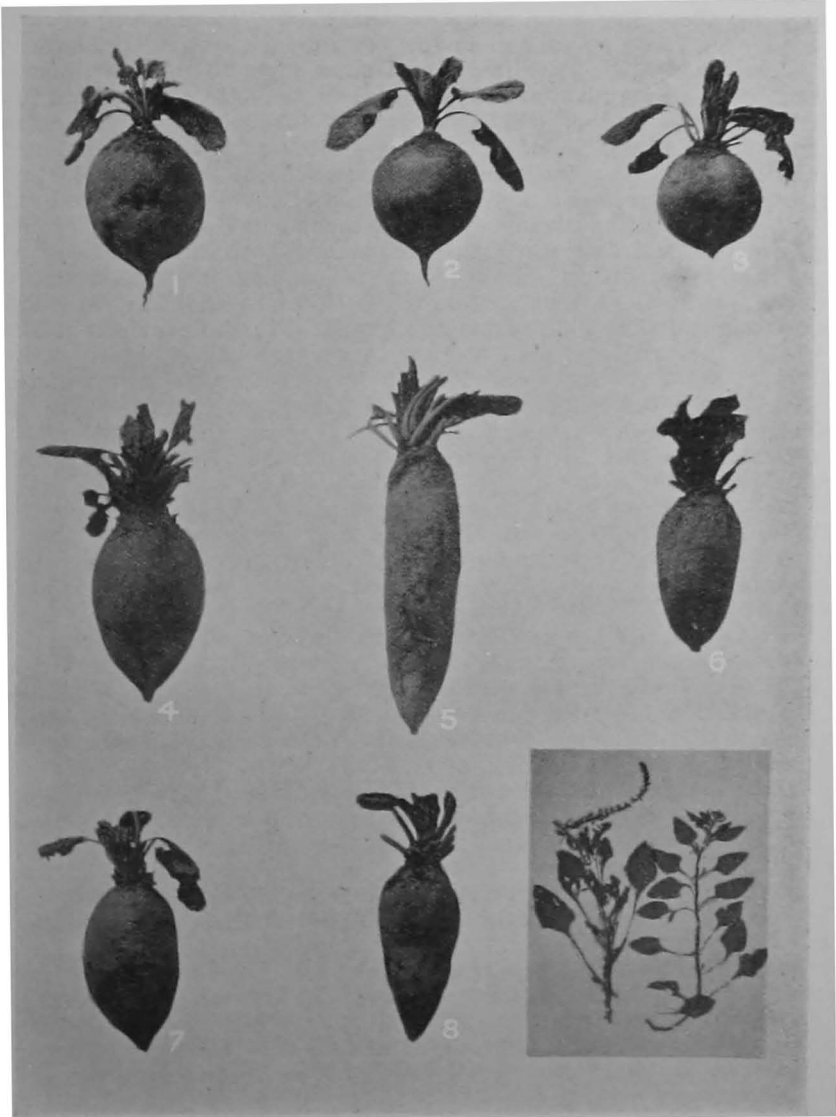

FIG. 35.—Types of Mangel. 1, 2, 3, globe varieties; 4, intermediate; 5, long; 6, tankard; 7, 8, sugar-beets; inset, foliage and inflorescence of mangel.

contain as many as five seeds each, are tough, irregular in form, and of light-buff colour, and are better steeped in warm or cold water

twelve hours before sowing. They are then dried by exposure so as to run easily in the drill, and must not be kept so as to heat.

The requirements of the crop point to autumn cultivation and manuring, deep ploughing, and a seed-bed ready for drilling in April. The tilth need not be so fine as for turnip seed, but should be loose, deep, and rich. The fertilizers used should be nitrogenous, such as good farm-yard manure, nitrate of soda, or sulphate of ammonia; but superphosphate is less effective than it is for cruciferous crops. As the crop is capable of producing from 40 to 70 tons per acre, and is alleged to have reached 100 tons, liberal treatment is to be recommended. Some of the heaviest crops have been produced after dressings of 20 tons of farm-yard manure, and 3 cwt. of nitrate of soda, but in ordinary cases half the amount of dung is sufficient. Prize crops have been produced by the application of dung, with 5 cwt. of kainit and 4 cwt. of super per acre in addition. (See also Common Salt.) The yard manure is ploughed in the previous autumn, or raised into ridges which are split over the dung before winter, and left to mellow under the influence of frost and changes of temperature. They are harrowed down, lengthways, in the spring, and reformed by passing a double mould-board plough between them, and are then drilled and lightly rolled. Five pounds of seed are generally sown per acre.

**After Cultivation.**—Mangels are particularly liable to be smothered by annual weeds. The seed is often slow in germinating, and the young plants closely resemble several other strap-shaped seedlings. The young mangels are easily recognized by their fleshy and coloured roots, but when encroached upon by multitudes of weeds they are difficult to clean, either by hand or horse hoes. The first stages of growth are therefore critical, especially as the plants are subject to the attacks of slugs and beetles. In order to obtain rapid germination, and a quick passage into the second leaf, it is important to secure new seed, and to steep it before sowing; to kill all surface weeds by harrowing, and not to drill too early.

**Moderate-sized Mangel best.**—The size of the roots depends upon the fertility of the land, the amount of manure applied, and the width between the rows and plants. Moderate-sized mangels contain more dry matter than large ones, and it has long been recognized that roots of 7 to 8 lb. each are preferable to those which might possibly reach 30 to 40 lb. The amount of room allowed is therefore important, and on most soils 18 inches, in both directions, is sufficient, and gives room for 19,360 plants per acre. Vacancies, however, always occur, and may spread over many square yards. There are also small roots which come to nothing, so that 15,000 fairly represents the number that may be expected at the above distances. The weight per acre will vary with the average weight of the roots, and is expressed in the following figures:—

An average weight of 7 lb. per root =	47 tons per acre.
“ “ “ 6 “ “	= 40 “ “
“ “ “ 5 “ “	= 33 “ “
“ “ “ 4 “ “	= 27 “ “



**Transplanting Mangels** is possible if rapidly performed during dull, showery weather, but the best results are obtained from undisturbed seedlings. Gaps may be filled by spare plants taken from the rows, and if this be done in damp weather they will strike freely. Transplanting, however, is always uncertain, and on the whole blanks are better filled with cabbage plants, or with a sprinkling of turnip seed, hoed in when vacancies become apparent.

**Importance of Hoeing.**—The remaining cultivations consist in horse and hand hoeings which ought not to be fewer than three of each. Hoeing, in the case of all root crops, is so important that a few remarks upon it may be introduced here, if only to avoid future repetition.

Success in root cultivation depends to a great extent upon hoeing, for if this be neglected neither land, manuring, nor a favourable season can ensure a satisfactory crop. Interculture between the crops should always precede hand-hoeing between the plants in the rows. The first horse-hoeing may be preceded by a light harrowing; and a single row scuffler is preferable on stony or brashy land to those more ambitious implements which take three or more rows at a time.

In narrow drilling, say 15 inches wide, single row hoeing may be thought too expensive, but certainly in wide drilling, of say, 25 inches and upward, the one-row horse hoe is to be preferred. It is thorough, and less liable to slip and obliterate contiguous rows, especially on sloping land, and is capable of doing 4 acres a day in 27 in. drilling.

Singling requires so much care that the practice of letting it by the acre is liable to produce careless work. Some good farmers prefer day labour, even in the South of England, and in Scotland and the North, where swede cultivation is most perfectly carried out, it is almost universal. The objects aimed at in singling are so numerous that they are often forgotten by task-workers. It is important, for instance, that the best plants should be preserved, and yet that regularity should be observed in setting them out. The plants should not be buried under loose soil, nor left too bare, nor two of them together. All annual weeds should be destroyed, and the roots of grassy herbage, or of stubborn thistles and docks, severed. The soil should all be moved between the plants, so as to keep the surface fine and moist by capillarity. Day labourers, and especially women-workers, may be instructed on these points, but not piece-workers, whose main object is to make as much money as they can per day.

The first hoeing, or singling, is done as soon as the plants (be they mangels, swedes, turnips, or rape) have fairly passed into the "rough" or second leaf. They grow rapidly after the operation, and as soon as the leaves are half-way across the drills they should be second horse- and hand-hoed. In this hoeing, all "doubles" should be removed, all weeds cut out, and all the ground moved whether weedy or not. The third hoeing (horse and hand) is given at a later stage, before the workers are shut out by the luxuriance of the plants, and in many cases it is omitted. With mangel, however, the third hoeing is important, as the crop is sown early, and requires constant care during the entire season. The number of hoeings depends a great deal upon the time of sowing, and in the case of July and August sown

turnips singling may suffice ; while in ultra-late sown crops, broadcasting with a barrow may take the place of drilling, and hoeing be dispensed with. As the chief object is good cultivation and a maximum production, it may be further observed that both horse- and hand-hoeing are often carelessly and ruthlessly carried out in many southern counties. The multi-rowed horse-hoe, and piece-work, are to a great extent responsible for this defect, but the frequent result is shabby and irregular crops. It is also partly due to unavoidable late sowing.

**Storing Mangel.**—The mangel crop grows rapidly in September, but seldom after the end of that month. It is best stored in October, but the work often extends into November. It ought to be finished before the advent of severe weather, but if this supervenes, as is often the case, it is better to wait for a return of open weather, and unless there have been more than 10° F. of frost the crop will not suffer.

The roots are pulled by hand, and are best carted at once to the clamp. If left out during the night they should be made into small heaps, and covered with a few leaves as a protection.

The tops are removed by twisting them off by hand, as knives are sometimes used injuriously. Mangels are said to "bleed" when cut or broken, in the same way as garden beet does, and for this reason cutting off the tops may injure the crown of the root. Similarly, mangel should be thrown gently, and from a short distance, into the carts, and the roots or tails should not be removed. A little adhering earth is not a disadvantage, and may assist in keeping the roots fresh. The clamp or heap is placed conveniently for future use, and is better made about 12 feet wide. It is carried up to a point, and forms a prism of any required length.

The heap is covered every day with a layer of offal straw, about 6 inches thick, and is then safe for some weeks. There is no better covering than barley cavings, and when it is covered with earth no frost can enter. Later, and before winter, the straw is covered with an additional thickness of 6 to 9 inches of soil, dug from a trench on either side, and carried up to within a few inches of the apex (Fig. 36). The whole is then covered with a coat of thatch kept in place with spars and tar line. It is desirable to strip off the thatch and layer of earth in March in order to check the sprouting of the roots in spring.

Mangel should always be stored when it is free from frost, and dry, or it may heat and rot in the heap ; and the object of leaving a ridge along the top free from soil is to allow of the escape of watery vapour. Rats often make their home in mangel heaps and grow fat upon the roots. They are difficult to dislodge, and should be prevented from gaining access by pegging down a fence of wire netting supported on stakes around the clamp. In this case the netting should be let down well under the surface of the ground, as in fencing against rabbits.

**Storing Root Crops.**—Swedish turnips are stored in several ways. Being hardier than mangels they only require to be covered with a few inches of straw, weighted sufficiently to keep it in place.

They may be thrown up against a wall, or formed into long prisms like mangel, or made into small heaps, containing about one cartload each, dotted about on rye or winter barley. Or they may be laid in, side by side, along a furrow opened by a plough, and then turned back upon the roots, so as to cover them with soil. When stored for cattle, they are "topped" and sometimes "tailed", but when heaped, or ploughed in for sheep, the tops are left on.

In southern counties, where ewe flocks are kept, swedes are often left *in situ* in the fields, and allowed to throw up green tops in spring for lambs. Their nutrient properties are best preserved by storing, because when left on the ground the flowering stem begins to lengthen, and the nutrient matter in the bulb to ascend. This movement is at once checked by clamping them, and swedes so treated will keep good till the following May. There can be no doubt as to swedes being better pulled and heaped, but the greens are an inducement for letting them stand for lambs in sheep-breeding districts.

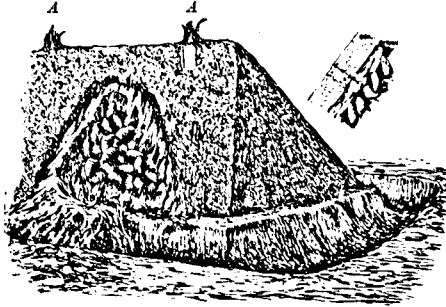

FIG. 36.—End of Mangel Clamp. A, ventilation (wisp of straw or pipe in ridge).

White Turnips are seldom stored, but may be pulled and placed touching each other, with their tops on, in any field corner. The haulm protects them from frost, and they root again to some extent, and are carted to stock in pastures as required. Being of a soft nature white turnips do not keep well in heaps, and are generally consumed on the ground by sheep. They are an excellent introduction to swedes and hard winter feeding.

#### SUGAR-BEET.

Sugar-beet is a variety of *Beta maritima*, included by botanists in the group of garden beet and mangel-wurzel, under the name of *B. vulgaris*. In foliage and inflorescence all these plants closely resemble each other, but the sugar-beet (Fig. 37) is longer and more tapering in its root, white or light-coloured in flesh, and remarkable for the high percentage of sugar it contains. It is very extensively cultivated in all European countries, including Sweden and Denmark, and there is no *a priori* reason why it should not thrive equally well

in Great Britain and Ireland, a view which is supported by numerous experiments and recent practice.

It is therefore unnecessary to quote instances or to educe evidence that sugar-beet can be successfully produced in this country. The conditions of soil and climate are favourable to its development, and the proportion of sugar is satisfactory. The plant does well on all medium loams, and on deep soils free from stones, which cause the roots to divide. Its tap-root penetrates to a great depth, and one of the difficulties consists in the labour required for lifting the crop.

Another point of importance is the comparative value of sugar-beet as contrasted with mangel-wurzel as a stock food, and in this it may be mentioned that 57 lb. of sugar-beet has been found to give as good results in increasing the live weight and satisfying the appetite as 75 lb. of mangel-wurzel. It must, however, be remembered that average yields of sugar-beet are represented by 16 to 19 tons per acre, whereas mangel-wurzel will easily produce double these weights, and is much easier to lift. There is also the difficulty of transit or railway carriage, and in order that sugar-beet cultivation should become successfully established in this country these expenses must be reduced to a minimum. This can only be done by the presence of factories in near proximity to the crops, and a sufficient price per ton to encourage farmers to produce the roots.



FIG. 37.—Typical Sugar-beet.

A move has already been made at Cantley in Norfolk, and there is a scheme on foot for establishing a new factory near King's Lynn. In order to supply a factory it is calculated that from four to five thousand acres of beet would be required, and further guarantee appears to be necessary that this large area will be forthcoming during successive years as well as at the onset. The factory and the cultivator are mutually dependent on each other, and the failure of either would at once arrest further progress. One practical solution of this difficulty would be the purchase of sufficient land by the company for supplying the roots. The enterprise is therefore at present speculative in its nature, but the facts are all in its favour so far as the cultivation of the crop and the manufacture of sugar are concerned. The idea is, however, still regarded as a novelty, although it is more than forty years since it was put into practice on a large scale by Mr. Campbell of Buscat Park, Faringdon. It was then found that the manufacture of neutral spirit was more profitable than that of crystallized sugar, but this venture was closed on account of the recall of foreign workmen at the outbreak of the Franco-German War in 1872, and was not afterwards resumed; the estate was, in fact, sold.

The subject of sugar-beet cultivation has therefore been before the public for many years. It may be regarded as an extremely

important project, which, if carried out, would revolutionize British agriculture, there being no practical limits to its extension. The Excise laws are, of course, a serious obstacle, as they involve a tax which, if inflicted on home producers, would be detrimental to the expansion of the industry.

In the case of factories being started at various centres, the pressed pulp, after the juice has been removed, would be a valuable food for stock, and proximity to the factory would become of double importance in order that the roots may be readily delivered and the pressed pulp be returned to the farm. This "pressling" is largely used by stock feeders on the Continent, and is easily preserved in silos until required.

The following remarks by the present writer were contributed to the *Agricultural Gazette* of April 21, 1913:—

"In growing sugar-beet the rows ought not to be more than 14 inches wide, and the plants should be singled to 8 to 10 inches apart. This is practically one square foot per plant, or 43,560 plants per acre. The roots ought not to weigh more than 1½ lb. when ready to lift, and the weight of a perfectly regular crop at the above distances and weight is 31 tons 8 cwt. per acre. Results show that about half this weight is usually obtained, which indicates that blanks and gaps and failures are an important consideration. It is, however, known to experienced growers that 20 tons can be produced if the cultivation is properly carried out. Raised ridges, with yard manure under the plants, favours the throwing out of side rootlets, which are a principal cause of the difficulty of lifting the crop. One of the commonest mistakes made by English growers is to too closely imitate the ordinary cultivation of the mangel-wurzel, which is so conducted as to develop roots of 7 lb. to 8 lb. each or even more. If growers persist in drilling 25 or 27 inches apart, and setting out the plants to 15 or 18 inches, the number of roots must necessarily be greatly reduced, and the weight per acre also, as sugar-beets will not develop beyond 2 or 3 lb. in weight. Much has yet to be learned by farmers as to the best method of growing this root, but for all that the cultivation is not difficult. It resembles that of parsnips rather than of mangel-wurzel; and a two-pronged lifter, or a specially constructed plough, are the best means of raising sugar-beet."

Another point is stone-free soil, as a large number of flints or pebbles may cause bifurcation, or become fixed in the roots beyond the power of washing them out; and this plays havoc with the machinery. Growers should aim at the production of 2 tons of sugar per acre. The cultivation ought to extend, and no doubt is doing so, but the difficulties are formidable. The first thing is to study the cultivation of the root, and to give some attention to the subject, as of real importance to British agriculturists. The quantity of seed requires clearing up, as some growers are using as much as 20 lb. per acre this season. Of course narrow spaces between rows mean more seed, but as 5 or 6 lb. of mangel seed is found sufficient at 18 inches apart, 10 or 12 lb. seems reasonable for sugar-beet. On the other hand, the seed may be less reliable, and the seed-vessels contain fewer seeds than those of mangel.

## SWEDE CULTIVATION.

The swedish turnip, *Ruta бага*, as it was first called, (*Brassica campestris*), is a comparatively modern introduction. It was first brought to Scotland 1775-80, and soon established itself as a valuable winter food. It is very hardy, but cannot resist our severest winters, and for this reason is always stored in the northern parts of the kingdom. Swedes contain slightly less water than white turnips, but the precise composition of all roots depends upon their age, size, and the conditions under which they are grown. Swedes, however, are decidedly more nutritious than white turnips after Christmas, and will keep much longer, so that they have become the principal root for winter feeding. The chief points in which their cultivation differs from that of ordinary turnips are: that they need a better class of land; and that they are earlier sown, and mature later.

Like all cruciferous root crops, swedes require a fine, moist, and well-manured seed-bed, and this, together with their early sowing, makes autumn cleaning and preparation of the land important. They may follow rye folded in March or April, but are more generally drilled after winter fallowing.

The requisite fineness of tilth is obtained by exposure to the winter's frost, and it is essential that the land should be clean as well as in good heart. In Scotland and the North of England swedes are almost always drilled upon ridges raised in well-tilled soil by a double or a single mould-board plough. These ridges are 27 to 30 inches wide, and the manure is spread at the bottoms, after which they are split over it. The ridges are thus reversed, and the dung lies under the apex of each of them. The seed is then deposited by a light two- or three-row drill, with concave iron rollers drawn by one horse (Fig. 38), and a light wooden roller also attached to the drill completes the operation. This is the ridge system of "making turnips" as it is called, and differs widely from the English method of sowing on the flat.

As to the comparative merits of the two systems, they vary with the soil and climate. In southern counties ridges are liable to dry, and on chalky and thin soils there is scarcely enough depth of soil for raising them. The flat system therefore prevails, and consists in bringing the land into a fine state of tilth, and drilling with a 5-coulter drill, set 18 to 20 inches wide between the rows. The superphosphate is drilled with the seed from a manure box, and the seed coulters open into the manure coulters, so that both seed and manure reach the ground together. The land is then lightly harrowed and rolled.

The disadvantage of the flat system is that there is no trace left of the rows until the seed appears above the surface, and hoeing cannot therefore be attempted until the plants are strong enough to stand the work. In this respect the raised ridge system is superior, as the sides of the drills can be hand-hoed, and the intervening spaces horse-hoed, as soon as, or even before, the plants appear. Excellent crops are produced under both methods, and it must be regarded as an accident of climate that the heaviest crops of swedes are produced upon the raised ridge system.

Ridges also focus the richest soil within the limits of each drill, and the farm-yard manure, being deposited immediately beneath the seed, yields up moisture which assists germination. So important is this considered to be that careful farmers allow no time to elapse between spreading the manure and splitting the ridges, the ploughs continuing at work at the dinner hour, after the spreaders have ceased in order that no drills shall be left exposed to the hot sun.

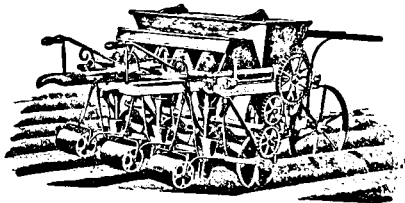

FIG. 38.—Ridge Drill.

**Manuring Swedes.**—Swedes are grown on many sheep farms without the application of dung. Three to four hundredweight of superphosphate are found to be sufficient in countless cases; and if the swedes follow rye or winter barley fed upon the land, 2 cwt. is a common dressing.

The amount and description of manure used are affected materially by climate. The swede crop is capable of producing 50 tons per acre, but 30 tons must be considered a heavy crop. Twenty tons is a usual estimate in the North of England, but is exceeded on the red lands of Lothian. On the other hand, 10 and 12 tons are looked upon as average yields on the thinner soils of Southern England, but in bad seasons crops of 5 to 6 tons are often to be seen. The success of both swedes and turnips depends much upon the season, and complete failure is not uncommon. It is therefore only to be expected that the heaviest crops should be produced in humid and cool climates, and that a moist season should cause an abundant supply of roots.

The capability of a soil as to yield exerts a marked effect upon the treatment; for it would be unreasonable to manure a crop heavily which cannot assimilate the food provided. Hence the great differences between the practice of the North and many parts of the South of England. In North Yorkshire Mr. Teasdale Hutchinson (Prize Farm) grows swedes on the ridge system, and uses 8 cwt. of artificials per acre besides dung, although the apportionment is varied according to circumstances. The land is of good quality, and the result is commensurate with the pains taken. One hundred swedes selected by judges on this farm averaged 10½ lb. each, and the grower suggested that the yield was 50 tons per acre! Whether this estimate was correct is not important, as the case is simply cited to show the necessity of favourable conditions before lavish manuring is adopted. On the Cotswolds it was found as the result of hundreds of experiments that any dressing of artificials over 3 cwt. per acre, did not give a profitable increase.

As to the description of artificial manure used, phosphatic dressings are the most effective. In Mr. Hutchinson's case the 8 cwt. consisted of 2 cwt. guano, 2 cwt. bone meal, 2 cwt. rape dust, 1 cwt. kainit, and 1 cwt. of nitrate of soda—a rather empirical mixture, but nevertheless well designed. Highly nitrogenous manures are perhaps better bestowed elsewhere than on cruciferous root crops, but in northern climates Peruvian guano, when it was obtainable, always produced good results. In the generality of cases, phosphatic manures, such as superphosphate, basic cinder,<sup>1</sup> basic superphosphate, and bone-meal are all successfully used, and it would be invidious to discriminate between them as to their comparative merits. Nitrate of soda and ammoniacal guano are better applied as top dressings during the growth of the crop, as when drilled with the seed they tend to check germination. Superphosphates and other phosphatic manures seem, on the other hand, to stimulate the early growth of the seedlings, and to produce no evil effects on the seed.

#### WHITE AND YELLOW FLESHED TURNIPS.

The cultivation of swedes and turnips is so similar that it has been thought advisable in this work to take swedes as the type, and instead of repeating details, to point out the principal differences in management between these closely allied crops. Some of these differences have already been mentioned, but it is important to bear in mind that swedes require better land and more liberal treatment than white turnips. Yellow turnips are intermediate in many respects, and will grow well on medium lands, although like all crops they do best on rich soils.

White turnips may attain heavy weights per acre upon poor sandy land, on which swedes would probably fail; but the quality of all roots is much affected by the conditions under which they are grown—a point which is too little observed in tables of analyses of various descriptions of roots.

Soils of a clayey character produce heavier and more nutritious roots than poor thin soils, as is shown by the fact that sheep, fattening cattle, and milking cows do much better on roots from good than from poor land; and the shifting of a lot of tegs from poor to good land, although on the same kind of roots, is soon marked by an improvement in their condition.

Turnips are suitable for autumn feed, and swedes for winter and early spring feed. Turnips are easier to break and lighter of digestion than swedes, and appear to be a good connecting link between summer and winter dietaries. They are also milder in flavour, and less liable to impart a "turnipy" flavour to milk. These properties particularly belong to white turnips; and yellow turnips are often used as a further and more gradual means of introducing swedes after the turnips are finished.

Seasons for sowing Turnips and Swedes.—Turnips may be sown in April, and in Scotch swedes are occasionally sown in that month.

<sup>1</sup> It has been shown that basic cinder drilled with swedes and other Cruciferae such as rape, is a satisfactory dressing, although applied in the height of summer, on both light and heavy soil.



Main crop turnips are sown in June and July, while main crop swedes are sown in May and June, and drilling is continued into July. Late turnips are drilled throughout July and August, in which latter case they are often grown upon corn stubbles. The sowing season therefore extends over the entire summer, but the crops are destined for different uses.

The earlier-sown roots attain their full growth and begin to show signs of decay as early as September, and this is as true of swedes as of turnips. Ultra early sowing is not to be recommended for swedes, because they are essentially winter food, and their keeping properties suffer if they are forced forward too rapidly. Early-sown turnips may easily be ready for consumption in July<sup>1</sup> in the South of England, and ought to be eaten by the end of September. Late-sown turnips continue to grow throughout autumn, and in mild winters up to February, and are hardier than early-sown swedes. They are well protected by their leaves, and produce small bulbs; and one object of sowing them is to produce a mass of green food for ewes and lambs in March and April. The towering stems of the latest-sown turnips and rape, crowned with yellow flowers, are often to be seen as late as May, stocked with ewes and lambs; and it is on such situations that a second root crop is sown instead of planting spring corn as a preparation for autumn sown wheat.

**Circumstances affecting Date, etc., for Sowing Root Crops.**—Besides latitude, which has been already discussed, altitude is important with regard to the date of sowing. On elevated situations early sowing is advisable, and a full month may elapse on the same farm between the drilling of swedes on the high-lying fields (usually poor in character) and the rich alluvial land at a lower level. The last week in May is not too early in the one case, whereas July may do in the other, so remarkably does climate affect management, even on the same farm. The latest possible date at which turnips or rape may be sown is about the first week in September, and that only under special conditions. Such late-sown crops are meant more for green fodder than for producing bulbs, and may also be remunerative for picking for market, but as a rule August sees the end of turnip drilling.

**Insect Attacks.** (See Agricultural Zoology.)

### CARROTS AND PARSNIPS.

Carrots and parsnips belong to the natural order Umbelliferae. Both are very common weeds, and so closely related to the cultivated species as to suggest them as the parent stocks from which carrots and parsnips were derived. In flower, seed, and foliage, as well as in habit of growth and flavour, they are almost identical, the main difference being the development of the fleshy and fusiform roots in the cultivated plants. They are also capable of improvement, and parsnips have been raised from the wild stock. As a weed the carrot is often widely spread over light land under sainfoin or grass seeds, while the parsnip is found in hedgerows and waste places.

<sup>1</sup> In the North swedes are generally sown in May and turnips in June. In Northumberland June 20 is considered somewhat late for white turnip sowing.

As cultivated crops they are only suitable for deep soils, free from stones, which divide the roots into fangs. The carrot does well on deep sands, as well as on clay, but depth is essential in all cases. The parsnip is best grown on rich and deep soils of fairly heavy character, and both crops are expensive to lift, and require much care during their early stages. They are valuable stock foods, for carrots are highly esteemed by horse-keepers, and parsnips for fattening pigs, both being mucilaginous and rich in sugar.

They are capable of producing 30 tons per acre in favourable situations. On the other hand, 8 to 12 tons of carrots and a somewhat heavier yield of parsnips are more ordinary crops.

**Carrot Cultivation.**—The White Belgian and Red Altrincham are the best-known field carrots. The preparation of the land entails deep autumn, or winter, ploughing and manuring, and rigorous weeding, as well as interculture during the entire growth of the crop. The peculiarity of the seeds is their ciliated or hairy margins, which causes them to hang together. This difficulty is now met by a process of dressing by which most of the bristles are removed. It was formerly the custom to mix the seed with moist sand to separate it, but after dressing this should be unnecessary. Two to four pounds per acre are sufficient at ordinary widths.

The seed is slow in germinating, and the young plants are puny, and liable to be hidden by annual weeds which spring up rapidly and cover the surface. For this reason sowing in double rows on raised ridges is better than flat drilling; but mixing the seed with a few pounds of barley or oats helps the eye in tracing the rows in ordinary flat drilling.

The best time for sowing is the latter end of March, or early in April, when a fine surface can be easily produced. The land must be presumed to be already deeply tilled and pulverized, and the surface should be well harrowed and smoothed by light rolling. The seed is then deposited by a drill, 9 to 12 inches apart in the rows; or in double rows, 5 inches apart, with 23 in. spaces between them. This last system is commonly practised when raised ridges are used.

Much care is necessary to save the young plants from being smothered by weeds, and hand-weeding, kneeling on a cushion, is, as in the case of flax, to be recommended. The care requisite in carrot cultivation, and the small area generally devoted to it mark out the crop as specially suitable for small-holders and their families. On larger farms either the push-hoe or a short bladed ordinary hoe is used. The surplus plants are then hoed out, leaving the survivors 4 inches apart. Carrot cultivation allows of a good deal of variation according to the objects aimed at. A superior marketable variety may be selected, and successive hand drawing and bunching of young roots for market may be preferred to singling by hoes.

**Manuring Carrots.**—Well-rotted farm-yard dung may be supplemented with superphosphate and sulphate of potash; and a top dressing of nitrate of soda, scattered over the young plants, is always beneficial.

The rows are too close for horse-hoeing, except when the seed is sown on raised ridges; and repeated hand-hoeings are necessary

until the plants are strong. The fineness of the tops fits the carrot for systems of alternate growth with other crops, such as mangelwurz. Thus, alternate rows of mangels and carrots agree well together, if they are not too narrowly drilled. For example, a row of mangel may alternate with one double row of carrots, the width between being 18 inches in both cases.

The lifting of the crop is always expensive, not only on account of the length of the roots, but because of the ease with which they snap. They are best loosened with a grape, and drawn out by a second hand, who cuts off the tops.

They should be neatly packed in long rounded clamps 2 ft. 6 in. wide at the base, with all the crowns to the outsides and all the tails pointing towards the centre. This arrangement naturally forms a domed heap, which is then covered with loose straw, over which is placed a layer of earth, which may in turn be thatched. Air-holes every yard in length along the top of the heap are easily extemporized by wisps of straw extending from the carrots to the outer air; and 2 in. draining pipes at the base of the heap, let in at similar distances, complete a system of ventilation. Carrots should be stored dry, in open weather, and are liable to heat if too closely covered. This also applies to parsnips, but many growers consider that they keep best in the ground until required. Small quantities of carrots may be stored in buildings under straw, or in sand.

Parsnips are sown late in February, and are in several respects less difficult to cultivate than carrots. The seed is larger, and plain round the margin. The plant does well on fairly strong land, which should be brought to a fine tilth by autumn cultivation. Six to seven pounds of seed per acre are sown, and some growers mix it with moistened sand in order to secure perfect distribution. The details of cultivation are in most respects similar to those recommended for carrots, but the plant is more robust, and the leaves are less finely divided and more conspicuous. The roots are larger, and require a space of 12 to 15 inches between the rows and 8 inches between the plants, and the produce per acre under favourable circumstances may be 20 tons.

## CHAPTER IX.

### FODDER CROPS.

Kohlrabi is scarcely a root crop, although the enlargement of its stalk confers upon it many similar properties. It carries its leaves upon the bulbs, which, on falling, leave scars similar to those seen on cabbage stalks. Its foot-stalks raise the bulb well above the ground, and enable sheep to consume the whole without waste. The leaves are of equal nutrient value with the stem, and, as they continue to develop during winter, the crop affords suitable food for ewes and lambs. It may be grown among kale or rape, and the combined crop makes an excellent food. The principal varieties are either purple or green-topped, of which the latter is more commonly grown. They are also classed as oblong and round, and early and late. They may be raised in seed-beds and planted out, but on the whole, thrive better when drilled where they are meant to stand. The cost of the seed has always been a bar to their extended cultivation, and there are many districts in which they are practically unknown.

Kohlrabi are excellent for transplanting on to headlands, manure heaps, rick stances, and other vacant spots, where cabbages are often used with the same object. It is by no means clear that kohlrabi possesses any great advantages over swedes and turnips, except on peaty soils, where other root crops grow light and hollow. It also makes a change for both the soil and stock. It is claimed for kohlrabi that it is especially capable of resisting drought, and that it is subject to fewer diseases and insect attacks than other root crops.

It is unquestionably very hardy, and can be left out during winter. When stripped of its leaves it keeps well under straw. In flavour it resembles cabbage stalks, and is highly nutritious; and it may be cooked as a vegetable.

Cabbages rank high among farm crops, and deserve wider attention than they receive. The mere fact that they bear transplanting without any injury, but rather with advantage, is a great recommendation. They grow well on all descriptions of loamy and clayey soils, and may be developing in seed-beds while the field is under preparation for planting them out. They are better raised in early autumn than in spring, and are fit for transplanting in October, and planting is continued through November into December. It may also be resumed in January for filling up blanks, and, finally, there is always a sale for surplus plants. At 6*d.* a hundred, or 5*s.* per thousand, a cabbage seed-bed will be remunerative, and is a much cheaper method of

raising plants than buying them wholesale at even 2s. 6d. per thousand. Besides, home-grown plants are fresher, and are not liable to heat or turn yellow in trucks, as in the case of purchased plants.

A cabbage seed-bed is easily prepared, and should be on good land. It need not exceed one-twentieth part of the area it is meant to plant, and 2 oz. of seed are required per rod of  $5\frac{1}{2}$  yards square. This is  $\frac{1}{180}$  part of an acre, and would be equivalent to 1 lb. of seed for 1 acre of land to be planted.

*Directions for making the Seed-bed.*—Select a piece of vacant land of good quality, and in a sheltered situation. Let it be ploughed (or dug), thoroughly cleaned, manured, and again ploughed; harrowed, rolled, and brought into a fine surface tilth. Wheel in the seed, and once harrow, and lightly roll. A top-dressing of superphosphate scattered over the bed is also advisable. Or, the seed may be drilled in rows 9 inches apart. The bed should be kept free from weeds by hand-picking or by the push hoe, and protected from small birds.

The bed should be prepared in July, and sown the first week in August or within that month. The plants germinate and grow quickly, and are ready for planting out in September and October. Slugs are often troublesome, and the best preventive is to sow soot over the young seedlings.

*Planting Out.*—It is one of the advantages of cabbage cultivation that the land may be preparing while the crop is growing in the seed-bed; and this is the reason why planting out is better than drilling the seed at once in the field. Thus a corn stubble may be broken, cleaned, and dunged after harvest in good time for planting; and one simple plan is to plough and press the prepared land, and plant in the marks left by the presser, 18 to 27 inches between the rows, i.e. in every alternate or third press-mark. A still better plan is to plough and press the land, and mark it out crossways with a drill in which the coulters are well weighted and set to the required width. This marks off the ground into squares, and the plants are placed at the points of intersections of the lines. This gives two distinct directions in which the plants can be horse-hoed, and a geometrical appearance to the field, showing lines in four directions—at right angles and diagonally. If 18 inches apart both ways, exactly 19,360 plants will be required per acre, or say 20,000. At 36 inches apart, which is suitable for large Drumhead cabbages, one-fourth the above number, or 5,000 plants per acre, will suffice.

Width apart varies with the kind of cabbage, and the narrower spaces will be found sufficient for Imperials, Nonpareils, Sheepfolds, and Enfield Markets, while Batterseas and Drumheads are better for having plenty of room. The plants should be freshly drawn from the seed-bed, and the long ends of the roots trimmed off with a knife. The roots are better dipped in a cream of superphosphate, and dibbled in with a cross-headed, ironshod, hand tool.

The roots of cabbages, as with other seedlings, must not be doubled in planting (Fig. 39), and the plants are batted and heeled in, so as to be firmly placed. If a plant comes up when gently pulled

with finger and thumb at the tip of the leaf, it is badly planted, but if the tip breaks it has stood the test. In January or February blanks should be filled up from the seed-bed, and the remainder of the plants may then be sold for enough to pay the rent of the land.

Cabbages require early attention in the spring in the form of both horse- and hand-hoeing, and it is then that the comfort of the quadrilateral system of planting will be realized. Cabbages derive great benefit from a pinch of nitrate of soda, dropped near, and around, each plant in March.

*Direct Drilling in the Field.*—Cabbages may be drilled like other root crops, but the cost of the seed is somewhat prohibitive. Good seed often costs 5s. per pound, whereas turnip and swede seed may

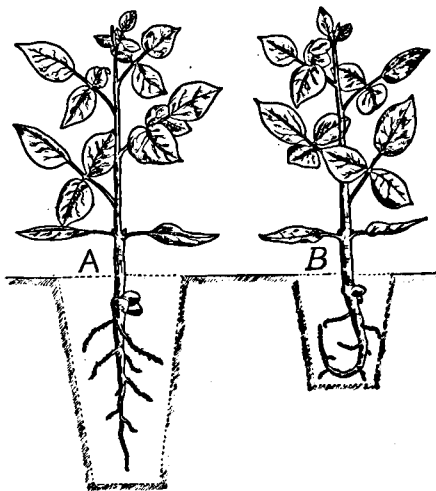

FIG. 59.—A, proper method of transplanting seedling, the roots being given ample freedom; B, wrong method, the roots cramped and turned upwards.

be bought for 6d. Of course the cost of planting (about 10s. per acre) is saved, but the cabbage plant is exceptional, as it benefits from being transplanted. A case is worth recording in which the young plants in the seed-bed were badly clubbed, but after transplanting the disease disappeared, and gave no more trouble. Batterseas are well suited for drilling directly, and the seed is cheap. If the cabbage seed is diluted with burnt (killed) mustard seed the objection to cost is done away with for drilling, but this would not answer for seed-beds.

*Uses for Cabbage.*—Autumn-raised and planted-out cabbages are ready for use in July or August. They may be cut for market or carted on to grass land for cows, and are extremely useful during the

height of summer, when pastures are burnt up, and before early turnips come in. They may be raised in spring, but, on the whole, autumn seed-beds are to be preferred. Flockmasters maintain that where seed is drilled the plants do not "heart in", and the foliage, being loose and open, there is no risk of digestive disorders through the sheep partaking of the softer vegetable tissue decayed by the action of frost.

*Second Growths.*—When cabbages are cut early, the three lowest leaves may be left, and they will develop several small heads from the buds at their axils. Or, if folded with sheep, they should not be too hard eaten, and a second growth will soon appear. The writer has known three feeds produced in succession from the same stocks. Second growths are not, however, in high favour for lambs. They do for older sheep or ewes, but lambs are extremely susceptible to rankness of any kind. For this reason many good farmers prefer to break up the cabbage fold and drill in turnips; but in droughty years the stumps, having got a good and deep hold of the ground, will be more likely to produce keep than a sowing of turnip seed.

*Other descriptions of Cabbages.*—The endless variety of *Brassica oleracea*, or cabbage, is remarkable. The plant appears to possess the property of plasticity in an extraordinary degree. It develops under cultivation in such widely divergent types as close and open-headed, cauliflower, broccoli, and borecole; majors and brussels sprouts; wrinkled savoy, and big Batterseas. Almost all of these are cultivated in open fields, but some of the finer sorts are restricted to gardens. Kale and kohlrabi are mere offshoots from the cabbage, and the turnip-rooted variety is another, of which we know little in this country.

It is curious to notice that while the plant "sports" freely as regards leaves and stems, it remains constant in its flower and seed, so that it is often difficult to distinguish between them. It is true that turnip seed is smaller than swede seed or cabbage, and that rape seed is blacker than swede seed, but there is no marked difference to the ordinary eye. It is necessary to grow cabbage seed where it is not in close proximity to other beds, as cross-fertilization by bees may occur, and this may account for the high price of warranted pure seed of particular varieties.

*Why Cabbages should be more widely grown on Clay Land.*—(1) Because they thrive well on clay soils. (2) Because clay land works best in the autumn, and can be prepared before it is planted with cabbage. (3) Because the crop can be folded on the land or carted off it in the dry season of the year. All these peculiarities mark out the cabbage as a crop which might well precede wheat, and take the place of summer fallowing. When viewed in all its endless variety of form, and its adaptability for home consumption and marketing, the cabbage seems particularly adapted for small holdings, especially after early potatoes, but as a fold for sheep and a help to milking cows it is equally useful to arable sheep farms and dairymen.

*Kale.*—What is known as thousand-headed kale is practically an open-headed cabbage, and owes its luxuriance to the development of

axial buds which may be seen at the base of every leaf. It is extremely hardy and stands any winter, and is a companion crop to rape. It produces a globular but loose head, and often reaches a height of from 4 to 5 feet. It is usually drilled where it is meant to grow, but may be transplanted with success.

Kale may be sown in April for early autumn keep, and in August for spring folding, for which purpose it resembles rape. It is considered less nutritious than rape, but safer for lambs in the spring, and when grown upon suitable soil produces a much heavier crop. It is thought to "draw" the land more than rape, which may be due to its large and fangy roots, which sometimes stop the plough, and are therefore carried off the land and rotted in heaps. The same, in a less degree, is true of rape roots.

*The Cultivation of Kale.*—There is a great resemblance between the cultivation of all the root crops. The land must be deeply cultivated and well manured, after a well-worked winter fallow; or broken up after an early fodder crop fed upon the land. The choice of the particular root or allied crop is chiefly controlled by the season, for it may be too late for mangels, in which case swedes may be sown; or too late for swedes, when turnips may be substituted, etc., etc. Choice is also affected by the character of the land, which may be too weak or thin for one crop and yet good enough for another; but, apart from these considerations, the cultivations are very similar, so much so that it is unnecessary to enter minutely into details for each kind of root crop.

Rape has been spoken of as a companion crop to kale, and the two have been compared. Rape is, however, an older favourite, and is much better known, and more widely grown. It thrives best upon deep vegetable soils, and is a great favourite, under the name of coleseed, in the Fen country, where it produces extraordinary crops, rivalling swedes in weight per acre, and scarcely requiring to be fenced with hurdles, the sheep eating their way through it. Rape may, however, be grown on almost all classes of land, from clay soils, scarcely fit for turnip husbandry, to the thin soils of the Upper Chalk.

It is highly esteemed by all sheep farmers, especially for summer and spring keep, and, like kale and cabbages, it throws up a second growth after folding. It is one of the best preparations for wheat, the young plants sown after it always being of good colour and full of vigour. Its success greatly depends upon horse- and hand-hoeing. When singled it produces stout plants and strong roots, but when left unsingled, as it may be late in the season, it forms a fold which can be eaten down to the bare ground. One of the best varieties for ordinary land is the Essex dwarf, but Giant rape is suitable for Fen lands, and grows to a much greater height and thickness, as above mentioned.

White Mustard is closely allied to the Brown Mustard of the table, but carries a white seed. It belongs to the same genus as charlock, but is not liable to infest the soil upon which it has been grown. It does not possess great fattening properties, but is a wholesome food for store sheep or ewes. It is also quick in arriving at maturity,



and is much used for green crop manuring where the practice prevails.

It is liable to be cut down by frost, and is therefore a summer or autumn fodder crop. Mustard may be regarded as an extemporized crop, coming into extended use after droughty seasons in which root crops have failed, and supplying green food up to November.

Its cultivation is simple, the seed is cheap, and the crop ready for folding six or seven weeks after sowing. It may be cultivated on any description of soil, and produces tall and luxuriant foliage upon good land, or when manured with superphosphate. It is frequently sown upon failed root land, in which case extra tillage is unnecessary, and the seed is wheeled and harrowed in at the rate of 25 to 30 lb. per acre. When the land is stale or weedy, it should be ploughed before it is sown, and it is noticeable that, like most seeds, mustard springs up more quickly from a fresh and consequently moist furrow than from a dead surface. It is best consumed when it is coming into flower, and is a suitable food for ewes during the mating season.

#### GROWING ROOTS FOR SEED.

This is a special industry largely in the hands of the great seedsmen. It is intimately associated with the selection of suitable "bulbs", and the raising of pure stocks; and precautions are necessary to prevent cross-fertilization, except where it is intentionally carried out for hybridization. Ordinary farmers are therefore placed at a disadvantage in raising seed, and generally prefer to purchase what they require from accredited firms. Seed-growers, however, often trust the stocks to good farmers for the production of large parcels of seed.

When well-shaped roots are selected they are transplanted to a nursery, where they throw up flowering and seed stems, which are carefully netted in order to protect them from birds. The seed is sown late in the season on clean and prepared land. Every care is taken in harvesting, and, later, in threshing and cleaning, for which purposes machinery of a very perfect character has been invented.

We have always found the principal seedsmen only too willing to conduct farm students over their establishments, and to spare no pains in giving explanations of the many devices employed by them in order to secure reliable types and strains of seed.

Those who have conducted variety trials of cereals know too well the difficulty experienced in keeping each variety pure, and factors too numerous to mention render this impossible on an ordinary farm.

There are numerous seeds that a gardener can save for his own use, such as beans, peas, onions, and many others, but let him try to save his own seeds from a cauliflower, or any other cruciferous plant, and very soon he will find himself in a hopeless muddle, unless he is skilled in this particular industry.

As with breeding live stock, so it is with plants, the breeder must be an expert, and possess a thorough acquaintance with each particular plant if it is his intention to improve by selection, hybridization, or cross-fertilization.

## NON-CRUCIFEROUS FODDER CROPS.

All the root and fodder crops yet considered, with the exception of mangel, carrots, and parsnips, belong to the great natural order Cruciferæ, characterized by bearing cross-shaped flowers. These crops are all cultivated upon the "fallow" share, either as root or kindred crops, such as cabbage, rape, and kale, and are cultivated on similar principles.

The crops now about to be described occupy for the most part the third year of the Norfolk rotation, coming in between two corn crops, as for example clover. There are exceptions, as in the case of vetches, trifolium, and the fodder cereals, which mostly precede roots and figure as catch crops. They to a great extent belong to the order Leguminosæ, or podded plants, some seeding in pods and some in capsules. They also include several grasses such as the rye-grasses, so that the group is of varied nature from a botanist's point of view. Agriculturally, they may be divided into two classes. First, those which require special cultivation, including ploughing. Second, those which are sown on the surface, among corn already in possession of the land.

Vetches.—Among the first class, vetches or tares are the most important for several reasons. (1) They thrive upon clays and upon all calcareous soils, where they may be successfully grown without manure of any kind. (2) They are of two types—winter and spring, and with the aid of these two varieties they can be sown in succession, so as to produce green food from May to October inclusive. (3) They are adapted either for cutting, or "soiling" in yards; for folding upon the land, or for ripening as seed. (4) They may precede late-sown turnips, or take the place of a bare or summer fallow, in which case the land may be cleaned by a system of half or rag fallowing for early-sown wheat.

Vetches generally follow a corn crop, either with a view to being followed with late roots, or to making a half fallow for wheat after the vetches have been folded.

*Cultivation of Winter Vetches.*—The corn stubble is broken up by a steam or horse cultivator, the former being preferable, and thoroughly cleansed from weeds. It is then in many cases dressed with 10 or 12 tons per acre of farm-yard manure, ploughed in with a 4 or 5 in. furrow. The land is then well harrowed, and 2 to 3 bushels of seed are drilled in rows 7 inches apart. The seed is better mixed with half a bushel of winter oats, or of wheat, to  $1\frac{1}{2}$  or  $2\frac{1}{2}$  bushels of clean vetch seed to make up the above quantity.

When thinly planted, vetches are found to encourage weeds, but when thickly planted they become a "smothering" crop, so that on foul land a thick seeding is often recommended. The seed is sown from September to December, and sowing is again continued during January and February, the winter variety being best during these months. Spring vetches are sown in March, April, and May, and thus a succession of fresh food is obtained. Vetches have often been spoken of as the sheet-anchor of arable land sheep farmers. Early sowings are ready in May, and later sowings come on as required,

and what are not needed for consumption by stock can be harvested and threshed.

In folding vetches with sheep, various expedients have been suggested for preventing waste, for luxuriant crops are often liable to be trodden under foot. They may be mown and carried to cribs ; and cross-framed hurdles have been used which may be turned over and thus advanced as the sheep eat the fresh fodder through the open bars. On most extensive farms such methods require too much time and labour, and the problem is solved in a more practical fashion, by allowing the most forward and favoured lambs a first chance upon the newly pitched out fold. After they have, so to speak, creamed the bowl, a younger, later, and less pampered lot of lambs, or the ewe lambs intended for stock, are given a turn on the same fold ; and, finally, the stock ewes clear up what is left, and leave the ground clear and ready for ploughing up.

This is not a bad example of how business men overcome practical difficulties. Each section of the flock is well satisfied with its treatment, for ewes and ewe lambs not only are accustomed to live harder than fattening lambs, but are all the better for frugal fare.

Trifolium, or crimson clover, is largely cultivated in the southern counties, but is seldom seen in the north. It is readily distinguishable in all its stages. Its seed is larger than that of other clovers, globular in shape, glossy, and cheap to buy.

The leaves are obovate in form, and covered with down. The flowers are borne on spikes instead of on globular heads, and are of rich crimson colour, excepting the white varieties, which are later than ordinary crimson clover.

Trifolium is accredited with being more easily cultivated than any other crop. Its seed may be scattered over standing corn, and is trampled in or covered by the traffic of harvesting. Or it may be wheeled in with a seed barrow on untouched stubbles, and dragged or rolled in. This is the ordinary plan pursued, and ensures the following essential conditions for success : (1) It encourages earliness, for sowing may be performed on any damp morning when harvest operations are interrupted ; (2) the plant prefers a firm substratum to a loose seed-bed, and by these methods a surface tilth is obtained sufficient to bury the seed ; and (3) the final rolling with a heavy roller further consolidates the land and completes the cultivation.

In some cases the stubble is shallow-ploughed before sowing, but it has been observed that slugs are more destructive on loose land, where they can hide during the day, than on a firm and unploughed soil.

Trifolium is very hardy, but ought to be strong before winter sets in. It should therefore be sown in August, or by the middle of September, and October is too late, as the young plants are then liable to slug off, and that in a single night. It thrives best upon gravelly, alluvial soils, but may be grown on any land of loamy character except upon white chalk. It comes in as a connecting link between winter barley and vetches, and is often chosen as a good position on which to wean lambs. It is, however, unsuitable for mowing for hay, as the stems soon become hard and bare, the foliage

disappearing as the plant matures. As in other fodder crops the maximum value is attained when the plant is in full bloom.

The Clovers.—What are known as the clovers belong to three genera—*Trifolium*, *Medicago*, and *Lotus*. They are all trifoliolate (three-leaved), but differ in fructification, the clovers developing capsules, the medicks spiral pods, while *Lotus* develops long pods arranged like a bird's foot. They are all included under the term "small seeds", and are usually sown in mixtures with rotation grasses. They vary in longevity, some being annual and others perennials of various durations.

The most important member of the clover group is *Trifolium pratense*, or red or broad clover (Fig. 40). This plant is too well



FIG. 40.—Red Clover (*Trifolium pratense*).

known to need description. It is of robust habit of growth, and excels all other ordinary varieties in luxuriance. It, however, is subject to clover sickness, which appears to be primarily due to want of suitable food, and secondarily to nematode worms. That sickness is caused by want of nutrition is indicated by the immunity of some soils from the disease, and the fact that it has been grown upon the same rich garden soil for a great many years in succession (at Rothamsted) without showing any signs of failure. Still, in ordinary course of cropping it may easily be grown too often, and the four years rotation is too short to ensure its success. It is indeed found

advisable on most land to divide sowings on red clover by intervals of eight years. If it were not for this tendency to "sickness", it would probably oust all other clovers, as they are chiefly used as safeguards against the failure of red clover.

**Alsike** or *T. hybridum* (Fig. 41) is of Swedish origin, and is intermediate in character between red and white clover. It is fairly widely cultivated, but not nearly to the extent of red clover and the other members of the group. The leaves are broad and furnished with conspicuous stipules; the stems are strong, and the flowers mixed red and white. The seed is small and angular, like that of white clover, but green when new, and approaching to black when



FIG. 41.—Alsike or Swedish Clover (*Trifolium hybridum*).

over a year old. It is supposed to do well on clay and damp soils, but thrives on any soil suitable for mixtures of clover.

**White (Dutch)** or *T. repens* (Fig. 42) is peculiar for its distinctly perennial character and spreading nature. Its roots are stoloniferous or creeping (*repo*, to couch or creep), and promote the extension of the plant from centres. It is found in all pastures and on roadsides, and is an important ingredient in mixtures for laying down to permanent grass. It makes but little show the first year, and may be omitted from one-year mixtures; but it gradually spreads, and is to be seen in the aftermath, and in subsequent years' growths.

advisable on most land to divide sowings on red clover by intervals of eight years. If it were not for this tendency to "sickness", it would probably oust all other clovers, as they are chiefly used as safeguards against the failure of red clover.

**Alsike** or *T. hybridum* (Fig. 41) is of Swedish origin, and is intermediate in character between red and white clover. It is fairly widely cultivated, but not nearly to the extent of red clover and the other members of the group. The leaves are broad and furnished with conspicuous stipules; the stems are strong, and the flowers mixed red and white. The seed is small and angular, like that of white clover, but green when new, and approaching to black when



FIG. 41.—Alsike or Swedish Clover (*Trifolium hybridum*).

over a year old. It is supposed to do well on clay and damp soils, but thrives on any soil suitable for mixtures of clover.

**White (Dutch)** or *T. repens* (Fig. 42) is peculiar for its distinctly perennial character and spreading nature. Its roots are stoloniferous or creeping (*repa*, to couch or creep), and promote the extension of the plant from centres. It is found in all pastures and on roadsides, and is an important ingredient in mixtures for laying down to permanent grass. It makes but little show the first year, and may be omitted from one-year mixtures; but it gradually spreads, and is to be seen in the aftermath, and in subsequent years' growths.

The plant is too small for hay, and is low in stature, but it is a valuable fodder for grazing animals, and especially for sheep.

Black Medick, known also as "Hop", Nonsuch, Trefoil, and Yellow Clover, is a general favourite, and forms a part of most mixtures and is also frequently sown alone. Its botanical name is *Medicago lupulina*, and it is closely related to *M. sativa* or lucerne. The seeds of the two plants are so much alike that only expert seedsmen can distinguish them, but they differ in foliage and flower, as well as in other respects.

Trefoil is fibrous-rooted, of delicate appearance, and slender stem. Its leaves are small, and it flowers in small globular heads. It is



FIG. 42.—White or Dutch Clover (*Trifolium repens*).

a free seeder, and therefore maintains its position in permanent pastures. It yields a fine hay, very different from the bold "bony" herbage of red clover, and when it is grown alone it rarely yields more than 1 ton to the acre. It is earlier than the other clovers, generally flowering in April, and ready to cut in May. It is considered to be excellent for sheep, and to possess health-giving properties. It is easily secured, owing to its general slenderness, and often comes out of the rick without much loss of its natural green colour. Trefoil is frequently used as the precursor of a root crop, for the plant is of little use as aftermath, and as soon as the hay is

secured the ground is broken up and dressed for roots in good time for main crop swedes or turnips.

Lucerne (Fig. 43) is highly esteemed over most of the world. It is the Alfalfa of the Argentine, and is widely grown over Europe. It suits dry climates, as its roots are extremely strong, and penetrate to several feet in depth. It is, in fact, a difficult matter to dig up a root of lucerne after it has attained an age of two or three years. It is perennial in its nature, but requires renewing at intervals, principally because the ground becomes weedy.

Lucerne has been much recommended of late years as an ingredient of ordinary mixtures, for dry calcareous uplands, but cannot always be relied upon to "take" successfully. It is more commonly sown



FIG. 43.—Lucerne (*Medicago sativa*).

on small and confined areas near farm buildings, for horses. It produces but little the first season, but gradually improves, and arrives at full bearing about the fourth year, after which it continues prolific for a variable period.

Many essays have been written upon the wonderful properties and capabilities of lucerne, and systems have been described in which it is grown in alternate rows with other plants, in order to facilitate interculture and keep the ground clean, as well as to encourage a maximum development of the plant.

There are two principal methods of cultivation, both of which possess advantages. The first is special, and consists in deeply



ploughing or trench ploughing a suitable area. The best soil for the purpose is calcareous, but it may vary in character from heavy to light. It must, however, be deep, and fissured, to admit of the downward passage of the roots, and the subsoil must be dry. Artificial draining may remedy natural wetness, but the roots are liable to penetrate and find their way into drains and to choke them up. The crop is cut green, and yields three or four cuttings during the season. It resists the severest droughts.

When lucerne is grown alone, the deeply ploughed land is well manured and then again ploughed for seeding. It should be well harrowed and rolled, and the seed is drilled in rows 9 to 12 inches apart in April, at the rate of 20 lb., or if narrowly drilled, 25 lb. per acre. The older authorities laid great stress upon horse- and hand-hoeing every year, to keep the rows clear of weeds, but this entails too much trouble and labour for modern farmers. It is now recommended to broadcast the seed over a well-cleaned area, using as much as 30 lb. per acre mixed with such vigorous grasses as cat-tail (Timothy) cock's-foot and meadow fescue. These form an undergrowth which occupies the surface and excludes weeds, and the tall lucerne towers above them during the growing season.

The system of cutting and removing the crop is naturally exhausting, and suggests top-dressing with 5 cwt. basic slag and 2 cwt. kainit, as required, to renovate the ground. The expense per acre of such dressings is, however, considerable, and the net profit on the application is sometimes inappreciable. Lucerne, like other leguminous crops, stores up nitrogen, so that the soil is richer in that constituent after producing many cuttings than it was originally. It, however, benefits from applications of nitrate of soda, as shown by Dyer, and that to a marked degree. The same is true of clover, vetches, and other leguminous crops, although they are able to obtain nitrogen from the air. It would therefore seem that the effect of nitrate of soda is due to its immediate action upon a hungry plant, which, although it can accumulate nitrogen in its roots, stems, and foliage, also takes it from any available source. There is therefore no inconsistency in a leguminous plant benefiting from nitrogenous dressings. The dying out of leguminous herbage on land constantly manured with ammoniacal salts appears to be due to their being crowded out by grasses rather than to direct poisoning effects.

Sainfoin (*Onobrychis sativa*) (Fig. 44) is chiefly grown upon the chalk and limestone hills of Southern and South-Western England. These hills are not adapted for laying down to permanent pasture, for, although they form natural downs, the herbage is difficult to reproduce after it has once been broken up. It is here that sainfoin comes in as a substitute for permanent pasture, for it is durable, and capable of holding its place for an indefinite number of years (see Rotations). On wide farms in Wiltshire, and on the Cotswold Hills of Gloucestershire, it has long been the custom to keep a very considerable area of arable land under sainfoin, and the system is associated with old-fashioned profitable farming. It is the reverse of intensive cultivation, but keeps down expenses, and favours the

maintenance of sheep ; and the plant is supposed by shepherds to be particularly wholesome.

Sainfoin may be known by its flesh-coloured, vetch-like, flowers and its pinnate leaflets, from which it has derived its French name of *cinquoin* in contradistinction to trefoil. It is also known as *St. Foin*, or *holy-hay*. It is a robust plant, and produces from  $1\frac{1}{2}$  to 2 tons per acre of high-class hay.

*The Cultivation of Sainfoin.*—The fact that sainfoin is intended to occupy the ground for several years shows the importance of sowing it upon clean land ; and that it can only be successfully sown after intervals of from twelve to twenty years shows that it is scarcely likely that more than one field can be prepared for it in any one season. Great care is also necessary to secure clean and pure



FIG. 44.—Sainfoin (*Onobrychis sativa*).

seed of English growth, and of the best character. Foreign seed is not reliable, nor is English, unless its history or pedigree is known. Foul samples are only too common, because sainfoin soon becomes infested with "lop" (*Bromus mollis*), burnet, and many other weeds. It is therefore better to pay a good price to a seedsman for thoroughly cleaned seed than to purchase from neighbours.

The seed is enclosed in a capsule which, when well harvested, is bright and of light-buff colour. When opened the one seed within is seen to be of black or dark-brown colour, filling the cavity, but in poor samples many capsules are empty, or occupied with abortive seeds. Burnet (Fig. 45) closely resembles sainfoin, but is readily distinguished by its four-sided seed-vessel, which is distinctly different

from the two-valved sainfoin with its characteristic reticulated markings. The leaves of burnet are also notched or serrate. That it is not entirely valueless as a fodder plant may be granted, and that it is suitable for certain classes of dry, chalky soils; but it is very inferior to sainfoin and must be regarded as an adulteration.

Sainfoin seed is usually sown rough or unmilled at the rate of 4 bushels per acre, upon young corn, in March or April. It may also be sown upon wheat and barley, but oats are too heavy, and therefore liable to kill the young plants. If sown upon wheat, the land must first be well harrowed, and this is beneficial to the wheat, and also makes a tilth for the sainfoin, which is drilled across, or diagonally, to the wheat rows, and then once harrowed and rolled.



FIG. 45.—Burnet (*Poterium sanguisorba*).

When sown on barley, the seed corn and the sainfoin may be mixed together, and sown at one operation, and harrowed and rolled in together. Or, two drills may be used, following each other; the sainfoin being deposited diagonally across the barley rows. It is advisable to wheel in or broadcast about 1 gallon (6 lb.) of trefoil with sainfoin seed, to cover the ground and keep down weeds, as sainfoin plant is weak in its early stages.

This is all that need be said about seeding, but there are several points of importance in the management of the young crop. In the first place, sainfoin is better left ungrazed after harvest, to allow the plant to thicken and establish itself. It is also best left ungrazed in the following spring, and mown the first year for the same reason.

As an alternative it may be folded with sheep the first season after the plant has attained a good growth, but not before. After these preliminaries, the ground may be grazed on ordinary principles, and the plant will last for from seven to ten years.

Sainfoin soon dies out on damp subsoils, and even after wet summers, and lasts longest on dry fissured soils such as are found on oolitic limestones and chalk downs. Giant sainfoin produces a heavy crop of hay, but is undesirable because of its short duration, which may also render the soil unfit for a subsequent sowing of lasting English seed.

Sainfoin ranks high as a hay crop, and should be cut when in full flower. It is excellent for fattening bullocks, and for lamb feed. The hay is, however, often injured by being overdried before lifting and the consequence is a loose truss and a diminution in value. However necessary it is that any kind of hay should not overheat or "fire" in the rick, it is also of importance that it should "sweat" to a sufficient degree to become compact and develop flavour.

**Maize.**—The climate of the British Isles is too uncertain for the cultivation of maize as a corn crop, and although trials have been carried out with acclimatized varieties, the results have not been satisfactory, the plants being liable to develop a dwarf habit of growth, and the cobs being undersized and producing a small berry. In some market districts the plant has been cultivated successfully as a vegetable on small-holdings, the green cobs realizing about 1s. 6d. per dozen. The crop, however, is chiefly grown as fodder in this country in many of the warmer districts, and as such it is extremely useful to dairy farmers, when pastures become burnt up and parched during periods of drought in the late summer.

It is not difficult to cultivate as fodder and succeeds on well-manured soils of medium consistency, provided the soil temperature is not too low, as when such is the case, although the seeds may germinate quickly, the seedlings do not grow freely, and it is especially at this stage that they require an abundance of sun heat. A cold summer and frosty nights are alike inimical to success. When grown on the thin upland soils of Hampshire the plants hardly ever attain to more than 2 or 3 feet in height, while on some of the heavier woodland farms in a warm dry summer stems averaging 11 feet in height when in flower have been grown.

The manuring of the land for maize is practically identical with that recommended for mangel, and sowing is best performed from the middle of May to the middle of June.

The importance of sowing good seed cannot be over-estimated, and this can now be secured from any of our leading seedsmen. The White Horsetooth (*Dent de cheval*) or Giant Caragua have proved the best varieties where a heavy yield is desired. The seed is best drilled with an ordinary drill, as for beans, at the rate of 3 bushels per acre, allowing an average of about 18 inches between the rows to admit of horse-hoeing. Many failures in the cultivation of maize are directly attributable to the ravages of rooks, and this can only be obviated by stringing the field immediately after sowing with binder twine attached to stakes or spars about 2 feet in height. Horse-hoeing, as

with other crops, is proceeded with until the growth of foliage renders the operation no longer practicable.

On dairy farms it is usually found most convenient to cut the maize daily as required, during August and September, carting it out on to the pastures for the cows after milking, when, if the crop has been grown closely in the rows, the whole of the stem will be sufficiently succulent to admit of its being entirely consumed. The mistake made by many growers is to allow the circulation of too much air and light around the plants in the rows, with the result that portions of the stem of from 2 to 3 feet in length become hard and fibrous, and are left unconsumed on the pastures. An average yield of green fodder is from 20 to 25 tons per acre.

Maize may be used successfully for ensilage, and where the crop yields as much as 40 tons per acre of succulent herbage a large quantity of material has to be dealt with. For ensilage the crop should be cut before the base of the plant becomes hard and woody, otherwise difficulty will be experienced in severing the stems in the chaff-cutter, to which it is carried straight from the field and then dropped as cut direct into the silo. Good silage can be produced by relying on the weight of the fodder itself to provide the necessary pressure, assisted by simply trampling it down. Silage stacks are sometimes used, but are not advisable, owing to the detrimental influences of the atmosphere upon the outsides. The preservation of the crop, however, either in silos or stacks, is never so satisfactory as feeding it in the green state.

Green maize is much richer, weight for weight, than root crops, containing as it does only 70 to 80 per cent of water, or 20 to 22 per cent of solids, which is double the amount contained in roots. If cut when young and succulent the percentage of digestible carbohydrates and proteids constitute about 14 per cent of the total solids, the remainder being fibre, although not altogether indigestible. It provides excellent fodder for milch-cows, a yield of 20 tons per acre supplying a herd of twenty cows with the greater portion of their ration for a fortnight. It follows vetches, rye, and other green forage crops, and precedes cabbages, turnips, and root crops. It is also relished by horses, sheep, and pigs, and is especially useful for breeding sows.

Although maize is undoubtedly most acceptable in dry seasons, it is nevertheless valuable on any dairy farm where grass is scarce, and as a substitute for grass when there is no other green fodder to take its place. It is chiefly deficient in protein and mineral matter, as the following analysis shows, and therefore does not draw the land, as is sometimes thought.

	Dry Matter. Per cent.	Oil. Per cent.	Protein (Nitrogen × 6.25). Per cent.	Soluble Carbo- hydrates. Per cent.	Fibre. Per cent.	Ash. Per cent.
Maize . . . .	15.09	.22	1.58	8.39	3.93	.97
Pasture Grass	23.3	.9	3.9	10.9	5.2	2.3

**Prickly Comfrey** has been much recommended as suitable for small patches of land, inconvenient for ploughing. The bed is thoroughly worked and cleared of weeds, and the "sets" are planted in rows 3 feet apart each way, and kept clean and cultivated between. It produces several crops during the season, and may be regarded as perennial. The herbage has, however, been pronounced to be watery, and the cultivation does not extend in this country. It is difficult to eradicate when the land is required for another crop.

## CHAPTER X.

### GRASSES, MISCELLANEOUS PLANTS, AND WEEDS.

GRASSES are a well-defined group of plants in which the floral envelopes are modified as pales and glumes, and arranged on spikes or panicles, and they have even been regarded as degenerate lilies. They are endogenous and monocotyledonous, and their venation or veining is lineal instead of reticulate. To the agriculturist they are less definite, for he speaks of cow grass, which is perennial red clover, marl-grass, which is a form of *T. medium*, and a crop of "grass", which is really a mixture of many plants comprising different orders.

The grasses are more widely distributed than any other class of vegetation. They cover wastes, ascend mountain summits, and obtrude themselves everywhere. They may indicate neglect and desolation, but nevertheless render the earth beautiful. Most of them are enemies to cultivation, and they thrive best as permanent pastures, meadows, or open downs. They comprise a very large number of species adapted for every description of soil and climate, from the Equator to the Poles. Many are perennial, and those which are not are abundant seeders and therefore equally persistent. They propagate by seed, roots, and underground buds and branches, and figure largely both as weeds and as crops.

Cultivated Grasses include cereals, maize, rice, millet, panicum, sorghum, sugar-cane, kaffir corn, etc., all of which have been developed from wild progenitors, although in some cases, as in wheat, their pedigree is difficult to trace. These cultivated grasses are capable of great improvement, and readily produce new varieties. They possess the property of transmitting newly observed or acquired peculiarities to their progeny, and this tendency seems to be favoured by their method of self-fertilization, which takes place within the pales and glumes independently of transported pollen or of insects. The persistence of new varieties of cereals is a remarkable fact, especially as they are propagated from seed.

Having already noticed cereal cultivation, it remains for us first to consider briefly that of the fodder cereals, and the few other grasses which are grown on tilled land, in rotation with other crops.

The Fodder Cereals include winter barley, winter oats, and rye, all of which may be grown as corn crops. They form a group by which a succession of green food may be produced, lasting through at least two months of the spring, forming a bridge between the end

of the root-feeding season and the advent of summer keep. Rye is our earliest green food, as it may be ready for use, in mild and open winters, in January, if sown early in the previous year. It is, however, most commonly available in March, and is followed by winter barley, and lastly, by winter oats. By the sowing of early and later rye and the two other cereals named, it is easy to provide successive folds until trifolium and vetches follow as spring and summer keep. In this way the fodder cereals occupy an important position in the cycle of foods which last the entire year. These crops are all better fed off before they shoot into stems or straw, as they then begin to be tough and less nutritious ; and after the land

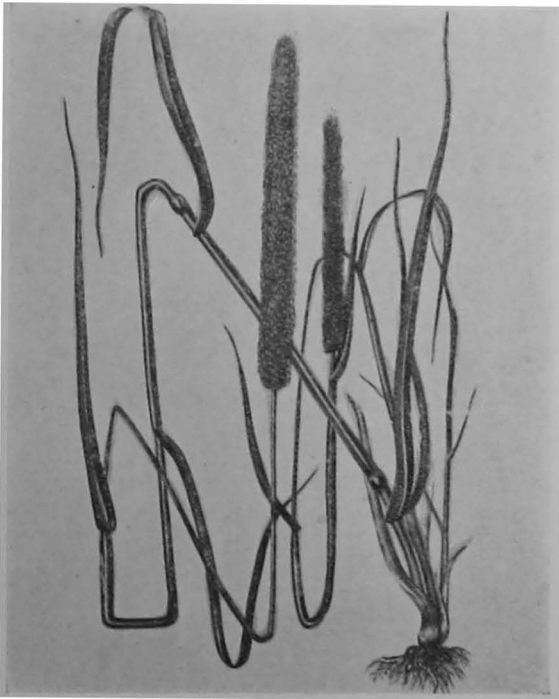

FIG. 46.—Timothy or Cattail (*Phleum pratense*).

is cleared it is broken up for roots. They therefore occupy the root or fallow breadth, and in this respect differ from the grasses yet to be mentioned, which are cultivated in the third year of the four-course rotation.

**Rotation Grasses** differ from permanent grasses in doing best upon cultivated ground, as is shown by their producing maximum yields during their first year's growth. Old "seeds" are never so luxuriant as young lairs, and after the second or third year they are apt to become sparse and threadbare, and require to be broken up. The permanent grasses are very different ; for newly laid



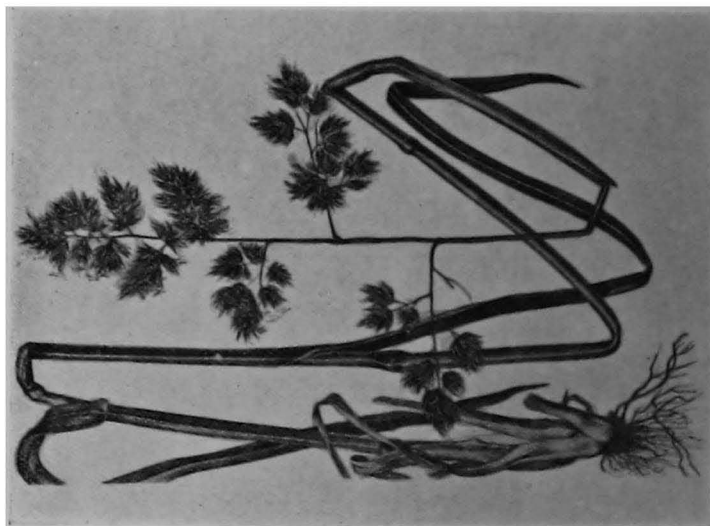

FIG. 46.—Rough Cock's-foot (*Dactylis glomerata*).



FIG. 47.—Meadow Foxtail (*Alopecurus pratensis*).

pastures, although in some degree following this order, begin to improve after their third or fourth year, and very gradually to assume the form of permanent grass land. They prefer a firm and undisturbed soil, but at the same time carry out their own system of tillage by root action, and the accumulation of organic remains, in which they are assisted by earthworms. Among the best-known rotation grasses is *Italian rye-grass*, which is largely imported from Lombardy and Northern Italy. The foreign seed is often both dusty and "dirty", i.e. infested with darnel, couch, and soft-brome grass, but is considered more vigorous and bolder in foliage than English-grown seed.

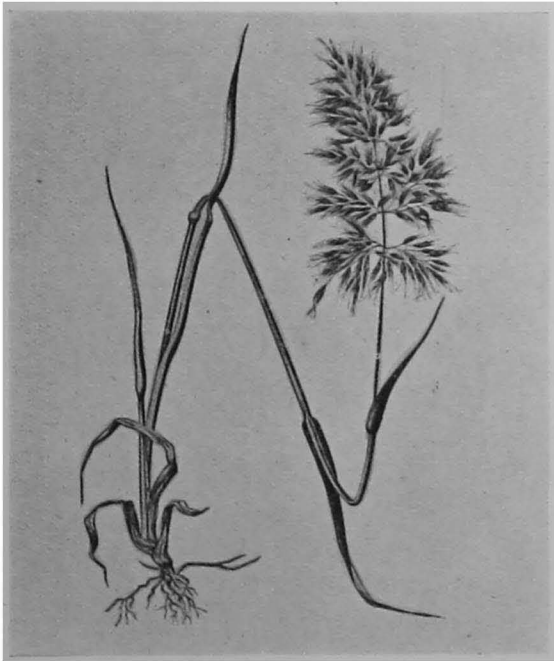

FIG. 49.—Yellow or Golden Oat-grass (*Tresetum flavescens* or *Avena flavescens*).

The plant is described as a perennial of short duration, and where sown on sewage farms, or with a view to maximum production, is sown every year. It is capable of yielding 70 tons of green fodder per acre in successive cuttings; and the united lengths of all the mowings laid end to end has been known to exceed 13 feet. One cutting measured on a sewage farm by the writer measured over 7 feet from the stubble to the tip of the stem, and many reports have been published as to the wonderful weights produced under irrigation. Heavy crops may also be produced with the aid of successive dressings of nitrate of soda, applied between the cuttings. Italian rye-grass forms a part of most ordinary mixtures of "grass seeds" for mowing,

and if the land is not clover-sick a mixture of 1 bushel of this grass and 14 lb. of red clover is difficult to beat as to productiveness. If sown alone, 4 bushels per acre is a full seeding which is often used. Others recommend 2 to 4 bushels, and much must depend upon the weight and reliability of the seed.

Italian rye-grass is, however, considered by many to be detrimental to the succeeding wheat crop, partly because of its similarity in habits of growth, and partly because many farmers believe that it makes the land foul. This is, however, a libel, and the idea has no doubt arisen through the foulness of imported seed. Clean samples



FIG. 50.—Chicory (*Cichorium Intybus*).

should be bought, and a slight knowledge of agricultural botany will enable any farmer to recognize the seed, and distinguish it from the above-mentioned weeds, or the unawned perennial variety.

In order to provide for two or three years duration, the best plan is to use a mixture composed half of perennial rye-grass and half of Italian.

**Chicory.**—Chicory (*Cichorium Intybus*) (Fig. 50) is one of the most easily recognized plants of the Compositæ family, owing to its azure-blue flower-heads. There are several varieties, notably Large Brussels

or Whitloof and Red Italian, both of which are large-rooted and are grown for the manufacture of coffee chicory. Chicory is also grown in many gardens for salading, the roots being gently forced, and the leaves blanched, much in the same way as sea-kale. In many parts of Hampshire it is largely cultivated by some of the most renowned flockmasters, who fold sheep on the crop. It is readily consumed with the exception of some of the tougher flowering stems.

It makes a prolific growth on all classes of land, and especially on poor soils of a chalky or sandy character, into which the roots may penetrate to a depth of 3 feet. It also has the advantage of providing an important change in the cropping of clover-sick land.



FIG. 51.—Sweet Vernal Grass (*Anthoxanthum odoratum*).

When grown as a forage crop, from 10 to 12 lb. of seed are broadcasted per acre ; and the plants, when firmly established, yield two or three heavy cuts of green fodder during the year. It is also used in grass mixtures at the rate of about 3 lb. per acre on soils which are benefited by the growth of deep-rooting plants.

**Mixtures of Rye-grass and Clovers.**—For one year, as already mentioned, red clover and "Italian" will yield an abundant hay crop ; but to avoid the risk of failure of the red clover, it is usual to construct a mixture of about 1 bushel of Italian rye-grass, 8 lb. of red clover, 2 lb. of alsike, and 6 lb. of trefoil. This is a sufficient

seeding per acre, but it is well to err on the side of a plentiful seeding. The quantity of clover or small seeds sown varies from 11 to 15 lb. per acre, and when sown without rye-grass 28 lb. may be used. Italian rye-grass is sometimes found to overpower the clovers; and to correct this tendency some farmers sow only  $\frac{1}{2}$  bushel of mixed rye-grass with their clover seeds.

For mixtures to last two, three, or more years rather more seed and more complicated mixtures are prescribed, of which the following is a fair sample:—

	lb.	
Italian rye-grass . . . .	5	(18-20 lb. per bushel).
Perennial rye-grass . . . .	8	(30 lb. per bushel).
Timothy grass . . . . .	2	
Cock's-foot . . . . .	5	
Smooth-stalked meadow grass	2	
Rough-stalked meadow grass .	2	
Red clover . . . . .	2	
Perennial clover . . . . .	2	
Alsike clover . . . . .	2	
White Dutch clover . . . .	1	
Yellow clover . . . . .	4	

---

35 lb.

It should, however, be understood that this is merely a typical mixture, suitable for a large number of soils, and that various grasses and other herbaceous plants are recommended for special soils and situations. The variations in mixtures are very great, and the student should refer to the many excellent catalogues issued yearly by leading firms of seedsmen, and also to numerous encyclopædic articles on the subject, as well as to textbooks.

The literature of grass seeds is very voluminous, and to give an adequate idea of mixtures suitable for short, long, or permanent duration would fill many pages. Professor McAlpine's able and exhaustive papers upon "Grasses" and "Pastures", the "seeding, formation, and management of", in the *Standard Cyclopædia of Modern Agriculture* are well worthy of study; but a treatise on grasses would carry the authors of this small work far beyond its prescribed limits.

The suitability of certain species of grasses for dry and arid situations, or for low-lying and damp land; for deep and shallow soils; for plantations; for lawns and pleasure-grounds such as golf links and tennis courts; for orchards; for rabbit warrens; for mossy or peaty soils; for sheep pastures, or for bullock grazing, etc., are all important considerations which sometimes overlap each other, and there is some danger of over complication; and it is curious to notice in this connexion the spontaneous and natural origin of many of our best pastures.

The Sowing of Hay Seeds has been recommended as a means of solving the difficult question as to the most appropriate mixtures, and, certainly, a study of the existing grasses on local pastures

assists materially in selecting suitable species for seeding new land. The objections to using hay seeds consist in the presence among them of undesirable seeds, and also the different dates of maturation of the constituent grasses when cut. A botanical examination by an expert based on the prevailing grasses might, however, lead to a selection of seeds from a good seedsman whose advice would be of great value.

It is also well known that the quality of all grasses as foods depends to a great extent upon the land which produces them. Even grasses which are regarded as decidedly inferior are known to compose a considerable proportion of certain first-rate feeding grounds, and



FIG. 52.—Crested Dog's-tail (*Cynosurus cristatus*).

there is no absolute certainty as to the relative feeding value of grasses produced under different conditions of soil, season and climate. The whole subject of laying land down to grass is beset with difficulties, and on the top of these comes the fact that many excellent pastures are known to have "fallen down" to grass by mere abandonment.

Thousands of acres of good, sound, grass land, bearing traces of arable cultivation in the form of rounded ridges and open furrows, must have arrived at their present excellence during a long period of years. It is also noticeable that road scrapings and heaps of soil

become covered with grassy herbage in a comparatively short time, without artificial seeding; and that some classes of land take to grass naturally without assistance, while it is practically impossible to produce a turf upon others.

The principal aim in laying arable land down to grass is to bridge over the period which seems in most cases unavoidable, between sowing and the production of a sole or sward of good grass. In some cases there is no difficulty, while in others, twenty years is not sufficient for the purpose.

**Rules for securing a good Plant of Grass.**—It has long been held that land should be in high condition when it is sown down with



FIG. 53.—Perennial Rye-grass (*Lolium perenne*).

perennial grass seeds, and this is indicated by the fact that old pasture ground is generally richer than adjoining arable land. Grass requires a high nitrogen content in the soil, and permanent pastures tend to accumulate soil nitrogen. A luxuriant growth of rotation grasses and clovers is always an indication of richness in land, and the same condition favours the development of permanent grasses. It is for this reason that sowing without a (corn) crop on land upon which roots have been close-folded so often succeeds. The seeds may then be sown in August (after rape or cabbage) and although they may become infested with annual weeds, these will disappear during winter, or be cut down, never to appear again, at the first mowing.

Another hint worthy of attention is to allow newly sown seeds to develop, without grazing, during their first spring, and to turn cattle out upon them when they are almost fit to mow. This may appear wasteful, but is less so than it seems, as store cattle will eat down the rough herbage before the succeeding winter. By this system, which was practised by the late Sir John Lawes at Rothamsted, the young grasses develop, and there is no removal of a hay crop. There is also a saving of labour, and the grass plants become firmly established. Mowing the first year has always been recommended in preference to grazing; but the above method securing the advantages of full development of the grass plants, without robbing



FIG. 51.—Italian Rye-grass (*Lolium italicum*).

the land by removing the hay, does away with the necessity of applying a dressing of yard or other manure.

That land ought to be clean as well as in good heart when laid away to grass is true, but it is more important that it should be enriched than entirely freed from weeds. Couch soon dies out of pasture land, and arable weeds find it difficult to flower and seed upon it. If, for example, land is sown with grass seeds in August, the field may present a rough appearance before winter, but the clover and grasses will persist, while the charlock and other weeds will die down. The first mowing completely obliterates them, and the grass



particular species, which elbow out their rivals, on the principle of the survival of the fittest. They seem to show that the selection of seeds is not any more important than liberal treatment subsequent to sowing, and the encouragement of the best grasses later.

**The Migrations of Seeds.**—The appearance of grass in all kinds of situations such as roofs, ledges of rock, paths, pavings, crannies, etc., shows clearly that the seeds are carried in the air. Disused roads soon become green lanes, and neglected gardens speedily become overgrown. The rapidity with which heaps of earth are covered with grass has already been mentioned, and the conclusion is unavoidable



FIG. 58.—Wood Meadow Grass (*Poa nemoralis*).

that the tendency of all grasses is to invade unoccupied spaces. The seeds pass through the digestive systems of birds, and of larger animals, and are carried by water and wind, and possibly by clouds. They also exist in soils in great numbers, as is shown by the appearance of seedlings in mould of any kind. They lie dormant for considerable periods, and their germination may be delayed or accelerated by certain conditions. They show decided partiality for some soils, and in some cases will not appear at all. The writer has known several pounds of foxtail seed sown per acre, and yet not a single stem could be seen two or three years later.

All these facts show the difficulty of accounting for the composition of mixed herbage. Also that the compounding of suitable mixture is not everything. They explain why good permanent pastures develop from ordinary mixtures of clover and rye grass, intended to last for only two or three years. Still, it is always advisable to sow a well thought out mixture, in which such robust grasses as Cock's-foot, Cat's-tail, Foxtail, Meadow grasses (*Poa pratensis* and *trivialis*), tall and other Fescues, etc., are blended with white, alsike, red, and yellow clovers, and small quantities of milfoil, bird's-foot trefoil, kidney-vetch, and other herbs. The framing of permanent pasture mixtures is purposely omitted from these pages, because of their



FIG. 59.—Meadow Fescue (*Festuca pratensis*).

endless variety, and also because so many are given in other publications.

**Effect of Seasons and Climate.**—Pastures respond to both seasons and climate. Droughty summers, and drainage, cause water grasses to die out, and the natural herbage of high lands adapts itself to the climate.

A little observation will show that the predominating grasses vary with situation, so that the bents of Crested Dog's-tail appear in one place, Cock's-foot in another, Soft Brome in a third, a meadow barley in a fourth. These grasses were not sown, but have established

themselves, and become features. It is the same on water-meadows, for there, Floating Meadow Grass, Yorkshire Fog, Tall Fescue, Carex, Floating Foxtail, and various species of Rush, Flag, and Sedge will be found. It is a common experience that sown grasses often die out, and others (sometimes less desirable) take their places.

**Difficulty of Laying some Land down in Grass.**—That natural downs are difficult to reinstate is well known. In dealing with such soils it is much better to improve the existing herbage by close folding and manuring than to break up and attempt to sow new pastures. The usual course of events is, a fair crop of mixed seeds the first year, followed by rapid deterioration, until putting the



FIG. 60.—Tall Fescue (*Festuca elatior*).

land through a rotation of crops seems to be the only alternative to waste ground. The same is true on many heaths and hills which once afforded a sweet permanent pasturage. Such lands appear impossible to again lay down in grass, but the case of fertile clays, deep alluvial loams and red lands, is different, as they often take to grass as naturally as ducks to water. Poor clay soils are, however, difficult to convert, and sometimes remain in a condition of poverty for twenty years, after seeding with the most approved mixtures.

**Effect of Grazing and Basic Cinder.**—Cattle-grazing is said to improve grass land, while sheep grazing is trying, especially to newly-laid

fields. Probably no grass land, however poor, can help improving under a system of grazing, in which cake and purchased foods are eaten upon the land; and in the present conditions of agriculture this method is to be highly recommended. It takes advantage of an established herbage, and avoids the long interregnum between sowing and the formation of a sod resting on vegetable mould. It may be adopted on a large class of poor, cold, clay soils, and basic cinder applied at the rate of 5 cwt. per acre will be of great assistance in bringing up clover, and refining the quality of the herbage generally. It will, however, be observed that pastures that are liberally manured by cake-feeding or applications of dung, may develop rankness of



FIG. 61.—Hard Fescue (*Festuca duriuscula*).

herbage, whereas after dressings of basic slag, super, and other mineral manures, the stock graze much closer to the ground. This is well worthy of attention.

**Summary as to Laying down Land to Grass.**—It may have been thought in the previous observations that the mixture of seeds used, and the necessity of absolute cleanness of the land have been relegated to a secondary position. Such is, however, not the opinion of the writer, for it is highly desirable, in order to bridge over the critical period, that the best possible mixture should be used, and that the young grasses should be free from rivals. Final success,

however, does not entirely depend upon either of these factors, but rather upon the land, and the treatment of the newly laid down pasture.

**Grass v. Arable Land.**—Agriculturists are accused of laying down land to grass, on the ground that it is a restoration to the prairie—an abandonment of agriculture, a shirking of intensive cultivation, and therefore of maximum food production. These are favourite themes with those who blame our landlords and farmers, and it is quite possible to imagine a condition of things in which arable cultivation may be resumed on many fields now in grass. It is also possibly true that even the poorest land might be cultivated to a profit under



FIG. 62.—Yarrow or Thousand-leaf (*Achillea millefolium*).

certain conditions. It is, however, equally true that whether agricultural or pastoral methods are employed, owners and occupiers must work for a profit, and not on purely philanthropic principles; and as long as this is the case both parties will naturally ask whether a particular field will pay better as arable land or as pasture.

The tendency of late years has been towards grazing, in a great measure on account of the rapid rise in importance of the dairy industry, and the increasing popularity of live stock. It is no doubt true that arable land can maintain more live stock than grass land; but, after all, the net result is the point, rather than the gross return,

however, does not entirely depend upon either of these factors, but rather upon the land, and the treatment of the newly laid down pasture.

Grass *v.* Arable Land.—Agriculturists are accused of laying down land to grass, on the ground that it is a restoration to the prairie—an abandonment of agriculture, a shirking of intensive cultivation, and therefore of maximum food production. These are favourite themes with those who blame our landlords and farmers, and it is quite possible to imagine a condition of things in which arable cultivation may be resumed on many fields now in grass. It is also possibly true that even the poorest land might be cultivated to a profit under



FIG. 62.—Yarrow or Thousand leaf (*Achillea millefolium*).

certain conditions. It is, however, equally true that whether agricultural or pastoral methods are employed, owners and occupiers must work for a profit, and not on purely philanthropic principles; and as long as this is the case both parties will naturally ask whether a particular field will pay better as arable land or as pasture.

The tendency of late years has been towards grazing, in a great measure on account of the rapid rise in importance of the dairy industry, and the increasing popularity of live stock. It is no doubt true that arable land can maintain more live stock than grass land; but, after all, the net result is the point, rather than the gross return,

and, so long as landlords and occupiers see a better net result from grass than from arable cultivation, so long will grass land retain its position. There can be little doubt that, over wide areas, a good pasture is at present of greater value than an arable field of similar quality.

## FLAX.

THE cultivation of flax is fairly extensive in Ireland, and a considerable amount of attention has been paid to the methods of cultivation, manuring, etc., by the Department of Agriculture in that country. The chief drawback to flax cultivation in our own country is that it requires such a large amount of hand labour in the final stages of its production, and this labour is generally wanted when harvest work is in full swing. The success of some of the British flax growers no doubt is due to the superfine quality of the fibre they produce, which is in every way superior to that which is imported.

Flax was originally grown for its fibre alone, but later the value of linseed for cattle was discovered, and some farmers grow it specially for this purpose. The plant may be put to many uses, the seeds being specially valued as a source of oil, and the fine fibre which is contained in the "liber", or inner bark, for spinning. The short tangled fibre contained in the other portions of the stem is used for making small ropes and cords. Similarly, the coarse "tow", which consists of the shorts, is used for stuffing the cushions and backs of carriages, and also for making coarse cloth, ropes, etc.

Flax (Fig. 63) is an annual, and when the ovary or lower part of the pistil ripens, it develops into the boll or seed-vessel. When fully developed, each boll contains ten seeds enclosed in separate carpels. These seeds are smooth, and coated with mucilaginous cells; linseed oil is extracted from them by pressure, and the residue is pressed into cakes which are largely used in cattle feeding. Flax seed yields about 23 to 27 per cent of oil, and the cake generally contains from 8 to 10 per cent.

Good loamy soils are best, but satisfactory crops can always be secured from any soils which can produce good crops of cereals. Waterlogged soils, and those which contain an excess of moisture, and very light sandy soils, are unsuitable for the crop. Generally, flax follows roots which have been liberally dressed with farm-yard manure, and it is not advisable to apply dung directly to the flax crop. In Ireland, a common rotation of crops adopted in the chief flax-growing districts is, oats after lea, roots, oats, flax (with clover and grass seeds), seeds hay, pasture, and possible pasture again. Flax should not be grown oftener than once in five years on the same land. If "roots" are grown after flax the land should be heavily manured, and even then the root crop will show to disadvantage.

Reliable flax seed for sowing is not very easy to obtain. The best kinds are the Dutch (Riga Child) and the Russian (Pernau Crown), and April and May are the usual months for sowing. It is better to err on the side of thickness as regards the quantity of seed used, as thickly-sown flax grows straighter and more uniformly in

length than when thin sown. A proper seeding should produce plants that form no branches near the roots. Practically the only manures used for the flax crop are of potassic nature; nitrogenous fertilizers not being desirable as they cause the plants to run up too high, and the fibre suffers in quality. The harvesting and scutching of flax are important, and entail a great deal of hand labour; generally the plants are pulled as soon as the bolls are turning from a green to a light-brown colour, and the seeds inside are firm and of a brown hue. The flax is then rippled or combed out, so that the bolls fall to the ground, or into a receptacle, and are subsequently reduced into a meal, and the chaff may be separated

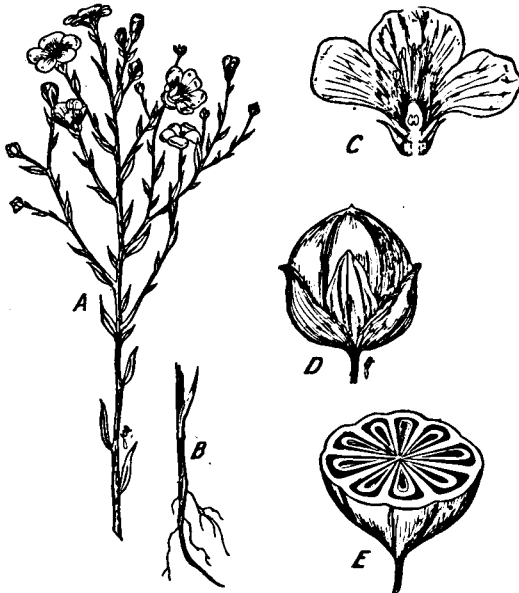

FIG. 68.—Flax (*Linum usitatissimum*). A, B, flax plant; C, flower; D, fruit or boll; E, section through D.

by sieves or a winnowing machine, leaving the linseed behind. Flax stems are set up in sheaves, and left for a few days before "retting", or watering, in soft river water. Finally, as soon as the fibre shows a tendency to detach itself from the woody part of the stem of its own accord, often tested by wrapping it round the fingers, it should be taken out of the water, left for an hour or so on the bank to drain, and afterwards carted out to a field and spread out to dry as thinly as possible. This is "retting" and prepares the way for scutching or separating the fibre from the enticle part, or bark, which is the final operation, so far as flax growers are concerned.



## TOBACCO.

The cultivation of tobacco in this country has during the last four years attained considerable importance. Its cultivation in Ireland is of older standing, largely owing to the effort of Colonel N. Everard. At present Hampshire appears to have the largest area under cultivation, but there are enthusiastic growers in Norfolk, Suffolk, Lincolnshire, North Wales, and Scotland, and the total area cultivated this year is stated to be 130 acres in England alone. The Tobacco Growers Society is actively engaged in promoting the cultivation, and has been entrusted with a grant from the Development Commissioners. What is more important, financial aid is promised to growers to defray working expenses, and loans for the erection of portable curing barns and other equipments. Although at first the idea was to grow coarser varieties, suitable for insecticides and fumigation,



FIG. 64.—Tobacco plant (*Nicotiana tabacum*).

growers are now much more ambitious, and material for cigar wrappers, cigarettes, and smoking mixtures is being attempted with some success.

Nicotine largely enters into the composition of insecticides, and, in view of this fact alone, there is every reason to believe that it would pay the grower to cultivate tobacco for this purpose, as it could be done without payment of duty.

Tobacco (Fig. 64), like the potato and tomato, belongs to the natural order *Solanaceæ*, and *Nicotiana tabacum* and *N. rustica* are the two species commonly met with in cultivation. Varieties of the former species produce the best grades, while with *N. rustica* are associated inferior qualities, although the proportion of nicotine is high. It is therefore to this latter species that the English farmer may need to turn his attention for the production of nicotine for

commercial purposes. The growth of smoking tobacco is also being encouraged, and especially of leaves suitable for cigar wrappers.

**Manuring.**—The cultivation is comparatively simple, and if the soil is in poor heart it must be liberally manured as for mangels, as much as twenty loads of well-decayed farm-yard manure being ploughed in on retentive soils in autumn, or in early spring on those of a light and porous character. This dressing may be supplemented with from 3 to 5 cwt. of superphosphate per acre and 1 cwt. of sulphate of potash at the time of working down the ground in spring, while when the plants have become established a dressing of 2 cwt. of nitrate of soda per acre in three applications at intervals of three weeks will prove beneficial. Other nitrogenous, phosphatic, or potassic manures may be substituted in keeping with the nature of the soil, but salt, or manures like kainit containing a large excess of chlorine or other impurities, are undesirable.

**Raising Seedlings.**—As the crop is a transplanted one and liable to injury from frost, the seedlings should be well advanced and ready for transplanting by the end of May. Those who are inexperienced in the sowing of very fine seeds would do well to consult a gardener, most of whom have had practice in sowing small seeds like begonias or even fern spores.

Sowing takes place from the middle to the end of March, as if sown too early the plants, like tomato seedlings, are apt to starve before being placed in their permanent quarters. One ounce of seed will usually sow 100 square yards of seed-bed, and will provide sufficient plants for an acre of ground (*vide* p. 133). Some growers raise the seedlings in boxes and transplant into frames, but whatever practice is adopted the plants must be kept close to the light, and given an abundance of air, so that they may be thoroughly well hardened previous to their removal to the open ground. They may be transplanted with either a dibble or a trowel, selecting a dull moist day for the operation, as otherwise watering will be necessary as the work proceeds.

**After Cultivation.**—If, as is sometimes possible on easily worked loamy soils, weed seeds are allowed time to sprout and are then destroyed by light harrowing, the expensive operation of hoeing will be avoided to a large extent. If a light roller is passed over the land the rows can be plainly marked out with an ordinary drill with the coulter well weighted, so that the plants will occupy the angles of a number of small squares. To facilitate hoeing the plants may be planted from 24 to 30 inches apart each way, according to the quality of the soil.

As leaves, and not seeds, are the object of cultivation, the flowering shoots must be removed by "topping", which is best done when the first flower is about to open. The removal of these primary shoots gives rise to secondary growths in the axils of the leaves of the main stem, which if allowed to grow would weaken the plant, and these must also be removed. In fact, this process of "disbudding" must be continued at intervals of ten days as the cultivator's object is to allow each plant to develop and produce from nine to twelve leaves, so placed as to admit of their becoming well ripened.

**Harvesting.**—The leaves do not all ripen at once, and in the case of smoking tobaccos the careful picking of the leaves as they ripen, from the ground upward, is a matter entailing considerable care and expense; but in the production of nicotine for commercial purposes it becomes necessary to remove the whole plant when the middle leaves are ripe, as then the greatest economy will be ensured. All suckers must be removed before cutting, otherwise the young shoots will continue to grow for some weeks after the crop is harvested. The plants should be dry and free from dew when cut, and a sunny day is a great advantage, as the leaves, if left for an hour or two, will wilt, and thus be less liable to injury from handling. The customary plan is to tie or spear from six to nine plants to a stout stick or lath about 5 feet long. The sticks, with plants attached, are then carefully removed to the drying sheds, and placed on horizontal supports, the plants hanging head downwards. The drying shed should be so constructed as to admit of a brisk and free circulation of air between the poles, and drying will then be completed in from six to ten weeks.

The nicotine may be readily dissolved out from the dried leaves in cold water at the rate of 1 gallon of water to 1 lb. of leaves each day for three days. The quantity of nicotine in the leaves may average about 4 per cent, and in most cases this will be found to be a reasonable estimate.

From careful experiments carried out at Wye College it would appear that the approximate cost of cultivating the crop is about £27 per acre, and assuming that 100 lb. of nicotine is obtainable per acre the value of which commercially may be estimated at 15s. per lb., i.e. £75, this would give a return of £48 per acre. These figures, however, must only be regarded as approximate, and, apart from this, the grower must also take into account any restrictions and duties that may be imposed by the Commissioners of Customs and Excise. Recent demonstrations on Mr. Brandon's Estate at Church Cookham, Hants, proved extremely encouraging, and in his case the costs of cultivation were found to be about £30 per acre, and the expected profit at least £7 per acre.

#### SEED-TESTING.

The question of seed-testing should be studied by every practical farmer, as the annual expenditure in the purchase of seeds on many farms is considerable. However good the land, and the season of sowing, satisfactory results cannot be ensured unless seed of high quality is sown. At the present day seed-cleaning machines have attained to such a high state of efficiency that the chances of receiving adulterated or impure samples of seed are less than they were years ago, when there was less competition amongst seed merchants. Retailers of seed usually depend upon the larger merchants and wholesale houses for their supplies, and those who have visited these important establishments must have been impressed by the ingenious devices for the eradication of all impurities and defective seeds. Moreover, germination tests are carefully carried out before the

seed is put on the market. Farmers and gardeners, however, sow large quantities of home-grown seed, and it is in such samples that one usually encounters impurities and low germinating power.

Bad harvesting conditions are also a cause of imperfect germination, a point which is often overlooked when regulating the quantity of seed per acre. For example, in special circumstances, it may be necessary to sow as much as 6 bushels of oats per acre in place of the customary 4 bushels.

The importance of having all seeds tested scientifically, and under uniform conditions, is well demonstrated by the fact that they are by far the most variable material the farmer has to purchase, and, notwithstanding the improved methods of selection, they are weight for weight the most expensive.

The success or failure of clovers, grasses, and possibly of the succeeding crop also, may depend entirely upon the quality of the grass seeds sown; and there are numerous factors which affect their quality, as for example the system of culture employed, the conditions of harvesting, the method of cleaning and storing, etc. Small seeds, like clover, cannot be harvested without the intrusion of seeds of weeds. By screening processes the seeds of the much dreaded dodder can be removed, but those of the cut-leaved *Geranium* in red clover, or sheep's sorrel in white clover, are difficult to separate without removing much of the best of the clover seed. Grass seeds grown as pure crops will invariably contain seeds of other grasses, and often an abundance of useless chaffy material difficult to eradicate from the sample. The presence of these impurities will therefore decrease the value of the bulk proportionately. Some grasses, such as meadow fescue and sweet vernal grass, are often gathered by hand, but even this does not wholly do away with the trouble.

The Ripeness of the Seed at the time of harvesting is another important factor. In very many cases it is impossible to obtain a uniform degree of ripeness, as an example of which the common oat may be cited. In a partially ripened seed the embryo may exhibit signs of activity when sown, or it may be incapable of germination, but rarely does it give rise to a seedling of normal growth. Well-developed and mature seed is often seriously damaged by rain before and after cutting, and in bad seasons there is always much "weathered" seed on the market, and all farmers should test their samples before deciding upon the quantity to sow.

The Age of the Seed.—There are many seeds which improve by keeping, as for example those of the melon and cucumber, which produce stronger plants at two years old than when sown earlier; and old vetch seed is preferred by many growers. The writer has been able to record some interesting experiments in this connexion with tropical seeds, but these, of course, do not concern British agriculturists. It will suffice to say that the longevity attributed to mummy seeds, such as Job's Tears (*Coix lachryma*), has been considerably exaggerated. Vitality is to some extent influenced by the method of storing, but in nearly all cases seeds containing an excess of oil lose their vitality quicker than others, with the exception of charlock. Generally speaking seeds should not be kept more than

two years, and even then they will seldom be found to have a high speed of germination.

Seeds are often injured by the process of threshing, as instanced in too closely hummelled barley, and maltsters dislike such samples on account of their inferior germinative power. Insect pests, especially weevils, are another common source of injury to seeds, as in the case of the bean weevil. The irregularity in the germination of mangel and turnip seed is doubtless often attributable to old and new seed having been mixed. For these and other reasons which cannot be fully entered upon, reliable tests should be carried out from time to time.

The Object of a Seed Analysis is not solely for the purpose of estimating the monetary value of any particular sample, although this is undoubtedly of great importance, but also to discover the real value or worth of the seed for the purpose for which it is procured ; or to determine whether it is reliable seed, quite apart from the question of cost. All practical agriculturists should understand an analysis, and be able to deduce the desirable characteristics of any sample analysed. The mere statement of the percentage of pure seed present is in itself insufficient, and alone might be misleading. Standards of purity have been fixed, and it is assumed that if the samples come up to these that they are satisfactory ; even if this is the case it does not follow that the purity of such samples is always satisfactory. A sample of red clover may be of 90 per cent purity and be classed as satisfactory, while another sample of red clover might contain 99 per cent of pure seed, and yet be unsatisfactory, solely owing to the nature of the impurities present.

Impurities are of different kinds; they may be dead and harmless, such as earth, sand, stones, chaff, leaves, and flower stalks, or they may comprise seeds of plants either useless or positively harmful.

Cheap samples of mangel seed, for example, may contain a large proportion of woody stems, soil, grit, and other impurities, showing that the seed has not been thoroughly dressed or cleaned, and it is at once apparent that their presence will depreciate the value of the bulk. It sometimes happens that impurities exist in the form of seeds more costly than those comprising the bulk, as for example a small percentage of perennial red clover or meadow fescue, in a sample of tall oat grass. This would rather enhance the value of the sample, and, at any rate, the presence of such impurities can be in no way harmful. Black-medick seed, in samples of red clover or lucerne, would be less desirable, not only on account of their lower commercial value, but more particularly because of the smaller value of the plant produced. When a considerable quantity of yellow suckling clover occurs in white clover, or perennial rye-grass in meadow fescue or meadow foxtail, the value of the bulk would again be depreciated. The use to which the seeds are to be put will influence the depreciating effects of such impurities.

It is usually with the presence of weed seeds that the farmer concerns himself, and it is to be regretted that many small-holders are not sufficiently careful in this respect. For example oats and other cereals are frequently sown which contain a host of injurious

weeds, including wild oats. A sack of seed corn should always be turned out on delivery on to a rick cover or other suitable place and fully exposed to the light, and if on examination it is found that it has not been thoroughly well cleansed, it should be promptly returned, as it is only by taking such stringent steps that land can be maintained in a clean condition. It is difficult for many people to realize that the sowing of 1 per cent of weed seed may result in the financial failure of a crop, and also involve many additional expenses in tillage. This cannot be too forcibly impressed upon beginners, and for that reason we quote the following useful table published by Mr. S. F. Armstrong in vol. xix of the *Board of Agriculture Journal*, No. 10.

Table showing what "1 per cent by weight" of some common weed seeds represents, when stated as approximate number of weed seeds per lb.

Species of Weed Seed.	Approximate number of seeds in 1 lb. of seed as purchased.
Creeping Buttercup ( <i>Ranunculus repens</i> ) . . . . .	2,900
Red Field Poppy ( <i>Papaver rhœas</i> ) . . . . .	40,000
Charlock ( <i>Sinapis arvensis</i> ) . . . . .	1,980
Shepherd's Purse ( <i>Capsella bursa-pastoris</i> ) . . . . .	45,000
Field Pansy ( <i>Viola tricolor</i> ) . . . . .	6,700
Chickweed ( <i>Stellaria media</i> ) . . . . .	12,000
White Campion ( <i>Lychnis vespertina</i> ) . . . . .	3,500
Mouse-ear Chickweed ( <i>Cerastium vulgatum</i> ) . . . . .	36,000
Dove's-foot Geranium ( <i>Geranium molle</i> ) . . . . .	4,500
Cut-leaved Geranium ( <i>G. dissectum</i> ) . . . . .	1,900
Wild Carrot ( <i>Daucus carota</i> ) . . . . .	4,400
Field Madder ( <i>Sherardia arvensis</i> ) . . . . .	2,500
Ox-eye Daisy ( <i>Chrysanthemum leucanthemum</i> ) . . . . .	11,000
Stinking Mayweed ( <i>Anthemis cotula</i> ) . . . . .	12,800
Scentless Mayweed ( <i>Matricaria inodorata</i> ) . . . . .	11,800
Wild Chamomile ( <i>M. chamomilla</i> ) . . . . .	79,000
Groundsel ( <i>Senecio vulgaris</i> ) . . . . .	21,800
European Clover Dodder ( <i>Cuscuta trifolii</i> ) . . . . .	18,000
Chilian Dodder ( <i>C. racemosa</i> ) . . . . .	7,300
Self-heal ( <i>Prunella vulgaris</i> ) . . . . .	6,800
Rib-grass ( <i>Plantago lanceolata</i> ) . . . . .	3,000
Hoary Plaintain ( <i>P. media</i> ) . . . . .	8,500
Goosefoot or Fat-hen ( <i>Chenopodium album</i> ) . . . . .	6,600
Curled Dock ( <i>Rumex crispus</i> ) . . . . .	3,200
Sheep's Sorrel ( <i>R. acetosella</i> ) . . . . .	10,500
Yorkshire Fog ( <i>Holcus lanatus</i> ) in glumes . . . . .	8,900
Yorkshire Fog ( <i>H. lanatus</i> ) without glumes . . . . .	12,700
Wavy Hairgrass ( <i>Aira flexuosa</i> ) . . . . .	8,400
Tufted Hairgrass ( <i>A. cœspitosa</i> ) . . . . .	25,500

In order to estimate the real or cultural value of any sample, only the pure seed, after the removal of the impurities, is tested for germination capacity, as it is essential to know the percentage of pure seeds present as well as their germination capacity, and further

it is not merely the proportion of seeds that germinate which is important, but also the speed with which they arrive at the seedling stage. All who have sown seeds in boxes, or observed seedlings in the field, know only too well that those which germinate first develop into the strongest plants, while those which struggle through the soil at a later date remain weakly and often die. It is generally agreed that the real or cultural value of a sample of seed is obtained by multiplying the percentage purity by the percentage germination capacity, and dividing by 100; for example, the real value of a sample of clover seed of 96 per cent purity and 80 per cent germination capacity is:—

$$\frac{96 \times 80}{100} = 76.8 \text{ per cent.}$$

Farmer's can often conduct simple tests on germination capacity by sowing a given number of seeds, 100 for preference, in an ordinary flower-pot and covering them lightly with a thin layer of soil. The pots should be placed in a dark room or shed away from strong light, except in the case of seeds of the meadow grasses, which germinate best in the light. As moisture is one of the essentials of successful germination it is as well to place the pots in saucers filled with water. This practice answers very well for all the larger seeds, but smaller seeds, like those of clovers and grasses, are best germinated between pads of blotting-paper placed between two dishes. Once moistened the blotting-paper will usually contain sufficient water to encourage germination, and by slightly tilting the top plate, the admission of air can be easily regulated. Seeds of celery, the meadow grasses, Timothy, and other very small grass seeds need no top layer of blotting-paper.

The number of days the test should be continued before a final result is obtained is given in the following table:—

	Days.
Beans, Peas, Vetches, Clovers, Kidney Vetch, Lucerne, and Trefoil . . . . .	10
Cereals, Flax, Chicory, Rape, Mustard, Turnips, Cabbage, Buckwheat, Radish, Sunflower, Spinach, Lettuce, and Maize . . . . .	10
Sainfoin, Serradella, Rye Grasses, Tall Oat Grass, Celery, Carrot, Parsnip, Hemp, Onion, and Cucumber . . . . .	15
Cock's-foot, Fescues, Crested Dog's-tail, Brome Grasses, and other grasses except Meadow Grasses ( <i>Poa</i> ) . . . . .	20
Meadow Grasses ( <i>Poa</i> ) and Parsley . . . . .	30

The seeds should be examined daily, and all those which have germinated should be removed, a daily record being kept of the number. Only those seeds which show a radicle should be counted.

Sampling.—When seeds are taken from sacks or bins for testing every effort should be made to see that the sample is representative of the bulk. When quantities of not more than a sack or a quarter are to be tested, the seed may be poured out on a clean floor and thoroughly mixed, after which small quantities may be taken from various parts of the heap to make up the required amount for testing.

Where larger quantities than a quarter have to be tested, representative sacks should be picked out for mixing. When the seed is in bins a grain sampler should be used, consisting of a cylindrical tube, fitted with a number of separate compartments, capable of being opened and closed at regular depths, and thus seed is taken from the top, middle, and bottom of the bin.

**Apparatus.**—For analytical seed-testing the following apparatus will be required :—

1. A chemical balance, provided with accurate metric weights.
2. A seed mixer and sampler.
3. A nest of small copper sieves.
4. A stand-mounted reading glass, also a hand lens magnifying from 10 to 16 diameters.
5. Botanical forceps and dissecting instruments.



FIG. 65.—Portion of Seed-testing Laboratory, showing seed germinators.

6. A standard germinating chamber with low temperature thermometers.
7. Blue blotting-paper, and flannel.
8. Sterilized sifted sand, and shallow greenhouse flats.

The purity testing of samples can be greatly facilitated by sifting the sample, and the sieves used for this purpose should be five in number of various meshes, and each so fitted to each other that when using them the coarsest one may be placed on the top, and the finest one at the bottom. Sieves are best made of brass wire forming a square mesh. The sizes found most convenient are 18, 20, 22, 26, and 30 meshes to the square inch. In sifting, the seed should be placed in the top sieve and the whole gently shaken.

There are many different types of seed germinators, such as those shown in Fig. 65, used by Messrs. James Carter, Ltd., and other



seed merchants and agricultural institutions. That known as the "Simplicitas" is largely used by corn merchants and is provided with thick porous dishes or bricks (Fig. 66) on which the seeds rest, but in many cases we have noticed that the seeds are kept over-saturated, and not infrequently they become steamed through overheating. Porous earthenware is most suitable as a receptacle for the meadow grasses and other seeds which take a long time to germinate, while sand, which must be first rendered free from



FIG. 66.—Germination of Seeds on porous dish.

organisms by sterilizing, is especially suitable for mangels. Folded flannel should only be used for the larger seeds, and must be sterilized by boiling, after each test. In using blotting-paper, care must be taken to see that it is kept moist, but not saturated with water during the test, and the same paper should not be used twice. It will be more convenient for counting if the paper is marked out into one hundred squares.

#### SPRAYING.

The operation of spraying cannot be disregarded by anyone who is engaged in the cultivation of plants either in the open-air or under glass. The writer has occasion to remember some of his first spraying experiments, when few farmers or fruit-growers had as yet seen a spraying machine, much less observed the beneficial effects of the process upon hops, potatoes, and fruit-trees, while the very idea of spraying charlock as a means of eradicating that persistent pest was looked upon as little short of an absurdity. For arresting insect or fungoid diseases, whatever the remedy used, the earlier it can be applied to the affected plants the more certain will be the result.

Jets, formerly used for washing plants, have been found to distribute fluids too irregularly. Syringes provided with perforated caps allowed of finer distribution, but it was not until the introduction of the spraying machine, fitted with jets, that what are now known as spray-fluids were capable of economical and effective application. Inventors have now perfected all kinds of spraying machines, from manual, to oil and petrol driven machines, which allow the spray to be distributed at pressures of from 100 to 120 lb. per square inch when being used as insecticides for orchard trees. A good spraying, however, is also obtainable by means of a small hand syringe. A high-pressure pneumatic sprayer is shown in Fig. 67.

If spraying is performed in good time, one application may be sufficient, and not only is it more economical to spray early, but, if delayed, two or more applications may be necessary. The development of fungoid spores and insect eggs, like those of higher orders of plants and animals, takes place in early spring, and therefore a sharp look-out should then be kept on all plants and trees likely to become infected.

The effectiveness of a spray in arresting the devastations of fungoid pests and leaf-eating insects depends on the fine and even distribution of the fluid, which should resemble that of dew, on both the upper and lower surfaces of the leaves, or in the case of dry sprays on the even distribution of the powder (Fig. 68). Some insects are destroyed immediately the fluid comes in contact with them, in which case a coarse spray, forcibly applied, is usually preferable. Other insects puncture and suck the juices of the leaves, causing a distortion of the foliage, so that it curls up at the edges, thus providing themselves with a means of protection, while some spin webs, under cover of which they continue their work of destruction. Others again smear their bodies with excrementitious matter, which enables them to withstand one or more sprayings, in the same way that slugs are

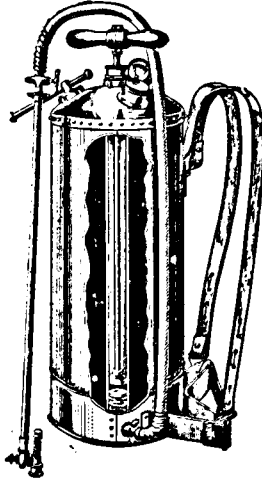

FIG. 67.—Hartjen's high-pressure Pneumatic Sprayer.

protected from the effects of lime dressings by their slimy secretions, but these defences cannot be produced in sufficient quantity to withstand repeated dressings.

Whatever the plant sprayed, care should be taken to see that the work is done thoroughly. In the case of a tree, the fluid should be applied close to the bottom of the trunk, the operator working upwards until every twig and leaf is moistened.

With regard to potatoes, it is usually the main crop that is affected, as the early varieties have generally been dug before the weather conditions become most favourable for the propagation and development of the blight. Whenever the conditions are such as lead the grower to anticipate disease, spraying should be commenced, before there is any actual indication of its presence, as it must be clearly

understood that the object of spraying is to prevent rather than to cure the disease.

The action of particular spraying fluids destroys certain plants, as for example Bordeaux mixture, which will soon cause the leaves of charlock to shrivel up and die, or if death does not actually take place, the flowers are produced prematurely, and have no power to develop ripened seed. The cereal plants and young clovers, among which the charlock is growing, remain uninjured, the only noticeable effect being that growth may be arrested for several days, the leaves assuming a somewhat rusty or brown appearance, but, after this, growth continues with renewed vigour. Here again spraying must be performed at the proper time, and whenever possible on a dull and calm day. In the case of charlock (Fig. 69) there is no better time than when the principal leaves of the plant are fully developed, and when the corn has attained a height of at least 6 inches.

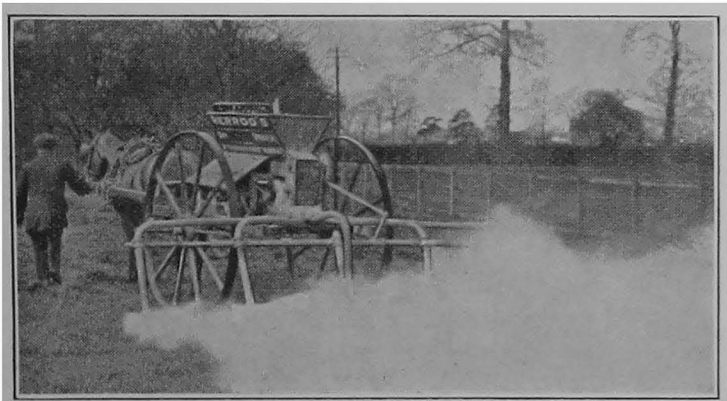

FIG. 68.—Dry spraying Potatoes.

If properly applied, one spraying is sufficient to destroy charlock, but with potatoes (to prevent disease) several applications may be necessary, as it must be borne in mind that the plants are in a state of active growth, thereby necessitating a second spraying a fortnight or so after the first. The sprayers are so constructed as to admit of the under surfaces of the leaves being sprayed as effectively as the upper surfaces.

Spraying machines will last for a considerable time if properly cared for, and under no circumstances should they be put away until they have been thoroughly cleansed by forcing clean water through the tubes and nozzles, first removing any sediment remaining in the reservoir. Considerable trouble and delay is often occasioned by the careless straining of spray fluids into the machine before use, the smallest particles of foreign matter being sufficient to block the minute perforations of the nozzles.

Insect pests, destructive to plant life, may for our present purpose be classified first, as those which abstract the juices of the plant by

understood that the object of spraying is to prevent rather than to cure the disease.

The action of particular spraying fluids destroys certain plants, as for example Bordeaux mixture, which will soon cause the leaves of charlock to shrivel up and die, or if death does not actually take place, the flowers are produced prematurely, and have no power to develop ripened seed. The cereal plants and young clovers, among which the charlock is growing, remain uninjured, the only noticeable effect being that growth may be arrested for several days, the leaves assuming a somewhat rusty or brown appearance, but, after this, growth continues with renewed vigour. Here again spraying must be performed at the proper time, and whenever possible on a dull and calm day. In the case of charlock (Fig. 69) there is no better time than when the principal leaves of the plant are fully developed, and when the corn has attained a height of at least 6 inches.

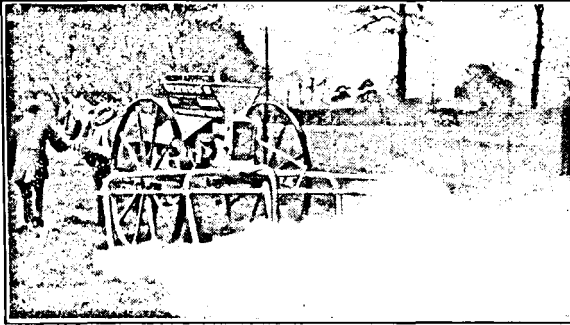

FIG. 68.—Dry spraying Potatoes.

If properly applied, one spraying is sufficient to destroy charlock, but with potatoes (to prevent disease) several applications may be necessary, as it must be borne in mind that the plants are in a state of active growth, thereby necessitating a second spraying a fortnight or so after the first. The sprayers are so constructed as to admit of the under surfaces of the leaves being sprayed as effectively as the upper surfaces.

Spraying machines will last for a considerable time if properly cared for, and under no circumstances should they be put away until they have been thoroughly cleansed by forcing clean water through the tubes and nozzles, first removing any sediment remaining in the reservoir. Considerable trouble and delay is often occasioned by the careless straining of spray fluids into the machine before use, the smallest particles of foreign matter being sufficient to block the minute perforations of the nozzles.

Insect pests, destructive to plant life, may for our present purpose be classified first, as those which abstract the juices of the plant by

sucking ; and second, those which consume the leaves and delicate growths of the plant by eating or gnawing them. As to fungoid diseases, some attack the surfaces of the plant, such as mildew, and others are of internal growth and destroy the tissues and organs.

Aphis or American blight, scale insects, red spider, black currant gall mite, and apple sucker are examples of sucking insects, while as typical of those which bite and consume the foliage may be mentioned the winter and the codlin moth.

**Spray-Fluids.**—There are now very many forms of spraying fluids on the market, for all of which special merits are claimed. Sulphate of copper, burnt lime, liver of sulphur, and caustic soda largely enter into the composition of fungicides ; while paraffin, soft soap, quassia, carbolic acid, arsenic, and nicotine form the basis of many of the more popular insecticides. The student must, however, learn to make



FIG. 69.—Wet spraying Charlock.

up these standard recipes for himself, and for his guidance we may mention the following formulæ :—

*Bordeaux Mixture*

	For Potatoes.	For Fruit-trees.
Copper sulphate (98 per cent) . . . . .	6 lb.	4 lb.
Lime (in lumps and freshly burnt) . . . . .	4 lb.	4 lb.
Water . . . . .	50 gals.	50 gals.

First slake the lime until it is in that condition known as milk of lime ; dissolve the copper sulphate separately in 4 gallons of water, using a wooden tub, and then pour the lime into the copper solution.

*Burgundy Mixture*

Copper sulphate (98 per cent) . . . . .	2 lb.
Washing soda (pure) . . . . .	2½ lb.
Water . . . . .	10 gals.

Dissolve the sulphate in 9 gallons and the soda in 1 gallon of water, then stir the soda solution thoroughly into the copper solution.

Both the above fungicides may be used to ward off potato disease (*Phytophthora infestans*) (see Fig. 292), and are useful for application to plants attacked by fungoid diseases.

*Woburn Winter Wash*

Copper sulphate . . . . .	1½ lb.
Lime . . . . .	½ lb.
Paraffin (Solar distillate) . . . . .	5 pints.
Caustic soda . . . . .	2 lb.
Water to make up . . . . .	10 gals.

Dissolve the copper sulphate in 8 or 9 gallons of water, slake the lime in water, and add it to the copper solution, straining it through a fine sieve. Then churn in the paraffin, and add the caustic soda. Finally, add water to make up to 10 gallons.

This wash cleanses the bark of trees, removing moss, lichen, etc., and it is also fungicidal. It should be applied early in February, and is suitable for the destruction of oyster-shell bark lice, mussel scale ova, etc.

*Copper Sulphate*

For spraying charlock, copper sulphate is used alone. A 3 or 4 per cent solution should be made of copper sulphate of 98 per cent purity, and applied at the rate of 48 gallons per acre when the charlock is in rough leaf.

*Paraffin Emulsion*

Paraffin . . . . .	2 gals.
Soft soap (8 per cent potash) . . . . .	½ lb.
Boiling water . . . . .	1 gal.

Boil together the soft soap and water, and, while boiling, pour in the paraffin. Churn thoroughly by means of a spray syringe until a milk-like mass or emulsion is the result. For use dilute with 10 gallons of water.

This is one of the most effective and useful of all insecticides, especially for the destruction of sucking insects.

*Paraffin Metal Emulsion*

Iron sulphate . . . . .	10 oz.
Lime . . . . .	5 oz.
Solar distillate . . . . .	24 oz.
Water . . . . .	10 gals.

Dissolve the sulphate in water and add the lime, then churn in the paraffin and make up to 10 gallons with water. Aphides, leaf-hoppers, thrips, and some caterpillars are destroyed by this wash, which is used in summer. It makes a more perfect emulsion than when soft soap is used.

*Soap and Carbolic Acid*

Soft soap	20 oz.
Carbolic acid (Calvert's No. 5)	1 oz.
Water	10 gals.

The soap should be melted, not dissolved, and, when oily, the carbolic acid should be poured in, stirring until the whole possesses a uniform dark-brown colour; then add  $\frac{1}{2}$  gallon of boiling water and make up to 10 gallons, when the wash will be ready for use. It is also used against sucking insects.

*Arsenate of Lead*

Arsenate of soda (pure or crystalline)	3½ oz.
Acetate of lead (98 per cent)	7 oz.
Water to make	10 gals.

Dissolve the two chemicals in separate vessels, and, when completely dissolved, mix and add the remainder of the water, and stir briskly. This is chiefly used for biting insects, and adheres well to the foliage to which it is applied.

## WEEDS.

The species and varieties of weeds found on arable land and pastures are considerably less numerous than they were some fifty or more years ago, due to the fact that in most districts roads have been widened, ditches scoured, hedges kept cleanly trimmed, and the roadside grazing of cattle prohibited. The wide stretches of roadside herbage, although picturesque, and still common in Southern England, proved a breeding ground for a very large number of British weeds, the majority of which were distributed over the adjoining fields through cattle partaking of the ripe herbage in autumn, and leaving their excrements on the land; also by birds, water, wind, and other agencies.

However carefully fields are tilled and weeded in summer and autumn, the advent of spring will be accompanied by a full complement of weeds. A good farmer gives these as little chance to germinate and prolong life as possible; the seedlings he destroys as soon as possible by harrowing or hoeing, while the more stubborn plants of perennial habit can to a great extent be eradicated by continually depriving them of their foliage.

A root or fallow-crop affords the best opportunity for cleaning arable land, but it is sometimes necessary to use a bare or summer fallow on heavy retentive soils infested with troublesome, strong-rooted weeds.

Pasture Land Weeds.—Farmers are often heard to say that young cattle will not thrive in this or that meadow, and if the reason be sought for, it will invariably be found that the meadow in question contains many grasses of an innutritious and indigestible character, such as Bent (*Agrostis vulgaris*), Yorkshire Fog (*Holcus lanatus*), Quaking Grass (*Briza media*), Soft Brome Grass (*Bromus mollis*), and even the still more indigestible Cotton Grass (*Erisphorium vaginatum*), Common Carex (*Carex vulgaris*), Sedge (*Carex paludosa*),

and many others, equally injurious and irritating to the digestive organs of young stock.

Water-meadows, the "carriages" of which have been neglected, abound in numerous varieties of aquatic and semi-aquatic weeds, including many of the above-mentioned grasses. Prominent among water-meadow plants and those growing in most badly drained pastures may be mentioned Water Plantain (*Alisma plantago*), Lesser spearwort (*Ranunculus flammula*), and Marsh Marigold (*Caltha palustris*), the latter being very conspicuous throughout the early part of the year, as, in fact, are also many other species and varieties of weeds which inhabit damp pastures. Such are Lady's Smock (*Cardamine pratensis*), Lousewort (*Pedicularis palustris*), Ragged Robin (*Lychnis flos cuculi*), Common Mallow (*Malva sylvestris*), Crane's Bill (*Geranium pratense*), Queen of the Meadows (*Spiraea Ulmaria*), Silver-weed (*Potentilla anserina*), Willow Herb (*Epilobium parviflorum*), Marsh Thistle (*Cnicus palustris*), Dandelion (*Taraxacum officinale*), Cowslip (*Primula veris*), Common Rush (*Juncus communis*), and many others of minor importance. Rushes and water plantain acquire strength in proportion to the amount of water present in the soil, as will be readily noticed wherever water furrows or ditches are waterlogged.

When pastures are neglected, or temporary leys are badly laid down, they are liable to become infested with numerous weeds such as Buttercup (*Ranunculus bulbosus*), Daisy (*Bellis perennis*), Goats-beard (*Tragopogon pratensis*), Hawkweed (*Hieracium pilosella*), Knapweed (*Centaurea nigra*), Hoary Plaintain (*Plantago media*), Ribwort (*Plantago lanceolata*), Spear Thistle (*Cnicus lanceolatus*), Welled Thistle (*Carduus crispus*), while on down land the Dwarf Thistle (*Cnicus acaulis*) is commonly to be seen.

**Arable Land Weeds.**—Arable land weeds are innumerable, and it would be quite possible to collect several hundred varieties on any large farm comprising soils of a varied character. Few of these, however, cause the farmer any real trouble and expense except such deep-rooted weeds as Couch (*Triticum repens*), Dock (*Rumex obtusifolius*), Thistle (*Cnicus arvensis*), Lily-root (*Convolvulus*), Crowfoot (*Ranunculus arvensis*), Coltsfoot (*Tussilago farfara*), Small Bindweed (*Convolvulus arvensis*), and a few others less frequently met with.

When the weather permits of stubbles being skimmed and cleaned in the autumn, and the surface being well harrowed, the majority of the annual weeds are gathered into small heaps and burned, and the ashes are spread over the ground. Couch, convolvulus, and thistles which have underground stems soon reproduce themselves in spring in proportion to the number and vigour of the buds which remain near the surface of the ground. Continual removal of the foliage will, however, promote the permanent decay of these subterranean stems. When the corn crop is followed by a root crop, as is usually the case, except when a second straw crop follows wheat, a free use of the hoe will generally complete the work of eradication, at least for that season.

The Weeding of Cereal Crops comprises one of the most important of spring operations on the farm, and especially where wheat follows



clover lea, or where old grass leas are ploughed up in preparation for oats. The usual custom in these cases is to plough and press the ground, thereby obtaining an ideal seed-bed for broadcasting; but where the ground is infested with seedling docks and a host of other troublesome weeds, it is preferable to plough somewhat shallower, and to cultivate and drag the ground in readiness for drilling, and this will enable the greater part of the weeds to be removed. If docks are ploughed under to a depth of 6 or 8 inches, much difficulty and expense is entailed in extricating them in spring, while, if kept near the surface, they can often be pulled up by hand, and thus avoid undue disturbance of the wheat plants, which is inevitable when a dock-digger is used.



FIG. 70.—Clover Dodder (*Cuscuta trifolii*). A, clover plant attacked by dodder; B, germinating seeds of clover and dodder; C, section of clover stem encircled by dodder sucker; D, dodder seed; E, white clover seed; F, red clover seed.

Thistle "spudding", or cutting, is best done when the young corn is about 8 inches high, by which time the underground stems of the thistles will have developed a quantity of leafy growth above ground. The rapid growth of the corn at this stage prevents the thistles from regaining their strength, and any new growths become drawn up in their effort to secure sunlight, and flower and seed prematurely, but few seeds so produced ever germinate.

Old worn-out sainfoin leas are often infested with a variety of weeds of perennial growth, and are responsible for the continuous germination of weeds for many years in succession.

Charlock or Wild Mustard (*Sinapis arvensis*) is one of the worst weeds that the farmer has to encounter in spring-sown corn, but, owing to much careful investigation on the part of Messrs. Strawson and other experimenters, it is now possible at a minimum cost to completely destroy the plants at an early state in their growth by spraying, as already described.

**Parasitic Weeds** are fortunately not very numerous. Dodder (*Cuscuta*) (Fig. 70) is undoubtedly the most to be dreaded, and does the most damage to crops of red clover. The weed is a flowering plant, the thin thread-like stem of which winds itself spirally round that of the clover plant, on the sap of which it feeds by means of suckers. It is frequently seen attacking heather, furze, and many species of wild plants. At first the dodder is rooted in the soil, but it gradually extends its parasitic stems to neighbouring clover plants, when it leaves its hold of the soil and lives wholly upon the clover. The dodder is exceedingly prolific, each of its flower balls being capable of yielding sixty seeds, after which the weed dies. Prevention is always better than cure, and a written guarantee should always be insisted upon that all clover seeds purchased are free from this insidious weed. Infected patches of clover should be dug out and all the plants carefully burnt.

The Yellow Rattle (*Rhinanthus crista galli*) is of semi-parasitic character and of annual growth. On some pastures it becomes so abundant as to considerably arrest the growth of the desirable grasses, and greatly impair their value as food. Moreover, if its seeds are numerous in hay, live stock may be poisoned with fatal results. Its conspicuous yellow flowers are easily recognized, and it is chiefly found in poor, damp, or wet meadows, and less frequently on down land. This pest is rarely prevalent on perfectly drained land where a finer and better herbage has been encouraged by judicious manuring.

Broom Rape (*Orobanche*), of which there are two well-known species, major and minor, is very commonly met with in clover fields, where it is truly parasitic on the roots of the clover. Similar remedies are adopted as in the case of dodder.

In order to become intimate with weeds the student should provide himself with a vasculum and digging fork, and make a collection of those most prevalent in his district, when, with the aid of a good textbook, he will be able to classify them, and so provide himself with a vast amount of first-hand knowledge, which is always the most useful.

## PART II.

*LIVE STOCK, FEEDING, AND ECONOMIC  
ZOOLOGY.*

## PART II.

### *LIVE STOCK, FEEDING, AND ECONOMIC ZOOLOGY.*

---

#### CHAPTER I.

##### LIVE STOCK.

THE importance of live stock on a farm is based upon both direct and indirect profits. So far as the first are concerned, they may be apparently very large in the case of individual pedigree animals, but, on the other hand, such results cannot be achieved without a great expenditure of capital and skill, as well as after many disappointments and risks. Success in breeding also needs time for establishing a reputation, so that many of the most celebrated flocks and herds are in the hands of the descendants of those who originally started them.

The reward is well earned, because the reputation of a stud cannot be maintained without continuous effort, and is easily lost, so that it is as difficult to keep as to win a premier position.

The breeding of pedigree stock is highly technical, and bids fair to become much more scientific in the future than in the past. It is beyond the scope of this work and touches all classes of animals from race-horses to poultry, or from dogs to canary-birds. It has enlisted the attention of the most celebrated naturalists and physiologists, for it includes considerations affecting the well-being of the human race. Ordinary stock-owners, however, derive very great benefits from the efforts of high-class breeders, but few of them enter upon the difficult task of systematic improvement, which indeed requires special talents for its successful prosecution.

Still, to a certain degree, breeding is carried on upon most farms; and the ordinary management of live stock naturally resolves itself into three definite sections, namely breeding, rearing, and fattening. When each of these branches is applied to cattle, sheep, pigs, and poultry—not to say horses, destined for a great variety of uses—it will be seen that, even omitting pedigree breeding, the management of live stock is a great subject.

The plan pursued in the following pages will be to take each class of stock and treat of it upon the above lines; and horses naturally are given the first place, although of less importance from a farming

point of view than cattle and sheep. As to "breeds", they are so numerous and deserve so much study and attention that it is impossible to do justice to them all.

They are adapted for particular situations, and sometimes suffer from being transferred to unfavourable localities. They differ in important respects from each other, but, at the same time, possess many points in common. A horse is after all a horse, irrespective of his size, colour, or degree of speed; cattle closely resemble each other in voice, instincts, habits, and products, as do also sheep and pigs, so that a man who can manage one breed can accommodate himself to another. This makes our task somewhat lighter, for it is possible to treat of management (the widest term available) without entering too minutely upon the peculiarities of different races of the same species.

Within these prescribed limitations we can enter upon our task, feeling that there are abundant sources of information available upon breeds, every one of which boasts a society for its promulgation. It is, indeed, unnecessary to describe every breed separately or to give a large number of pictorial illustrations, when they are to be seen in advertisements and descriptions of notable animals in Live Stock Journals, or can be seen in actual existence at agricultural shows. What is therefore proposed at present is to give a concise account of the main points of successful management, beginning with horses.

#### HORSES.

Not only are agricultural horses of paramount importance to farmers for draught purposes, but they command the largest amount of popular attention in show-yards. They are also capable of realizing prices for breeding which rival those of races used for higher purposes. The breeding of heavy draught horses has been a profitable industry in the past, and, indeed, up to the present time. The industry is, however, threatened by motor power, especially on the roads and in towns, but hitherto the horse has maintained his position on the land.

The breeding of colts to renew the farm team has always been a worthy object with farmers, and entails brood mares, foals, yearlings, 2 year olds, and 3 year olds. The life of a farm-horse may be taken as extending over from 16 to 20 years, and the entire team will require to be renewed in from 12 to 16 years, supposing the colts to come into full work at 4 years old. There are also casualties to be taken into account, so that in a team of twelve horses one at least may need to be replaced every year. Hence one foal a year seems necessary, but as mares sometimes disappoint hopes, and foals may die, two a year are not too many to aim at. Foals do better in company, and so much is this felt to be the case that farmers often buy a weanling at Michaelmas as a mate for a solitary foal. In order to secure one or two foals it is advisable to present three mares for service in spring, as one at least may fail to produce a live foal.

Brood mares may produce their first foal when they are 4 years old, although some breeders consider that they may do so a year

younger. It is a mistake to breed from faulty mares, or to devote a mare to breeding when she is past her prime. Good mothers are as important as good sires, and the mare should be worthy of the services of a good horse. Congenital defects, such as side-bones, spavins, grease, etc., should disqualify either a horse or mare for breeding.

**Mares during Pregnancy.**—The period of gestation in mares is forty-eight weeks, and they are capable of conceiving again nine days after parturition. This fact is commonly acted upon, and it is a more likely period for securing conception than if mating were postponed to a later date. Mares come in season regularly every three weeks until conception takes place, and cessation of the symptoms of œstrum is a reliable sign that they are in foal. It is desirable that foals should be born early in the year, and the tendency is for mares to produce sooner every season, i.e. if they are successfully served nine or ten days after delivery.

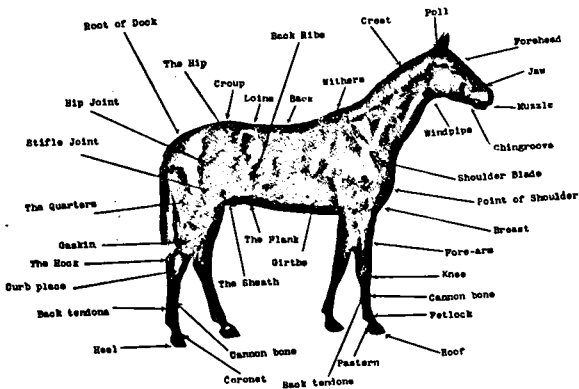

FIG. 71.—Diagram showing points of the Horse.

In entering for show, horses are stated to be born within the year commencing January 1, but if earlier they belong to the previous year, which is an evident disadvantage in competition. In ordinary practice mares foal in March, April, and May, and stallions are shown on the markets and begin to travel in March. They visit the farms where they are engaged for service every three weeks, or arrangements are made for meeting mares at certain depots.

The Management of Brood Mares does not naturally differ from that of other horses for at least the first five months, although they should be guarded against all shocks or strains. They probably are nursing during the summer, and, if so, are usually worked upon the land, accompanied by their foals. The alternative is to shut up the foals, but freedom is essential for young animals, and it is an advantage that they should be able to suck frequently. Mares which

## 192 LIVE STOCK, FEEDING, AND ECONOMIC ZOOLOGY.

come in overheated, and with "stocked" udders, are liable to yield heated milk, which disagrees with foals, and may even cause death. Foals which follow their mothers receive a good deal of attention from the men and boys, and are frequently handled and petted. This is a sort of preliminary training; and one of the advantages of horses being bred on the farm is that they know their way about, and are acclimatized to the situation.

Mares are better worked on the land, in backband and chains, than on roads in cart harness between shafts. They should never be made to "back" carts or wagons, to haul timber or heavy loads, such as engines or threshing machines, but to plough, harrow, and do other tillage work. The mares should stand free at the dinner hour, and not be tied up, as foals may become entangled in a halter rope and get injured. Mares may be worked up to foaling-time, and are better for the exercise. They have often been known to foal straight out of work, but a little judgment should be exercised, and if parturition seems imminent they should sleep in a roomy horse-box. They are very timid or shy, and prefer to foal alone, so that not many people have been present at the birth of a foal. As a rule parturition is quickly over, but in some cases professional aid must be called in.

Mares on the point of foaling should be closely looked after until the foal is born, and is on his feet and has sucked. The mare should then have a warm bran mash, and be allowed green food or roots, and should be kept in for a day or two before being turned out into a pasture. This should be near home, and free from barbed wire, ponds, quarries, or any ditch or stream into which the foal might wander. After a few days, say a fortnight, or in some cases a month's rest, the mare may resume her usual duties. It is objected against breeding horses, by some farmers, that brood mares are idle during a busy time of year, but this is overruled where there are young horses coming in, as they can be worked during the time mares are laid off, and can have a summer's run later.

Foals first obtain their food entirely from their dams, but soon learn to eat grass, and they may take a little growing corn and make excursions into mowing grass or standing crops and do a little harm; but this is trivial in comparison with the advantages of freedom and a choice of victuals. They are usually weaned at Michaelmas by shutting them in together (no young animal likes to be alone) in a house where there is nothing to entangle or injure them, and are fed with green food and a few bruised oats. They soon become reconciled to the loss of their dams, and are then turned out into a rough pasture provided with a hovel, rack, and manger, and there they will remain and grow a warm coat. Foals require to be well kept during their first winter. The racks and mangers should be kept replenished, but not left full of stale food; and as long as they are seen to be well cleaned out the foals are not being overfed.

About half a bushel of oats a week, and a supply of sweet hay, free from mould, will be enough, with what they can pick up from the ground. If neglected, foals may become thin and weak, especially towards spring, but they should always be well looked after and never allowed to go back in condition.

The second summer, when they are yearlings, they are run upon good grass land, and here it may be observed that limestone soils are the best for horse-breeding. Ireland is famous for its horses, and consists largely of mountain limestone soils. Soft or boggy land, with its abundant herbage, is also excellent for young horses, and where keep is abundant no corn is needed.

The second winter need not differ as to treatment excepting that the allowance of corn is doubled, but it is a mistake to adhere too slavishly to prescribed quantities. A mixture of oats and beans, with an allowance of good hay, given at short intervals, with the observance of the rule as to cleaning up what is given, and of increasing the quantity of food gradually, is all that is needed, and this brings the colt to his third summer, as a 2 year old.

At this age the question of *breaking* comes in. It is the custom of many good farmers to yoke young horses to light implements at 2 years old, but it is wiser to put off breaking at least until they are 2½ years old. When horses are worked too young they are liable to become strained, and one of the most common results is that they rise at the loins, or become "up in the back". This happens very quickly, and may be due to one too vigorous pull. They also may contract spavins, side-bones, splints, ring-bone, or stiff shoulders, as well as blemishes, and their useful life will be shortened. There can be no doubt that if work is put off until colts are 4 years old they will last much longer, and some good instances might be quoted in which horses that have been allowed to run wild even to a greater age, have lasted until they were well over 30 years old. The writer has known colts left unbroken till they were 6 years old, but this was a "fad" on the part of the owner, or rather owners.

If young horses are gradually "worn in" to light work at 2½ years old, they at least have the advantage of a warm stable, of regular grooming, and of a full allowance of corn; and when this plan is followed they should be lightly worked, as will be presently explained, and turned out for a summer's run. They will then come in as members of the regular team at 3½ years old. This is not hurrying matters too much, but some successful rearers of young horses prefer postponing all these stages just one year more, and to bring the horse into regular work at 4½ or rising 5 years old.

Young draught horses are not lunged and paced like roadsters or hunters, but are bitted and broken in a simpler manner. They should be handled from their birth and taught to be led by a halter, to lift their feet for shoeing, and to be handy and gentle. They may then be bitted by means of a breaking bridle, which they will champ until their mouths become tender, i.e. amenable to the rein. In yoking a young horse he should first be accustomed to carry harness and not to be afraid of the rattle of chains, or the tightening of the girth. His first lesson in actual drawing must be very gently imparted, and on no account must he be allowed to run away. Long cords should be attached to the bit on each side, and be held by trustworthy men while he is led out by the bridle. He must be accustomed to this exercise, and will then be ready to be yoked between two steady horses in a plough, or even to a heavy log.



He is naturally frightened, and breaks out into a profuse sweat, and ought not to be too severely tried at first. The harrow is not suitable, as it may turn over and injure a youngster ; but in a plough, between two old stagers, he may help to turn a shallow furrow. Half an hour is quite long enough for a start, and he should then be taken back to the stable. For some time after this introduction to labour, quarter days and half days are enough for his strength, and during the whole of his first winter he cannot be looked upon as more than half a horse. A summer's run is then just what is required to complete his education, and he will come up in time for wheat sowing, rising 4, or rising 5, according to the system which has been adopted.

**The Management of a Farm Team.**—Feeding is, of course, a very principal point, and seems to demand first attention. The accommodation, the hours of work, and the treatment at different times of year are, however, of great importance, and the reader is now asked to study a few remarks which are meant to be very practical. It may be taken for granted that every good teamsman and farmer knows all we have to say, but they do not always practise what they know, and it is desirable that every agricultural student should have clear views as to what constitutes good management of a team. Stables are better open to the roof than provided with lofts, and should face the east (see also Farm Buildings). Some stables have acquired a bad reputation for illness, probably due to their situation and surroundings, and it is desirable that they should be light, airy, and well drained.

Regularity in feeding, watering, and grooming are all of the highest importance, and much might be written upon each point. Horses are slow feeders, and unless their corn is supplied in good time, it may be left in the mangers ; or they may learn to bolt their food. Earliness and punctuality are important qualities in a head teamsman, and if they are lacking his animals soon show it by their poor condition.

Cold water may cause colic if taken when the body is overheated. It is, however, still more dangerous for horses in a cold and exhausted state, and is least likely to be harmful if given immediately after work or exercise. Horses should be watered during the day, and not allowed to come in thirsty to the stable. If their work is far removed from a pond, sliced roots should be mixed with their corn and chaff in the nosebags, and, if this is attended to, many cases of colic will be avoided. In some stables water is laid on to self-filling troughs, so that the horses always have it before them ; and, considering the occasional kicking accidents which happen around the horse-trough, the plan is to be highly recommended.

Regular grooming, night and morning, is also important. It may be done by straw wisps vigorously used, and by brushes, and curry and mane combs. The feet and legs should be washed and rubbed dry, and a good bed provided before the stable is left.

**Foddering Time.**—Eight o'clock at night is the usual time for revisiting the horses, and dressing, suppering, and bedding them up. The lanterns are lighted, and the feeder proceeds to prepare and place the corn in each manger, and to replenish the racks with fodder.

In the North of England each pair is committed to the care of one good man, and eight o'clock is his time for dressing them. In the southern counties, where the stable is in charge of one head teamsman, or "carter", he alone may appear on the scene. In either case the animals are well looked after, and many farmers make it a point to be present, not only to see that the work is properly done, but to have a word with the head carter about the disposal of the teams next morning.

**Food and Feeding.**—The food given varies with the season of the year and the character of the work, and naturally corresponds with the seasons. Thus feeding may be divided into four periods; but, as horse-feeding changes in character with the advent of green or summer fodder, and again with its cessation, the chief alterations take place in May and October. During the summer horses require but little corn, and green food takes the place of hay. They are in many cases turned out at night, much to the relief of the "carters", and apparently to their own satisfaction. Summer feeding is therefore simpler than winter feeding, but whether it is less expensive depends upon the prices put upon night grazing, cut clover, vetches, lucerne, and other descriptions of green food. In most published comparisons of costs the two seasons work out much alike in this respect, but estimates based upon 10s. a ton for green fodder are above prime cost, which is the only basis upon which home-grown produce should be charged.

Spring and autumn are the periods of greatest activity, and it is then that teams are most liable to become low in condition. Horses should be well kept up in autumn, not only because they are hard-worked on the land, but because grass and other green foods are daily becoming less nutritious, and the temperature of the air is falling. Winter is the dead season, which occurs between autumn and spring and occupies December, January, and February. It is a time of short days, often interrupted by frost, snow, and rain; and the work of the team largely consists in carting, and jobs of a more or less "scratch" character. It is therefore advisable to give less corn, and even to venture on straw as a substitute for hay. Horses are liable to "grease", or a swollen condition above the fetlocks, and to become plethoric in habit, and this must be guarded against.

After Candlemas (February 2) the days lengthen and spring sowing begins, so that more liberal allowances of corn and hay are necessary. In May, green rye, trifolium, and early vetches come in, and as soon as this occurs horses begin to exhibit a distaste for dry chaff and hay. Farm-horses look their best in summer. Their coats shine, and they revel in green food, not only in the stable, but in the field. They eat the new hay while carting it, and are fed with barley in the straw while hauling it to the rick, so that during most of the summer they have a good time, and many farmers stop stated allowances of corn for the weeks in which this abundance continues. Lastly comes the post-harvest period, a time of strenuous work, in which wheat land is prepared and sown, autumn cultivation of stubbles is pushed, and potatoes and mangel are gathered in. This, as already stated, is a time in which horses should be liberally fed, and brings us round

196 LIVE STOCK, FEEDING, AND ECONOMIC ZOOLOGY.

again to the winter. These natural divisions of the year are reflected in the dietaries supplied, which may now be set out in order—

Spring (February, March, and April).	Oats, 2½ bushels per week. Hay, 28 lb. (half a truss) per week. Swedes or mangels, 140 to 175 lb. per week.
Summer (May, June, July, and August).	Oats, 1 to 1½ bushels per week. Cut green fodder, <i>ad libitum</i> . Night grazing, or soiling in yards.
Autumn (September, October, November).	Oats, 2 to 2½ bushels per week. Green food, <i>ad libitum</i> , or swedes, after green fodder fails. Hay, 28 lb. per week.
Winter (December and January).	Oats, 1½ to 2 bushels per week. Hay or straw fodder. Swedes or mangels, 140 to 175 lb. per week.

The variations in the above simple dietaries are numerous as, for example, the substitution of maize for oats, which may be recommended when maize is cheap, as it often is. The difference in measure-weight between maize and oats is very considerable, as maize is customarily sold at 60 lb. per bushel while oats are bought at natural weight, or made up to 40 lb. per bushel. Oats are skinny, or husky, and for this reason 2 bushels of maize fully represent 3 bushels of oats. If compared on the basis of market price, 20s. per quarter of oats, is exactly equivalent to 30s. per quarter for maize. On the whole, oats are considered to be a better food for horses than maize, but teams often do extremely well when fed on maize, especially if steeped before it is given. A cask or barrel set on end, and provided with a tap at the bottom, may be charged with dry maize and filled up with water, which is quickly absorbed, and any surplus liquid can be drawn off as a drink, which the horses much relish. Dry, old beans have always been highly thought of by horse feeders, and may be substituted for oats in accordance with their weight, which may be as high as 70 lb. per bushel. Dredge is a mixture of barley and oats grown together, and is considered to be an excellent horse corn, and may be supplied on the same scale as oats.

Bran forms a part of several published dietaries, and among other foods which may be introduced are brewers' grains (wet or dried), rice-meal, linseed, linseed-cake, boiled peas, beans, and barley, etc. Carrots are an excellent addition to winters' food when obtainable. The following additional green fodder crops are well suited for cutting for horses in the stable: Imperial cow-grass, comfrey, lucerne, mixed seeds, Italian rye-grass, and ordinary meadow grass.

**Times for Feeding Work Horses.**—Horses should be fed with corn four times a day—early in the morning, i.e. not later than 5 o'clock; at midday; at 4 to 5 o'clock in the afternoon, and at 8 p.m. They should have access to fodder during the night, and often through the day. A feed of corn weighs 3 lb. Thus a horse may receive 12 lb. of corn a day when on full work, or 84 lb. a week. Where deep

ploughing is practised, as in Lothian, as much as half a bushel or 18 to 20 lb. of oats per day, with hay, is allowed.

The system of feeding entirely on short or manger food is adopted in collieries and railway stables, and is said to be economical of food. The fodder is cut into chaff, and the oats and beans are bruised, or crushed, and all the ingredients are mixed together on a sieve, and placed in the mangers. The same system is also used on many farms.

**Comparative Economy of Horse-power.**—It is impossible to construct satisfactory estimates as to the comparative cost of steam, motor, and horse-power. Besides actual cost, there are considerations which have, so far, left horses in possession of the agricultural field.

1. In the first place it is extremely difficult to make estimates as to cost, because of the inevitable depreciation of steam tackle as soon as it becomes second-hand, a point which does not in the least apply to horses. They may improve in value for a period extending over several years, while machinery must deteriorate in a few months. Machinery is also subject to being superseded by new inventions.

2. Horses need rest, but do not require repair; and, as to accidents, it cannot be said that either they or machinery are immune from them. It is possible to maintain a team of horses in an improving state, and to sell them out at their maximum value, as in fact is often done.

3. Horses are able to work in practically all weathers, and can be ready at a moment's notice. They struggle over bad roads and soft land, whereas in all these circumstances heavy machinery is at a great disadvantage.

4. The cost of horses to a farmer should be viewed on a bedrock principle, because they raise the food to a great extent themselves at prime cost, and farmers often supply their teams with corn and hay which would not bring the highest price on the market. This may be short-sighted policy, but is in accordance with actual practice, and seems to be only reasonable, because a slight discoloration, or lightness in the bushel, does not necessarily imply unfitness as food. It may also be remarked that in estimates as to the cost of maintaining horses, it is usual to charge full allowances of the best oats, hay, etc. at market price, on the basis of fifty-two weeks to the year, whereas, as already shown, the corn and hay vary according to the season, and the severity of the work. The general result is, that horses have maintained their position on the land to a degree which was not expected when steam cultivation was first introduced, fifty or sixty years ago.

**Steam-power** is a valuable aid to farmers, especially of stiff land, but requires a large expenditure of capital and much annual outlay. It is most conveniently used on the hire or contract system at busy times, and when so called in is of inestimable value. On the other hand, there are large areas of land which are better for being rendered firm for corn, trifolium, grass, and other crops, and in such cases freeing the land from the pressure of hoofs is anything but advantageous. Neither is depth of cultivation always to be recommended, so that two of the special advantages of steam cultivation fail to attract occupiers of light and thin soils. The case is quite different with deep clay land, and, on these, unlimited power and freedom from

treading appeal to farmers. It may also be noticed that upon clay soils tillage operations are restricted to dry weather, which entails a pressure of work at certain seasons of the year. There is therefore

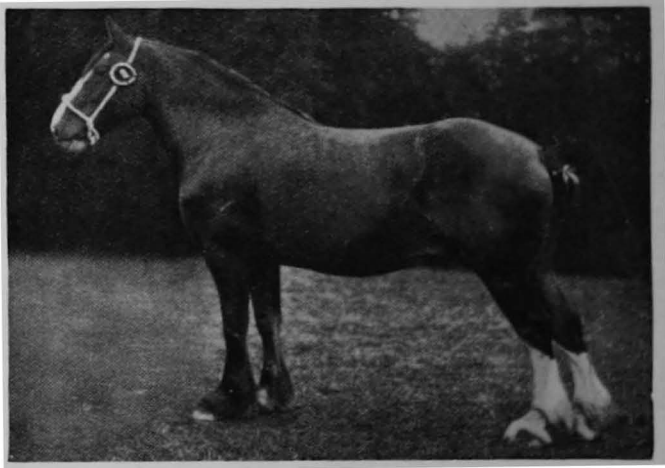

FIG. 72.—Clydesdale Mare.

room for both horse- and steam-power, but the predominating class of land being of fairly free character, horses have up to the present maintained their position.



FIG. 73.—Shire Mare.

**Breeds of Draught Horses.**—There are four established breeds of work horses in this country. (1) *Clydesdales*, which are in high repute in the Lowlands of Scotland. They may be of grey, brown,

or black colour, carry an abundance of hair or "feather" on their fetlocks, have excellent hindquarters, and rather light shoulders. They are rapid walkers, good workers, and require liberal feeding.

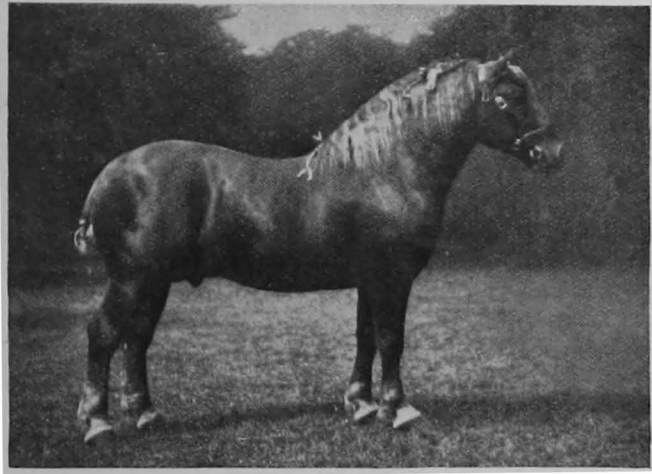

FIG. 74.—Suffolk Punch Stallion.

(2) *Cleveland Bays*, although formerly used extensively for ploughing, are now regarded as more fit for higher purposes. They are bay with black points, free from hair at the fetlocks, and are adapted for a great variety of work.

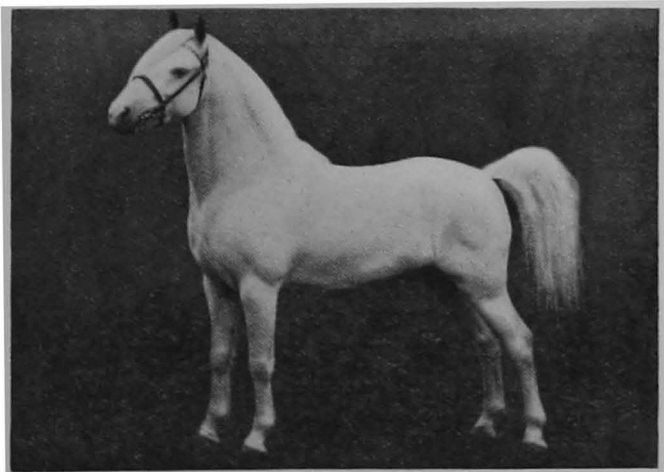

FIG. 75.—Welsh Pony.

(3) *Shire Horses* are extremely popular all over England. They in many respects resemble Clydesdales, but are squarer in form, owing to their deeper shoulders. They vary in colour from grey

to light and dark brown, or black, furnish dray horses for towns, and work on farms. They are largely used for crossing with ordinary mares of no particular breed, such as form so large a proportion of the farm horses of the country; and the effect of repeated crossings with pure-bred Shires has been to gradually convert many ordinary teams into Shires eligible for entry in the stud-book.

(4) *The Suffolk Punch* is highly esteemed in its native county and in East Anglia. They are chestnut and sorrel coloured, with lighter-tinted mane and tail, and carry a white star on the forehead, and white pasterns. They are clean-legged and rather round-boned, very staunch in their work, and much used in all forms of agricultural labour.

These are the principal races of agricultural horses, and all boast influential breed societies.

**Dentition of the Horse.**—It is comparatively easy to ascertain the age of a horse or sheep by an inspection of its teeth, noting the amount

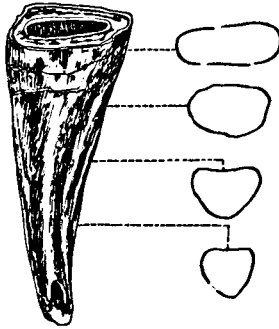

FIG. 76.—Central permanent incisor of Horse, showing shapes of different surfaces presented as age proceeds.

of wear they have received (Fig. 76), but it is more difficult to tell the age of other animals in the same way.

Teeth are bone-like structures originating from cavities in the jaw-bones, termed alveoli, from which they gradually extend, meanwhile forcing their way through the gums into the mouth, where they act as cutters and grinders of food. This admits of the masticated particles being more thoroughly mixed with saliva in the mouth, and so assists in the important work of digestion.

If a single tooth be examined it will be found to consist of a crown and root, or fang, separated by a short nick. A transverse section of the crown will display variations in structure, or substance, which are known as enamel, dentine, and crusta petrosa. On a further examination it is found that there is a channel or cavity through which nerves enter the tooth and associate themselves with a sensitive pulpy mass which occupies the central cavity, decay or injury to the dentine and crusta petrosa being responsible for toothache.

Teeth are classed either as molars or grinders, incisors or cutting teeth, tusks or canines. With but few exceptions the age of a horse is indicated by its teeth. Alterations of a structural character take place each year from birth up to the sixth year; therefore there need be no real doubt as to the age of a horse up to this time, providing of course that natural growth has not been tampered with in any way. Two sets of teeth are developed, namely the temporary or milk teeth, and the permanent teeth. A foal at birth has two central temporary incisors visible in each jaw, and at the end of 6 or 8 weeks four temporary ones, including the two lateral incisors in each jaw. The yearling is then furnished with six incisors in each jaw.

The foal is usually born with two, or sometimes three, temporary molars, or back teeth, in each jaw, or in all twelve temporary molars. When about 12 months old another pair, but this time permanent ones, appear, and before the completion of the second year a fifth pair, also permanent, appear. At the age of 2½ years the two anterior temporary molars are replaced by permanent teeth, and between 3 and 4 the remaining or temporary molar is similarly replaced, and shortly after the last or sixth permanent molar begins to show itself. Thus, when a horse has reached the age of 4 years a complete set of twenty-four permanent molars will have made their appearance. After this period the molars are rarely referred to in determining age, their position rendering them difficult of examination.

To return to the incisors of the yearling, it will prove instructive to compare his mouth with that of a 2-year-old colt. In the latter case the teeth show considerable signs of wear, and appear smaller, and have also lost their milky whiteness. In the yearling the corner teeth are mere shells, devoid of an inner wall, all the teeth being in juxtaposition one with another. The teeth of the 2-year-old stand wide apart at the necks, due to the gradual development of the jaw, while the inner wall of the corner teeth will be observed to have grown up level with the outer wall. At 2 years 9 months the horse sheds two central temporary incisors, and two permanent incisors will be observed pushing up to occupy their place. Thus at 3 years of age the jaw contains two central permanent incisors and two temporary incisors on either side. At about 3½ years of age the lateral incisors are shed, and permanent incisors occupy their place, and are well up for wear at 4 years.

At 3½ years it will be observed that the corner incisors are mere shells, and the inner wall does not grow up to the level of the outer wall until nearly 6 years are reached; thus the absence of this wall distinguishes the five from the six year old mouth. The canine teeth or tusks, which are present in males but absent in females, appear as permanent teeth at about 4½ years, and frequently at 5; further they often appear later in the upper than in the lower jaw. Marks, or as they are more correctly called, infundibule, are to be seen on the crown surfaces of the incisor teeth. The mark is a very peculiar hollow, extending in a new tooth to about half an inch down the temporary, and somewhat deeper down the permanent incisors. The appearance or disappearance of these marks is largely instrumental in determining the age of a horse after the sixth year.



When an incisor is newly developed, the cavity, although small, affords a receptacle for minute proportions of masticated food, together with the juices extracted from other foods, which, when combined, give a dark colour to the dentine and to the enamel coating of the tooth. As the tooth wears down, the hollow, together with the dark mark, gradually disappears, when the mark is said to be worn out.

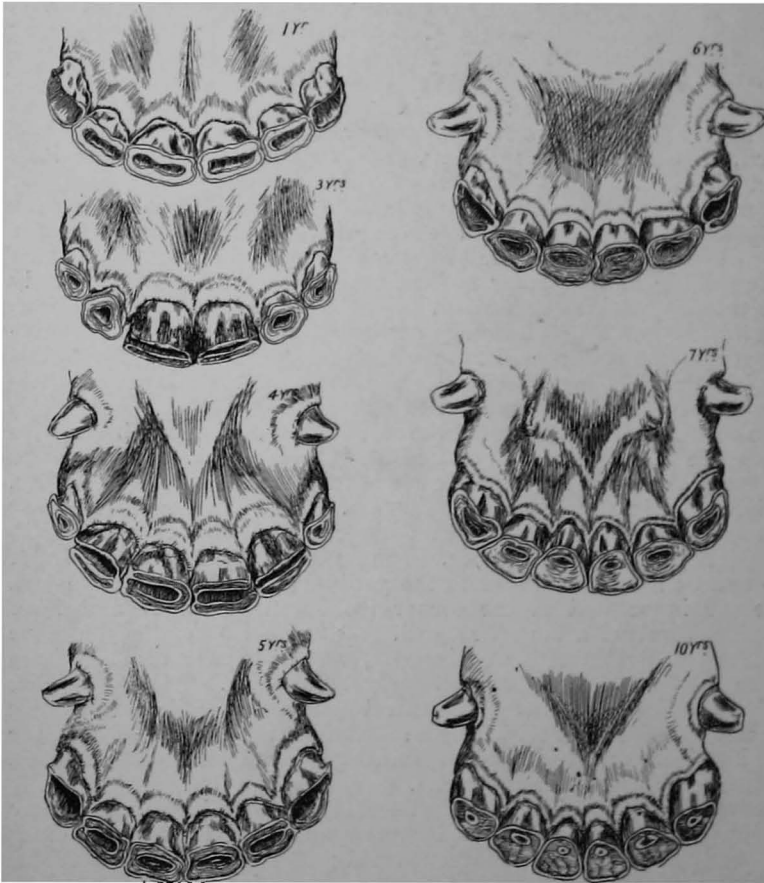

FIG. 77.—Dentition of the Horse, showing appearance of incisors from 1 to 10 years o.d.

The time taken for the mark to wear out will naturally vary somewhat in different animals, according to constitution and manner of feeding. Generally speaking, however, all the marks are plainly visible in horses from 3 to 5 years of age (Fig. 77). At 6 years the marks are beginning to wear out of the central incisors. At 7 years the marks of these incisors are beginning to go, and at 8 years they will be

gradually disappearing, while at 9 years the marks are not usually discernible in any of the teeth. For some two years or so after the mark has disappeared in each tooth, the enamel which lines the bottom of the original hollow, assumes an irregular, star-like form, which gradually decreases in size with the wear of the teeth.

At from 12 to 13 years all trace of the enamel has usually disappeared, even from the corner teeth. There are, of course, many exceptions, due to various causes, the principal of which is the habit which some horses acquire of biting their mangers; this will have the effect of wearing down their teeth very rapidly, whereas in cases

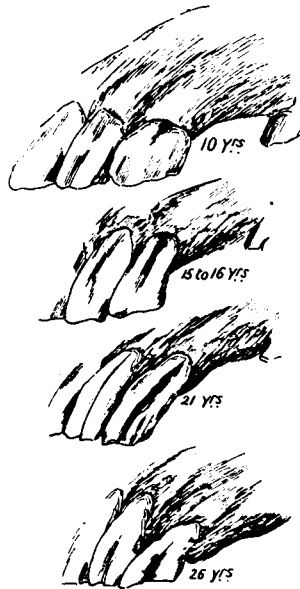

FIG. 78.—Galvayne's mark.

of parrot-mouth—that is, the upper jaw overlapping the lower jaw—the marks may remain many more years.

Galvayne, a well-known Australian authority on dentition of horses, gives a fairly reliable guide in determining the age of old horses; his theory is based on the groove (Fig. 78) which appears on the upper corner incisors of horses at 10 years of age, and which extends itself about half-way down the tooth in the fifteenth year, while in the twenty-first year it reaches right to the bottom of the tooth. In aged animals marks are often burnt in the corner incisors by means of acid or hot iron, with a view to deceive the novice. This practice,

sometimes called "bishoping", from the name of the man who first introduced it, is still practised in some parts by individuals who wish to pass off an old horse as an 8-year-old.

Triangularity is another fairly accurate means of determining advanced age, but it calls for a great deal of careful observation, and is based on the amount of wear the crown receives. Although the teeth decrease in lateral breadth, they increase in thickness from front to rear all the way from the crown to the root. From 6 to 8 years old the teeth are all broad laterally at their upper surfaces, and up to this time the age of the animal can be very accurately determined by the marks. At 9 years, when the marks begin to fail, two central incisors, which come up at 3 years, begin to assume a triangular form. At 10 years the two next teeth show similar triangulation, while at 11 years the corner teeth also become triangular; at 12 years triangulation is still more pronounced in all the teeth. This characteristic continues to a more marked degree as the teeth wear down, when in very old horses the depth from front to rear exceeds the lateral width of the teeth. There are numerous other changes which may be observed by those who are continually among horses of all ages, but those which have already been mentioned will serve as useful guides to the novice and the buyer who is not over familiar with this subject. In old horses the incisor teeth project instead of being almost perpendicular.

The tusks are of great assistance in determining age, as they usually appear in a slight degree at from  $3\frac{1}{2}$  to 4 years, they continue to develop until 5 or  $5\frac{1}{2}$  years is reached. The tusk may be described as a somewhat elongated tooth of peculiar shape, having a sharp or hooked edge, due to the enamel overlapping the dentine. Although this tusk takes no active part in mastication, it nevertheless becomes worn, and after 7 years the point assumes a somewhat blunt or rounded form; meanwhile, the enamel wears off, thereby imparting a yellowish colouring to the dentine below. Unlike other teeth the tusks do not increase in length, but become shorter and shorter each succeeding year, until in very old horses they are found to have worn down level with the gum.

## CHAPTER II.

### FARRIERY.

WHILE a farmer must necessarily become familiar with many of the diseases peculiar to live stock, he cannot reasonably be expected to possess other than a slight knowledge of the anatomy and functions of the many organs of the body. However strong the physique of a horse, the animal is of little value unless its legs and feet are sound ; and the sooner we become familiar with the anatomy of the foot, the diseases to which it is subject, and are able to detect between good and bad shoeing, the more reliable will be our judgment.

**Anatomy of the Foot.**—The bones of the foot are situated in the centre of the hoof (Fig. 79), and are surrounded by soft sensitive tissues, whose function is the production of horn. At the lowest extremity of each limb the small coffin or pedal bone is found ; and the navicular bone, together with the lower extremity of the short pastern or coronet bone, form the coffin or pedal joint.

*The Coffin Bone* may be described as a pyramid with a hollowed-out base, placed so as to cause the point or tip to be wedged into the toe of the foot, as shown in Fig. 80. The sides or wings gradually extend upwards, and the heel of the foot is left entirely devoid of bony formation.

*The Navicular Bone* is small and boat-shaped, and is to be found at the back of the central part of the coffin bone. It acts chiefly as a roller for the flexor tendon, which curves round its back prior to its contact with the coffin bone.

*The Coronet*, or, as it is sometimes called, the short pastern, has a rounded base, which rocks to and fro in the socket, or hollowed cavity at the base of the coffin bone. The surface parts of these two bones are in indirect contact, but are protected by a layer of gristle (*Articular cartilage*) about one-eighth of an inch thick, and the whole articulation is bathed in "joint oil" (*Synovia*), a lubricant which causes smoothness of movement.

*The Lateral Cartilage* is a large springy piece of gristle, extending from the top of the coffin bone, along each edge, and curving round to the heel behind. In fine-skinned horses its outline can be clearly discerned running along the sides of the coronet, and by pressing hard on its edge towards the heel, its "spring" may be easily demonstrated.

*Ligaments* extend from bone to bone, holding them firmly in position, and at the same time allowing entire ease of movement. One ligament (*Extensor pedis tendon*) extends down the front of the leg, and spreads out over the pastern or top of the coffin bone.

At the back of the foot there are two ligaments, one (*Flexor perforans tendon*) reaching to the coffin bone, and the other (*Long inferior sesamoid ligament*) to the coronet.

*The Frog Pad.*—At the back of the foot, occupying the cavity which lies between the wings of the coffin bone and the lateral cartilages, is a thick tough elastic pad, known as the frog pad or sensitive frog, the object of which is to act as a cushion in lessening shocks to the column of bones.

*The Wall or Crust* is the term applied to the outer covering of the foot, the "bars" of which turn in at the heels, and continue down each side of the frog (Fig. 81). On the upper edge of the wall is a groove

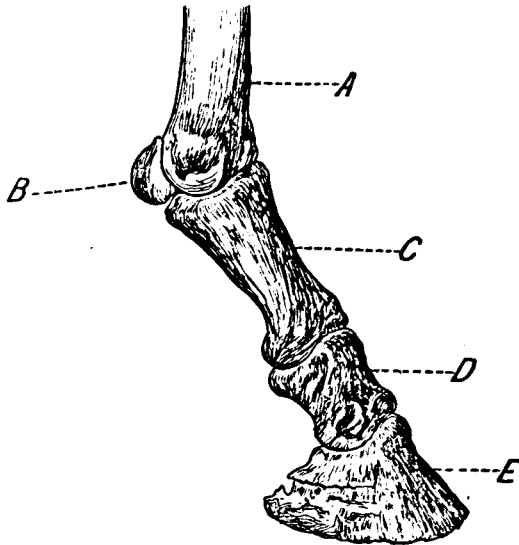

FIG. 79.—Anatomy of the Horse's Foot. A. metacarpal bone; B. right sesamoid bone; C. great pastern bone; D. small pastern bone; E. coffin bone or *os pedis*.

known as the coronary cavity in which fits the coronary, a species of fatty band, the object of which is to secrete the material necessary for the formation of the horny growth which builds up the wall. The latter is of uniform thickness below this groove, gradually getting thinner towards the quarters and the heels. A number of horny "leaves" or laminæ are found lining the inner surface of the hoof projecting inwards, the conformation of which is similar to the fleshy leaves which cover the coffin bone, and into which the laminæ dovetail. A thin band or ring known as the periopic ring or frog band, runs round the upper edge of the wall and secretes the periople, which becomes very prominent when the foot is soaked in water.

*The Sole* is similar in shape to the under surface of the pedal bone, being slightly concave towards the centre. The insensitive sole grows from the sensitive sole above it, as may be seen in the illustration (Fig. 80), and when it attains a thickness of from a quarter to five-eighths of an inch, it separates from the under surface of the sole and becomes, in a sense, detached from the foot.

*The Frog* is a wedge-shaped piece of horn, the broad end of which fits in between the heels. The horny or insensitive frog grows from the sensitive frog above it, and is nature's chief provision against concussion.

The above notes give as concisely as possible the general formation of the horse's foot, and when the anatomy of this portion of the horse is thoroughly understood the student will be provided with a good foundation upon which to build his practical knowledge of farriery. Sound feet and limbs are of the utmost importance.

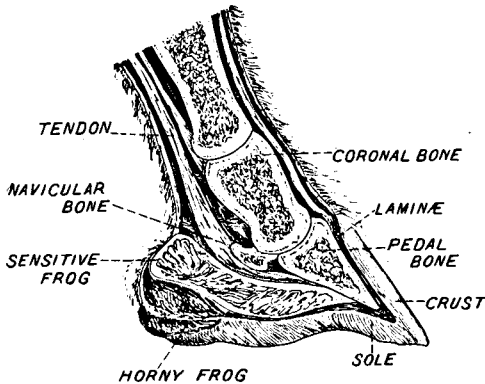

FIG. 80.—Section of Horse's Foot.

**Manufacture of Shoes.**—Shoes are made both by hand and by machinery, the first being preferable, because the shoe is better adapted to the foot, and the iron is better tempered, while the nail holes can be regulated as thought best. For hand-made shoes the best material is bar iron, or better still, old shoes turned over and welded up. The hammer and sledge must be used with considerable effect to render the shoes hard and tough, and of a steely texture. Ordinary riding horses, hunters, and carriage-horses, require to be shod with a tolerably light shoe, wide enough to cover the weight-bearing structure of the foot. The shoe must be of uniform thickness and width. The thickness depends largely upon the particular structure of the foot to be shod, but in all cases, it should be as thin as is compatible with its wearing for one month. Fore-shoes are generally seated out on their foot surface, and in some cases are made slightly concave.

For heavy cart-horses, employed chiefly on the farm, shoes of a weight of about 4 lb. are preferable, while in many cases caulkins are used on the outside heels of the hind-feet as a stay to the foot on heavy retentive land. The other, or inner heel must of course be raised to a corresponding level, and in no case should caulkins be applied for the fore-shoes. Seven nails are usual for a well-fitted fore-shoe (three on the inner, and four on the outer edge), but five are quite sufficient and often preferable to seven. For the hind-shoe, six or seven nails should be used. The use of machine-made shoes is not to be commended, as they do not receive that thorough hammering and welding which is so essential for the production of a hard, tough, and unbreakable shoe. It will also be found in this class of shoe that the nail holes are all pitched at the same angle. On a careful observation of the foot, however, it will be seen that the wall is more vertical in the quarter than it is in any

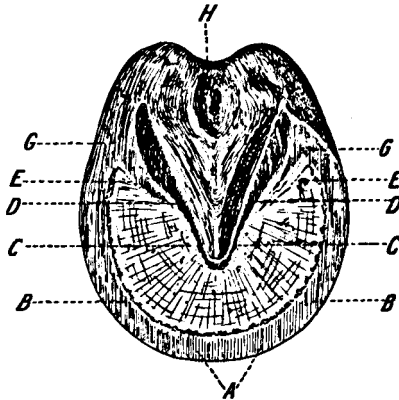

FIG. 81.—Ground surface of Horse's Hoof. *A*, toe; *B*, crust or wall; *C*, sole; *D*, bars; *E*, seat of corn; *F*, frog; *G*, heels; *H*, cleft of frog.

other part of the foot, and hence this uniform angle of the holes in a machine-made shoe, is not desirable.

The use of steel shoes still finds many supporters, but the great disadvantage in their use is that they become smooth and slippery on the surface, which renders them dangerous on stone or wood pavings.

**Preparing the Foot.**—The farrier cannot pay too much attention to the preparation of the horse's foot before fitting on the shoe. There are numerous points to be considered in order to ensure a well-shod foot, and the most important of these are the nature of the work undertaken by the horse, and the variety and quality of the land, or road, over which it has to travel. The foot must be carefully examined before preparing it in order to notice any peculiarities that may be evident from the wear of the old shoes. Among these may be mentioned forging, stumbling, brushing, or interfering, speedy cutting,

etc. Carefully examine the feet so as to see that they are evenly matched in pairs and are level and not "odd-footed", and whether there are high or low heels, long toes, dropped soles, or contracted heels. When these points have been noted, the preparation of the foot may proceed. With a rasp remove from the ground surface of the wall any superfluous growth of horn, care being taken at the same time to lower the wall at the toe. The under-surface must then be rasped quite level. All sharp edges should be removed, as they tend to split the crust. The foot is then ready for the application of the shoe.

**Management of Colt's Feet.**—Careful attention must be given to the feet of the young colt from the time of foaling to the fitting of its first pair of shoes. The feet should attain a regular and even growth, and should be perfectly matched in pairs. Great importance attaches to the angle at which the feet grow, the proper inclination of which should be similar to that of the pastern when standing on level ground. Colts reared on hilly ground are very liable to exhibit irregular and uneven feet, and if this defect is neglected, the foot and the joints above it become permanently deformed, and the horse is practically ruined. To avoid this, regular attention must be paid to the state of the feet each month, and the rearer should remember to keep the toes at a uniform length, at the same time rasping down the heels in order to encourage frog pressure. The first shoes must not be fitted to a young colt until he has been taught to lift his feet in proper order; a loud bullying tone must never be used to a young horse, but he should be treated with every indulgence until he learns that he is not to be hurt. Any sign of obstinacy must, however, be repressed at once.

**Shoeing Farm-horses.**—Many farm-horses, especially those employed on small holdings or allotments, are frequently worked both on the land and on the road, and for this purpose a special method of shoeing must be adopted. A horse of this class must be shod every month, regardless of the fact that its shoes may not appear to require removing. This regular treatment of the foot becomes more essential when the horse is employed solely on soft, retentive land, as this gives rise to a somewhat faster growth, rendering the feet liable to become misshapen.

When preparing the foot for shoeing, diseased horn, or hard lumps, must be cut out of the under-surface of the sole, but care should be taken to prevent undue paring; the sole, when fitted with a shoe, should be as near to the ground as possible. When the shoe is fixed to the foot it should run flush from heel to heel, with the outer edge of the wall, and should be about  $1\frac{1}{2}$  in. in width, and  $\frac{1}{2}$  to  $\frac{3}{8}$  in. in thickness, being a little longer and broader at the heels than at the other parts. The hind-foot should be prepared in a similar manner, and the shoe best adapted for this purpose will have a caulkin on the outer heel, and a wedge heel inside; a horse having low heels will be better with a shoe having caulkins on both heels. Animals employed solely on the farm do not require caulkins, as these projections sometimes give rise to ugly wounds on the coronet if two horses blunder into each other in turning about, and may cause



side-bones, but animals employed solely on road work can, with advantage, be shod with shoes having caulkins on both heels, as these form a means of obtaining a foothold when descending steep hills, and also serve to lessen the strain on the back tendons.

**The Shoeing of Hunters.**—The shoeing of hunters requires great care and experience, as well as a particular form of shoe. The varied character of the ground over which a horse of this class travels renders it extremely desirable that suitable shoes should be applied, and those recommended are concave on the under-surface and are fullered with seven nail holes, which should be placed a little nearer the heel than in ordinary cases, in order to allow for the natural spring of the foot. The fore-shoes must be well tapered at the heels, and in the case of the hind-shoe, a caulkin should be raised on the outer heel, and a corresponding wedge on the inner heel. The hind-shoe must not be fullered at the toe, as this may prove dangerous should the horse overreach. For a hunter with flat feet, or a drop sole, the ordinary fullered shoe, seated out on the foot surface, having the under-side hollowed out with a file, and the heels well tapered, is to be preferred.

**The Shoeing of Hackney or Carriage Horses.**—These horses, being used chiefly for road work, require a broader webbed-shoe than hunters, and should also be fitted longer at the heel. Six nail holes will suffice for this class of shoe. Ordinary roadsters should be shod with a plain stamped shoe, if under  $5\frac{1}{2}$  inches in width. If this dimension is exceeded a fullered shoe must be employed. Should the horse prove a stumbler, it will be advisable to roll or "dubb" the toe of the shoe, which must be kept quite short. In the case of a forger, the use of a concave shoe is to be recommended, and the use of caulkins is to be condemned, as they tend to aggravate this fault.

**Diseases of the Horse's Foot.**—*Laminitis* is a term applied to inflammation of the horn-secreting structures, and is generally observed to follow chills, digestive disorders, or an undue amount of work imposed on an ill-conditioned animal. The two fore-feet are chiefly susceptible, though all four may be affected at the same time; the horse experiences great pain and becomes very lame. Laminitis may be traced to many sources, but the most numerous may be enumerated as follows: A sudden change in the nature of a horse's work, as for example from farm to road work; working a horse on long journeys over hard and stony roads, immediately after it has been resting for three or four days on ordinary corn diet. After the animal has been resting for some time the circulation of the blood is less rapid, and consequently the lower limbs lose their customary strength and suppleness, and if an undue strain is placed upon them in this weakened condition, laminitis is bound to make its appearance. An excessive quantity of corn, especially when fed to forest ponies, is also liable to induce it. The symptoms of fever in the feet usually appear in the morning after the horse has been confined in a hot stable during the night; the animal shows a great disinclination to move, and endeavours to walk upon his heels or frogs in order to ease the pressure upon the laminæ; the fore-feet become very hot and tender, and in order to alleviate this the hind-feet will be planted well forward so as to ease the strain.

In treating this disease the fore-shoes must be removed, and a portion of the wall lowered just beyond the level of the sole. This will relieve the wall of a considerable amount of strain, and will enable the sole to bear its share of weight. The horse should be halted if possible in running water for an hour or two. Large cold poultices must be applied three or four times a day, and a low diet of bran mash given until the animal is fairly strong again. When thoroughly recovered, the horse should be shod with bar shoes, and great care must be taken in bringing him back to work, avoiding any sudden vigorous exercise, and observing judicious stages in resuming full work. This treatment will, however, only suffice for mild attacks, and when a serious case of laminitis develops a veterinary surgeon should be called in.

*Corns* are generally developed in horses with low weak heels, flat or contracted feet, and diseased frogs. They may be described as a bruised portion of the foot lying between the wall and the angle of the heel, and will generally make their appearance in cases where the foot has been badly prepared or the toe left too long. Among other causes may be mentioned excessive lowering of the heels, upon which an undue strain is thrown, and also the use of badly-fitting shoes. The symptoms rapidly develop, the animal goes lame, and the foot, generally on the inside heel, becomes very hot and tender. In treating a horse for corns, the shoe must be removed, and all diseased horn cut away. Excessive growth of the toe must also be removed with the knife; and the heels, if too high, must be lowered. To relieve the animal of pain, immerse the foot in a hot bran poultice, and when sufficiently recovered, it can be shod with a shoe thinned on the inside heel, or, if corns are found on both heels, the use of a bar shoe is to be recommended.

*Seedy Toe* is an affection of the laminae, or frontal part of the foot, running upwards from the toe to the coronary band. The horse is sometimes lame, and may be observed to "point the toe" when resting. There is also a considerable amount of heat in the foot, and frequently a formation of pus develops. Remove the shoe and cut away all diseased parts, afterwards soaking the foot in a bath of copper sulphate solution. When the horse is free from pain, have him shod with bar shoes, and fill in the cavity with Stockholm tar.

*Side-bones* (Fig. 82). This is a disease which generally affects the fore-feet, and consists of the ossification of the lateral cartilages. Heavy horses which have these cartilages completely ossified are of little use for rapid work, but when only one cartilage is affected, or when the animal is worked on soft ground, its action appears quite normal. The chief symptoms to be observed are the presence of great heat around the coronet, and loss of spring or suppleness in the cartilages. The latter become hard and increase in size, and will be found to stand up above the coronary band.

*Thrush* is an affection of the sensitive frog, the protuberance of which may be seen through the cleft. An unclean stable is frequently the cause of this disease, as it stands to reason that when a horse is constantly standing in filth, urine, and dirty litter, the frog becomes quickly affected. Horses with feet and frogs of

a naturally weak structure, and also animals that have had their feet badly prepared for shoeing, are very susceptible to thrush. The disease will also make its appearance if the heels have not been sufficiently lowered to allow of frog pressure, as unless this precaution is taken, the frog perishes, and rots away for want of use.

In treating thrush all diseased or malformed horn should be cut away, and the foot immersed for an hour or more in a bath composed of 5 per cent solution of copper sulphate. The foot must be cleaned with tow and afterwards dressed with calomel powder, and it must be born in mind that, to prevent the reappearance of this disorder, the foot must be kept perfectly clean and free from all dirt and moisture. With a view to restoring the parts to healthy action, pressure is necessary, and this is best effected by lowering the wall at the heels and shortening the toes. The use of tips instead of shoes is also to be recommended, as this gives the frog extra pressure, and in a little while the organ will regain its normal healthy condition.



FIG. 82.—Bone of hoof showing side-bones (A, A).

*Canker* is an unhealthy and putrid secretion of the sensitive frog and sole, and usually has its origin in neglected thrush. It is most common among heavy cart-horses. The discharge which is secreted from the frog is particularly offensive to smell, and is almost colourless; the frog itself becomes enlarged and covered with spongy growths of a fungoid nature. The treatment of canker consists in the first place in removing the whole of the affected horn and fluid by scraping or excision. When this is done the exposed surface should be dressed with a strong caustic such as nitric acid, sulphuric acid, chloride of zinc, or copper sulphate. Subsequently the sole should be securely packed with tow and the whole foot enclosed in a leathern boot. After two days the dressing may be removed and within a week the sole will develop a healthy growth of horn. The dressings should, however, be continued, and as soon as the horse can bear the application of shoes, they should be fitted, as it is much easier to dress the feet when the shoes are on.

*Sandcrack* is a fissure in the wall or crust of the foot, and usually appears on the inside of the fore-foot, and on the front or toe of the hind-foot. In most cases the appearance of these fissures may be attributed to a natural brittleness of the wall, more often than not, due to the evil practice of rasping the crust. Contracted heels and flat or sprawling feet also are a cause of this disease. In treatment, it is well to remember that a division of the horn or wall has taken place, and that the object in view is to promote a fresh and rapid growth of new horn from the coronet. With this object the coronet must be sharply blistered, and a day or two afterwards the foot should be immersed in hot water three or four times daily, great care being taken, however, to keep the blistered skin free from moisture. The coronet will heal in about a fortnight, and the horse may then be put to work, but should be shod with tips in preference to bar shoes.

## CHAPTER III.

### CATTLE.

**Live Stock as an Aid to Agriculture.**—The question of arable *versus* pasture land is likely to be much discussed in the near future. Its solution must depend upon a complete knowledge of the varying descriptions of grass land, for many pastures are much more remunerative in their present state than if converted under arable land.

It is the heavy expenses connected with tillage, combined with the low price of corn, which have led landlords and tenants to lay down much land in grass—and it is one of the results of the free importation of wheat. We cannot have cheap corn without “raising the margin of cultivation”. So far as *extensive* cultivation is concerned, the only alternative seems to be grass, or afforestation; and *intensive* cultivation can only be carried out in populous localities where labour is plentiful, and there is a ready access to markets. Every small-holder demands land near a town or village. Those who would solve the land question by breaking up large farms and converting them into small holdings lose sight of the enormous differences in the productivity of land, and the large amount of capital which would be necessary to bring many millions of acres up to the required standard. They in fact do not take an economic view of the matter, but rather a sentimental one. This being so, and likely to remain so, the only practical use for lands distinctly below the margin of profitable cultivation is grazing, or plantations of larch and other kinds of timber.

**Two Principal Classes of Grass Land.**—It therefore appears that there are two principal classes of grass land which may be briefly described as good and bad, united by many intermediate qualities. Good grass land may or may not be left in its present condition, and if of rich loamy character, it has often been converted into tillage with advantage. On the other hand, good grazing lands, underlaid by clay of great depth, and possessed of great retentive power as to moisture, are unquestionably better under grass. They may require drainage, but in many cases are naturally drained. They are rich in nitrogen and well stocked with organic matter, but the dissipation of the nitrogen in the form of free gas, and the rapid decomposition and disappearance of the organic matter under the influence of tillage, would speedily rob them of these two advantages. Such lands form the basis of many of the most valuable bullock and dairy pastures, and, unless in the immediate neighbourhood of towns, they are adapted for extensive occupation, rather than for small holdings.

The poorer descriptions of grass land are best illustrated by heaths, downs, fells, sheep-walks, forest-lands, etc. They form a large proportion of the total area of this country, and are adapted for rough grazing, and for breeding. It is true that patches of such land are to be seen under intensive cultivation in the form of nurseries and gardens, but these are selected portions, and the sites of hamlets and villages have evidently been largely determined by the superior quality of the immediately surrounding land. The outlying areas are, however, too poor for profitable tillage, and unattractive as dwelling-places. They are not likely to come within any scheme of colonization with a thriving peasantry, and will probably remain as they are as long as cheap food can be imported from abroad. Raising the cost of living can scarcely be the object of any class of land reformers, but without higher prices, poor land cannot be profitably cultivated. We therefore arrive at the conclusion that grass land is an important national asset, and this enables us to pass on to the consideration of

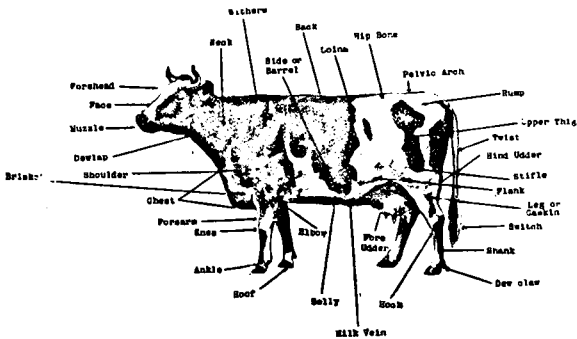

FIG. 83.—Diagram showing points of the Cow.

live stock, without feeling that cattle and sheep are in any sense rivals to the human population—cumbering land which man should occupy, and consuming food which would be better replaced by corn and vegetables.

The close relation which exists between live stock and fertility is one of the most important facts in agriculture. It is universally recognized by all farmers, so much so that the degree of fertility of a farm may be roughly measured by the head of stock it maintains. Plenty of live stock is the best guarantee of good farming, and the foundation of rotations of crops. This is not the place to discuss the merits of farm-yard *versus* artificial manures, but there is a school of thinkers who regard manuring by live stock as clumsy, wasteful, slow, and expensive. Such people see in artificial manures a more scientific and direct means of keeping up fertility, but do not appear to recognize the direct incentive of profit in stock-keeping. The more profitable the stock, the less does the residual manure cost,

and, so true is this, that breeders of high-class animals scarcely take food into account as an expense, and regard the manure as a by-product obtained at no cost at all. Artificial manures fail in organic matter, and also in mechanical effects upon the land, and the verdict of the vast majority of good farmers, who it may be remarked also use large quantities of artificial manures, is in favour of live stock, which also encourages another equally valuable source of fertility, namely the importation of purchased foods.

It may be allowed at once that the manure is an important consideration in reducing the cost of the manufacture of beef and mutton, and that without it the animals do not always pay their expenses. In such cases the manure is supposed to make up the difference, and the cost of its production will be found to vary inversely with the success of the grazing enterprise. This may not



FIG. 84.—Shorthorn Bull.

always be satisfactory, but experience appears to have settled the matter in favour of live stock, judging from the perseverance of so many agriculturists in maintaining it on their farms.

There are at least twenty-six distinct races of cattle in Great Britain and Ireland. Most writers on the subject devote much of their space to descriptions of breeds, and shows are held in every district of the country in which farmers and students have opportunities of seeing excellent specimens of most races. It is true that there are breeds which are local in distribution and only to be seen at the Royal and other leading shows, but the subject is so fully dealt with in many works that we may safely refer readers to them and deal more particularly with cattle management.

There are additional reasons for avoiding minute descriptions of breeds, namely, that the interest of farmers, and even of breeders, chiefly centres around their own particular breed of cattle or sheep.

Also, as previously remarked, the broad lines of management are similar, if not identical, for all breeds, and comparative merits are matters of keen controversy. Our object is to assist those engaged in agricultural pursuits, and the special breed of stock kept is, we submit, in many cases already fixed by locality.

There is, in fact, more to say on management than on breeds, especially as management involves many *classes* of stock as distinct from breeds. The *class* of stock kept is of more importance than the breed, and there are probably more classes of stock than there are breeds. A farmer's success depends upon keeping the right sort of stock for his soil, climate, markets, etc., and, in order that readers may appreciate the great differences between them we append a

*Schedule of Different Classes of Cattle.*

- |                                  |  |
|----------------------------------|--|
| 1. Large bullocks for fattening. | 7. Young dry stock.                      |
| 2. Small bullocks for fattening. | 8. Pedigree stock.                       |
| 3. Finishing half fat bullocks.  | 9. Hardy Irish, Scotch, or Welsh cattle. |
| 4. Heifers, for fattening.       |  |
| 5. Cows, for milk.               | 10. Channel Island (Jersey) cattle.      |
| 6. Heifers as in-calvers.        |  |

If a farmer attempts to graze big bullocks on land only fit for fattening heifers; if he perseveres in fattening cattle on land only fit for dairy cows; or if he keeps milking cows where young stock or in-calf heifers ought to be maintained, he is making a cardinal error which no attention to minute points of management will repair. It is also of importance that in purchasing cattle of any description they ought to be brought off inferior land and from harsher situations, as a richer and more salubrious position always tells favourably upon animals.

Applying these rules, it is only the very best pastures which will fatten large bullocks. Such lands are to be found in almost all counties, but especially in Yorkshire, Northampton, Lincoln, Norfolk, Leicester, Warwick, and Somerset. These grazing lands are situated either upon deep rich clays, such as the Lias, on red sandstone soils as in Shropshire and Hereford, or as alluvial soils in the fenlands of East Anglia. They are capable of carrying an ox and a sheep to the acre during the grazing season, or from the middle of April to the middle of September, i.e. about twenty weeks. During this time oxen will put on 14 lb. of beef a week, which at 7*d.* per lb. equals £5 6*s.* per acre. The value of the grazing for the remainder of the year is difficult to estimate, but ought to be worth from 20*s.* to 30*s.*, so that a total yield of from £6 6*s.* to £6 16*s.* may be expected. This is less than could be obtained from the same land under tillage, but the expenses are less, and the result is that neither landlord nor tenant would wish to see it broken up.

There are many degrees of grass land, from the rich pastures just described to hill and mountain grazings in which the amount of stock carried is not calculated in terms of head per acre, but of acres per head. Medium qualities of land are devoted to dairying and raising young stock, and the worst are either employed for hardy cattle or ewes.



## CATTLE BREEDING.

Bearing in mind the three divisions of breeding, rearing, and fattening, we proceed to take them *seriatim*. The breeding of cattle is controlled by the same laws that govern the procreation of all other animals, and apparently plants. It involves the study of heredity, environment, and includes many subjects of great difficulty and complexity. It is, moreover, eminently controversial, especially as regards the transmission of acquired characters, and the effects of surroundings. The fundamental facts with reference to the germ plasm are still under discussion, and the recent revelations of Mendelism have in a great measure upset the rough and ready principles which guided the early breeders. It would, however, carry us far beyond the limits of this work to enter upon the profundities of heredity, and the effects of cross-fertilization.



FIG. 85.—Shorthorn Cow.

These subjects are occupying the attention of our greatest physiologists, and bristle with technicalities. They are only mentioned in order to indicate the enormous difficulties which surround the subject, and the errors which may easily be propagated and practised by breeders. Take, for example, telegony, or the "infection" of a female (or male) from previous matings with an impurely bred sire or dam; we are now assured by Professor Cossar Ewart of Edinburgh that "breeders may in future disregard the 'infection' doctrine". The same doubt hangs over the effects of impressions received through the eye or mind at the time of conception, such as Jacob trusted to in breeding his ring-straked, spotted, and speckled sheep; or as McCombie, the great breeder of black Aberdeen cattle, feared when he painted all his gateposts black, and would not allow

a white animal on his premises. There are also the effects of environment, and of acquired condition of the body, such as poverty, filth, tuberculosis, etc., all of which may or may not affect the offspring at the time of birth.

These are important questions, not only affecting animals but human beings, for it is now disputed how far drunkenness, vice, criminality, and many other tendencies are transmissible. The entire subject of heredity, and the transmission of acquired properties is in the melting-pot, and the two are so closely related that it is impossible to separate them. Take, for example, the effect of food and situation upon horses, in gradually reducing their size to that of ponies; it is difficult to believe that the acquired character is not transmitted; for if it is not, ponies would breed horses as soon as they were released from the special conditions which produced them—the germ

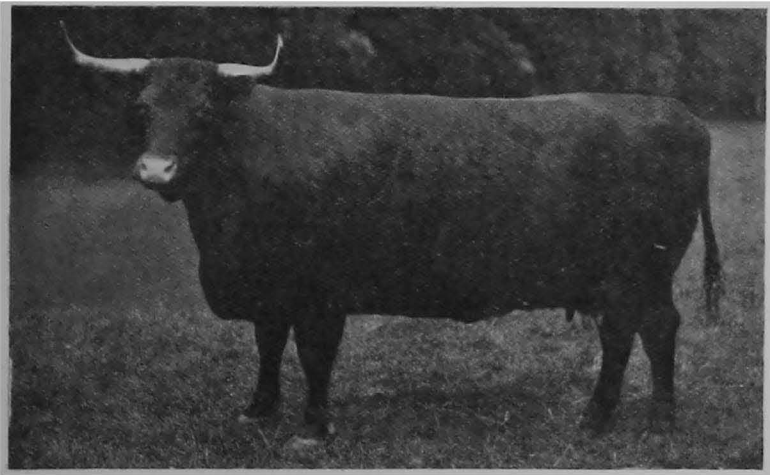

FIG. 86.—North Devon Cow.

not having been affected by privation through successive generations. The experience of breeders is certainly in favour of great care with reference to management. Pampering is considered to undermine the power of resistance to external conditions; and bringing up in the open field is believed to foster hardihood in stock. So it undoubtedly does, if we may judge from results; but the matter is complicated, when it is urged that the effect is upon the individual rather than upon the race, and, that the germ-cells are protected so completely, as to be beyond the effects of surrounding conditions.

Mendelism sheds a flood of light upon many problems connected with breeding, and explains why apparently pure-bred animals may appear from hybridized parents. When a purely bred white race is crossed with a purely bred black one, the fertilized germ must be influenced by both parents. When, however, the hybridized products

are crossed, it is held that both parents contain both pure black and pure white germ-cells. Fertilization may in this case be effected in three ways: (1) by the union of two black germs one from each of the hybridized parents, in which case the result will be a pure black product; (2) by the union of two white germs, in which case a pure white individual will be the result; or (3) a black and a white germ-cell may unite, and produce a parti-coloured product which resembles both the hybrid parents. Thus in the third generation, counting the original cross as one, the progeny may be either pure black, pure white, or mixed. It is further found that such pure blacks and whites may continue to breed truly; or that the hybrids may breed hybrids; or revert to the black and white types, by a repetition of the above process.

In order to obtain an idea of the views of physiologists upon the genesis of individual life it is necessary to study the germ-cell with its chromosomes, chromosomeres, centrosomes, karukensis, or nuclear divisions, etc. After perusing works dealing with the germ-cell, and the initial processes by which the *somma* or body is formed, the ideas of the older breeders seem crude; and how far modern breeders are likely to be influenced in the future by scientific investigations as to the laws of heredity, who can say? One thing, however, appears clear, namely, the probably crossed character of all our pure-bred races. The germ-cells of a confessedly composite race cannot be viewed as absolutely pure; and therefore even "pure" black and "pure" white races may, far back in their history, have contracted a bar sinister, which, according to the teaching of heredity, may still be there, and appear in progeny incalculably removed from the contamination.

The foregoing remarks have not been written with a view of explaining the difficulties of the theory of breeding, but merely to call attention to them. The old breeders were absolutely innocent of them, and worked upon the external appearance of the parents. To them a symmetrically shaped bull, of beautiful touch and quality, was a suitable animal for breeding purposes; and by selecting females on similar lines a more or less faultless race was built up. This is how Bakewell and Colling, the Ellmans, and Bates went to work. They knew nothing of germ-cells, but relied on the principle that "like begets like", unmindful of the equally true fact that like sometimes begets unlike. They were, however, aware of the importance of lineage, which is a guarantee of purity in the germ-cells, and they worked on the double line of personal excellence and descent. They also found that deficiency and redundancy were corrected by exuberance and deficiencies on the other side, and pitted fineness against coarseness. They realized the difficulty of breeding out faults, and the merits of prepotency, especially in bulls. They had faith in pedigree, to such an extent as to give enormous sums for animals of high merit and faultless breeding; and would not use any sire, however perfect in himself, if his breeding was not guaranteed. Hence arose the herd-book, as previously had the stud-book. They were not afraid of close interbreeding, provided the parents were both free from disease and of good form; and many of the sires and

dams of the early breeders were extraordinarily closely bred, being almost entirely composed of Favourite or other famous strains.

This, almost slavish, adherence to paper pedigree was followed by serious evils, for it became the fashion to breed exclusively in one line of blood, and the least deviation from an approved strain at once depreciated a young animal in the sale ring, whatever its appearance. Similarly, unsightly and defective animals were often sold at high prices on the strength of their pedigrees. This policy was not entirely at variance with the theories of modern authorities on heredity, as it apparently showed a strong belief in the absolute fixity of the germ-cell. It, however, resulted in a loss of constitution, and what has been called overbreeding; and this suggested the advisability of crossing with allied strains, of a somewhat different history and origin.

The Scottish Shorthorn breeders discarded rigid adherence to Booth or Bates, and embarked upon a more enlightened course, which has



FIG. 87.—South Devon Cow.

proved eminently successful. Grading up ordinary herds by alliances with successive pure-bred sires became general, especially in America, and short pedigrees of four or five crosses came into greater favour. Still, it must be allowed that long lineage sires are still considered essential, and bull-breeding stands upon a different footing to cow-breeding for milk or beef. It is extremely difficult to build up a herd from ordinary materials that will ever be fit for producing sires; and hence the most successful graders of stock still repair for bulls to established pure-bred herds of long standing, as well as for replenishing their females.

These canons of breeding apply with equal force to all domesticated animals, and are explained at some length under cattle, in order to avoid the necessity of repetition.

A ram-breeder is as particular in the purchase of sires as a bull-breeder ; and it is just as impossible to breed reliable rams from a flock of mixed origin, as reliable bulls from cows of mixed origin. On the other hand, a man whose sole object is to raise a milking herd, or good steers, or, in the case of sheep, heavy fleeces and quick fattening carcasses, can do so on a foundation boasting a shorter history. It is curious to notice how steers and wether sheep may exhibit great excellence in every respect, and yet if the owner relies on these merits, and begins to save his male calves and lambs for breeding purposes, they are almost sure to develop coarseness and want of colour or coat as they approach maturity.

Any one who wishes to enter upon a career as a breeder in the highest sense, must begin with pure-bred females, as well as pure-bred males, and the same is true of all stock. We have known many attempts to graft pure blood upon impurely-bred stock, but the

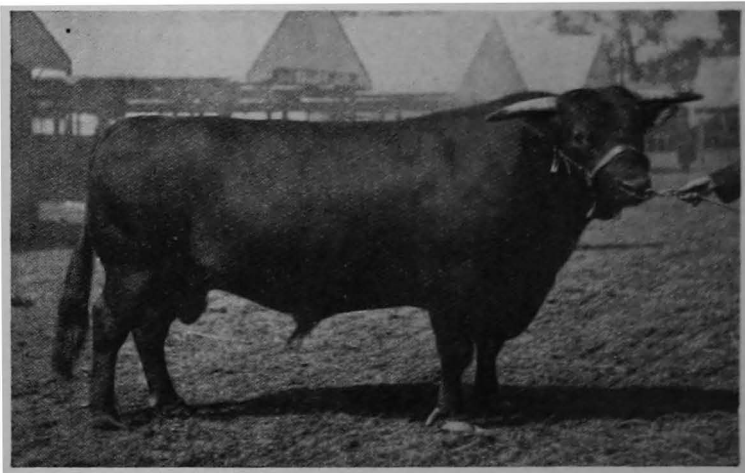

FIG. 88.—Welsh Bull.

results are only successful so far as the production of milk, beef, mutton, and wool, are concerned. It does not apparently touch the germ-cells, or not sufficiently, and the mature male exhibits the ancestral faults.

Grading up is therefore utilitarian in its objects, and from this point of view is entirely successful ; but those who have tried it as a means of producing sires have often found it necessary to dispose of their flocks or herds and start afresh upon the double-barrelled principle of pure-bred animals on both sides.

Ordinary Breeding of Cattle involves a greater or less degree of selection, mostly confined to the bulls. A good male animal has always been considered a desideratum, but a large herd is a bar to careful mating, especially when the practice obtains of keeping one bull for forty or fifty cows. Young bulls are preferred by ordinary

breeders on account of their greater activity and lightness, and the consequence is the purchase of a new bull every year, irrespective of the precise lineage of the previous sire in service.

The race may be the same, i.e. Shorthorn or Hereford, etc., but the estimation of the sire is chiefly measured by his fruitfulness, the object being to get the cows in calf by a fairly good bull. The carelessness of ordinary breeders as to the class of bull used is only too general, although there are many exceptions. The main object is milk, and barrenness is to be kept down to the minimum. This is not systematic breeding, but mere procreation, and results in the propagation of inferior stock. It is neither pedigree breeding nor grading, and is associated with indiscriminate buying of cows of no particular race, but only for milk.

The exceptions are, however, very numerous, and in many parts of the country breeding is carried on with much intelligence, although it may be without keeping an accurate record of pedigrees.

Thus the unpedigreed Shorthorns of the North of England have achieved a very considerable reputation, and form an excellent basis upon which to found a herd. They are, so to speak, pedigreed without knowing it, but bear the impress of pure blood in their forms and coats.

**Age of Heifers for Breeding.**—The modern tendency is to breed from heifers at 2 to 2½ years old, which involves mating them nine months earlier. Fifteen months seems at first sight too young for mating, and no doubt is so in most cases. Still, the practice has been in force for many years in the best herds, as can be seen by inspecting the records of herd-books and of sale catalogues. If heifers are to produce calves at 2 years old, they ought to be well kept from birth. The older practice was for heifers to calve at 3 years old, and this was more in accordance with parsimonious methods of wintering stock.

**Systems of Breeding.**—Breeding is often associated with dairying, for calves and milk are inseparably connected. The tendency is too often to get rid of the calves as soon as possible, in order to obtain the milk. Calves grow into young stock which necessarily occupy land that might carry cows in full profit, and this is objected to by milk-sellers. They therefore prefer to sell their calves as soon as possible, and these are purchased by a different class, who make a point of rearing heifers and bringing them out as down-calvers. By this system the calves may be repurchased two years later by the same men who sold them as calves, and breeding and rearing have thus become separated—probably with mutual advantage.

It may pay the dairy farmer only to keep cows in milk; and it is certain that rearing calves and bringing out a good class of heifers on the eve of calving is a profitable industry. Well-bred heifer calves always command a good price on the market, and good down-calvers are always at a premium.

Another system prevails on hill or mountain pastures where Galloway or West Highland cattle are bred on an extensive scale. The heifers are turned out with a bull, and suckle their calves out of doors. The system is natural, and the effect is to produce cows which yield comparatively little milk. It is probably accountable

for the lower milking properties of Galloway cows, in comparison with the hand-milked Ayrshires.

Systems in which breeding and dairying are carried on together are characteristic of pedigree herds, and also of other herds which are being improved or graded up with a special object. It is only by such systems that real improvement can be effected in this country.

**Management of a Herd.**—Knowledge of cattle is a sort of instinct, not to be acquired by a few months' study. It runs in families, and is difficult to impart to those who have not been brought up in the country. It requires a genuine love of cattle, a keen sense of proportion or form, a good judgment, a retentive memory, and great deliberation. It also needs patience and capital. Great judges of cattle are to some extent artists, and the most eminent breeders have aimed at perfection rather than profit. They possess the artistic

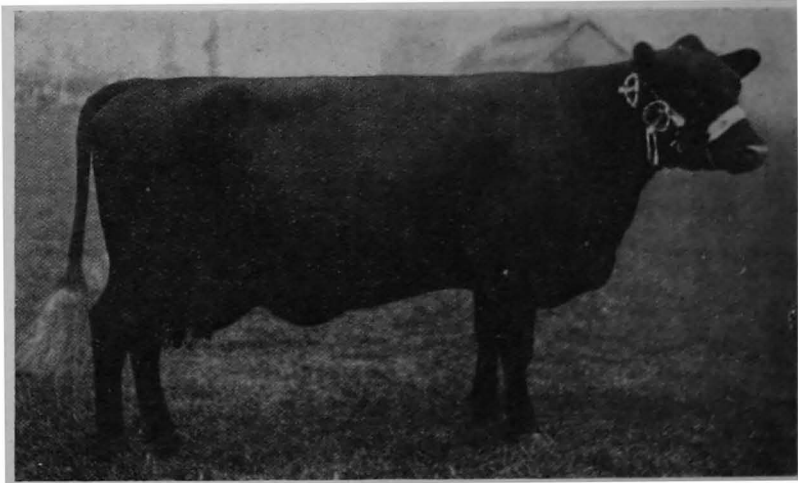

FIG. 89.—Red Poll Cow.

temperament, being contemplative, and often positive in their opinions.

The herd of such a man is bound to improve, and when the details of his management are inquired into they are found to be extremely difficult of explanation. The cardinal point is to have nothing to do with inferior animals, and to select successive sires so as to continue the pedigree with the utmost care as to line. They are not chosen entirely for their external appearance, but so that the names and herd-book numbers which constitute their lineage shall stand criticism and research. The sire in service must harmonize in his breeding with his predecessors, and not introduce a discordant link, and this is the secret of the high prices given for bulls of fashionable strain. A good bull may be purchased for a moderate price, but *the* animal which is able to perpetuate the herd, without any disparagement, may not be obtainable without a considerable

outlay. The higher a herd rises in public estimation, the more essential is it that the sires used should be up to the mark in merit, and to make no mistake on this point is the principal point in successful pedigree breeding.

So far as the general management of the herd is concerned inquirers are often struck with its ordinary character. The buildings are of small importance, so long as they are comfortable, and a thatched roof and wooden partitions may house animals worth large sums of money. It is the same with the daily management, for the cows go out to pasture and come in to be milked, like ordinary cattle. They are not pampered, and may be allowed to remain out most of the winter. The best cattle are strong in constitution, and it is a mistake to think that pedigree cattle necessarily require choicer food or more elaborate surroundings than other descriptions of stock. If they do, one main object of breeding has been sacrificed, which is constitution, and an ability to convert food into marketable products.

The care devoted to pedigree stock arises from their high individual value, and not from any inherent weakness or want of robustness. They must be guarded against all the casualties to which cattle are liable, such as fire, contagion, abortion, strains, hove, and accidents. They require to be well looked after, and should only be entrusted to the care of a first-rate herdsman. These are all points of ordinary management of cattle, and are only more necessary in the case of valuable stock because of their higher individual value.

Keeping up the records of age, parentage, etc., occupies a good deal of time, and in order to prevent mistakes a system of ear-marking or branding must be employed, so that there shall be no doubt as to the identity of any member of the herd. It is therefore evident that the manager of a herd must be gifted with great qualities of observation and alertness, although the animals themselves live a simple life, without being in the least aware that they are the objects of unusual solicitude.

The principal object of Pedigree Stock is no doubt bull-breeding, for cows and heifers are the mothers of bulls; and their excellence is necessary for the transmission of faultless lineage and character to their offspring. Lower grades of breeders may not aspire to be bull-breeders (they are rather bull-buyers), and their efforts are concentrated upon improving the females of their herds. Their object may be milk, or the breeding of high-class steers, but they seldom save calves for bulls.

**Why Milking Properties have been sacrificed.**—The early breeders paid too much attention to beef, and neglected milk production. The reason for this error appears to have been a tendency on the part of high-bred stock to develop flesh rather than milking properties. The symmetry of beef production is different from that which betokens milk. It is massive, square, and the carcass is covered with a deep and mossy coat. The milking type is more rugged, less fleshy, narrower, and inclined to be light in the forequarters. It is less attractive to the high-class breeder, and may be associated with faulty pedigree. The above characteristic symmetry is noticeable



in several noted beef-producing races, such as Shorthorns, Herefords, Devons, Sussex, and Polled Angus, and in all of these the beef-producing type prevails.

**Pedigree Milking Cattle.**—While beef has taken the lead in certain breeds of cattle, others have been bred principally for dairy purposes. We have now distinct races of Lincoln Red and Dairy Shorthorns, in which the original high milking properties of the Yorkshire and Durham Shorthorns have been revived. There are also races dedicated to milk, among which may be mentioned the Ayrshire, Jersey, Guernsey, Norfolk Red-Polls (for both purposes), South Devons, and Kerries. These cattle are of a different type to the beef-producers, the Ayrshire being described as wedge-shaped on account of its narrowness over the withers, its shallowness at the shoulders, compared with its depth at the flanks; and its narrow rumps,

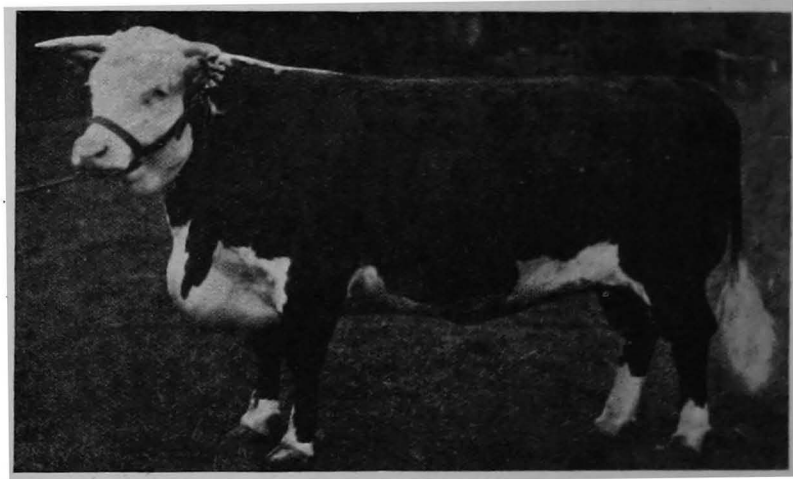

FIG. 90.—Hereford Heifer.

compared with its wide pelvis. This is the type of the milker, and it is often associated with a smoothness of coat and a hardness of skin, not found in Shorthorns and other beef-producing cattle.

**The Treatment of Dry Cows.**—Milking cows should always be either in calf or yielding milk. In ordinary practice they are milked for nine or ten months, and then let off dry for from two to three months, and produce a calf every year, in which case they are called regular breeders.

A barrenner is a cow which has ceased to breed, and she is then fattened, and such cows will maintain their yield of milk longer than those which are in calf. Some heavy milkers will milk through, from calving to calving, but a period of rest is to be recommended. Dry cows should be separated from the milking herd, for three reasons. First, they are in all respects better upon poor keep, such as inferior

pastures or straw-yards, although a cow approaching calving ought not to be reduced to a weak condition. She is relieved from the tax of yielding milk, and will maintain her condition on coarse herbage or straw. Secondly, the expense is less, and it so happens that less costly food tends to safety during parturition. Thirdly, dry cows are quieter, and are less liable to rough treatment from other cows when kept apart, for in-calvers are naturally sedate and restful, whereas newly calved cows are greedy, restless, playful, and often quarrelsome.

In summer dry cows are placed on rushy or rough pastures, and in winter on straw and water, with a little help if thought necessary, in the forms of roots, hay, or cotton cake. They are visited twice daily in winter, and kept under observation in summer, and on the appearance of signs of calving are brought home, or allowed to calve in the field. After calving cows should be approached with caution, by their own herdsmen, and not by strangers.

**Parturition, or Calving.**—Cows frequently calve without assistance, but it is desirable that someone should be in attendance. The chief danger is the loss of the calf, as it might be smothered by the membrane in which its head and nostrils are enveloped, and this often needs to be removed. A calf may even fall, and dislocate its neck, or be found dead with its head doubled under its neck. The immediate signs of parturition are the slacking of the pelvic bones on each side of the tail-head, relaxation of the vulva, and distension of the udder. Uneasiness and recurring pains are the precursors of the appearance of the "water", or membrane in which the head of the foetus may be dimly seen.

The position of the calf may be described as with head resting upon its fore-limbs or pasterns, and if the feet appear with their soles upwards it indicates a breach presentation. In these circumstances delivery may be effected without interference, but false presentations may take many forms. The fore-legs may be doubled, so as to expose the calf to the risk of strangulation; the hocks may be doubled; the head may rest on the side, instead of on the fore-legs; the foetus may be on its back, or be presented broadside, or in several other abnormal positions; or in the case of twins, they may be mixed up, so that the feet of one appear followed by the head of the other. In all such cases assistance is required, and, it may be, veterinary aid, but an experienced herdsman is usually competent to manage ordinary calving.

The cow ought to be sparingly fed before calving, and in the language of an eminent veterinarian, should be as "empty" as possible. A full rumen is to be avoided, as it only causes distress to the cow; and a warm bran mash should be given immediately after the calf is born, and the cow should also be at once milked, and made comfortable.

**Newly Born Calves.**—The ordinary practice in the South of England is to allow calves to suck, but in the thrifty North they are removed without a moment's delay, and rubbed dry in a hutch or crib. As to the merits of these two methods of treatment, the arguments are in favour of the less natural system, except in special

cases. Calves may be allowed to receive their nourishment in Nature's own way under the following circumstances :—

1. In the case of a heifer's first calf, when the teats are short, and the udder requires to be softened, or what is called "broken".
2. In the case of calves intended for keeping as bulls.
3. Sometimes in the case of veal-calves.

Calves intended for weaning and rearing, are better brought up by hand ; but so strong is custom that it is difficult to convince those who have been accustomed to the rival system. The objections to it are, however, very cogent, for in the first place it makes it somewhat difficult to control the quantity of milk which a calf receives. Secondly new milk is an expensive diet, if continued, and it is impossible to introduce milk substitutes or skim milk unless the calf

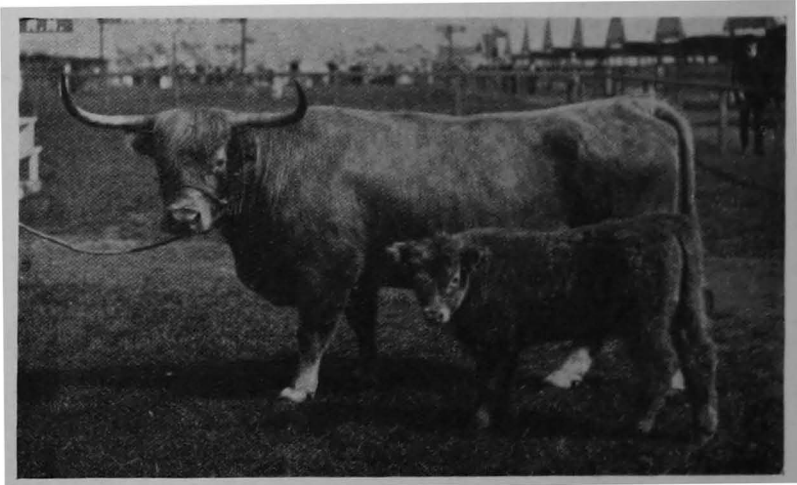

FIG. 91.—Highland Cow and Calf.

has been taught to drink from a bucket. Cows which nurse their calves are liable to be uneasy all day till they return to them, as is seen in the way they hang about gateways, or hurry along the road home. The custom is to milk first, and let the calf have what is left in the udder, but this is open to the objections that too much or too little may be left back, and that in the one case the cow will not be perfectly stripped, and in the other the calf may remain short of food.

**Teaching Calves to Drink.**—Calves are easily taught to drink if they are begun early. They naturally suck anything presented to them, and seize the fingers of their attendant, especially if dipped in milk. This instinct is taken advantage of, and the lips of the calf are lowered into warm milk while sucking the fingers, and the consequence is a flow of the fluid into its mouth. The fingers after

a few lessons may be withdrawn, and the calf has then learned to drink.

Calves are naturally disposed to "dunch" or throw up their heads in order to stimulate the natural flow of milk from the udder, and this may upset the bucket, so that it must be held while the calf drinks. The amount given the first day is about 1 pint every four or five hours, and during the first week it is fed three times a day—

2nd day,	1 quart in the morning,	1 quart at noon,	1½ quarts at night.
3rd day,	1½ " " "	1½ " " "	2 " "
4th and 5th,	2 " " "	1 " " "	2 " "
6th and 7th,	2½ " " "	1 " " "	2½ " "
8th and 9th,	3 " " "	0 " " "	3 " "
10th day to end of the first month—			
	4 quarts in the morning,	0 " " "	4 " "
2nd month,	4 " (old milk) "	0 " " "	4 " (old milk) "
3rd month	4 " " "	0 " " "	4 " " "

This dietary assumes that the calf will be learning to eat a little sweet meadow hay as well as finely ground linseed cake and meal. They are taught to eat by placing a little of these dry foods in their mouths, and when they realize the flavour they will be induced to try a little more. Old milk may be enriched with calf meals or milk substitutes, such as are now supplied at moderate cost. This system is very much less expensive than a new milk diet, and even skim milk is not always available if contracts are to be kept up. Hot water is recommended for mixing foods, and the directions for making the gruel should be carefully observed. Perhaps no food is quite equal to new milk, and this is the opinion of many herdsmen who bring up bull and veal calves, but, for animals intended for rearing, for grazing, or for the dairy, milk substitutes are extremely useful.

**Best times of year for Calving.**—Cows naturally calve in spring, as do all ruminants. In running dairies, it is desirable that they should come in throughout the entire year, and when this cannot be accomplished cow-keepers frequent markets and purchase down-calvers and newly-calved cows. These are always at a premium in August, September, and October, and in most herds calving becomes commoner in November and December, and general in January. There is in fact often a glut of milk in April, which suggests keeping back calves to drink the surplus supply.

So far as calves are concerned, they do best when born before Christmas, as they are then strong for turning out in May or June; but March- and April-born calves are better kept in during their first summer, and fed on green food. Very young calves are susceptible to cold nights and fogs, and only do well out of doors for a few weeks. In September they are liable to contract coughs, and they ought to be housed before Michaelmas. This indicates the broad lines of management, and it is of importance that calves should not go back in condition during their first summer. They should always have a hovel or shed for both hot days and cold nights, and are all the better for 1 lb. per head per day of linseed cake. They should not, however, be "over-caked", but eat up all that is supplied to them. Neither

should they receive any fibrous or indigestible feeding-stuffs before their digestive organs (Fig. 92) are capable of assimilating such food.

**Calves during their First Winter.**—Stirks or weanlings should be well kept during their first winter. They are placed in a well-shedded yard or covered shed, and receive about 1 lb. of linseed cake and 1 lb. of meal, sliced swedes, and hay, with a supply of good water. They are then from 9 to 15 months old, and may be better divided into two lots, according to their size. They require to be well attended to, regularly fed, and well bedded, and will then come out in good condition, and carry good coats.

**Yearlings.**—Cattle are considered calves till they are 1 year old, and are yearlings till they are 2, and so on. This is the show-yard rule, and shows the importance of early calving for animals intended for exhibition. Yearlings are much stronger than calves, and may be turned out on to distant pastures, and require but little supervision. Heifers may run with a young bull, if intended to come into the herd or "dairy". They may remain out till severe weather sets in, and this may not be till December or January. They act a useful part in clearing up pastures after cows and fattening bullocks have done with

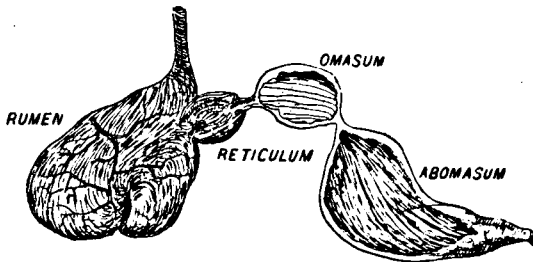

FIG. 92.—Stomachs of the Ox.

them, and are therefore fit subjects for winter grazing. They are brought into yards when the grass is exhausted, and are then approaching 2 years old.

**Winter Management of 2-year-old Heifers.**—According to ordinary management, heifers may now be in-calvers, and ready for sale early in the year. They never look better than when off grass, but steers may be wintered in straw-yards with 2 to 4 lb. of cotton cake and a few swedes or mangel-wurzel. In some cases they have hay, but when this is the case cake may be dispensed with. Much depends upon the class of land which is to carry them during summer, and the intention of their owners as to fattening.

**The Summer Management of 2-year-old Steers** consists in grazing—it may be on rough ground, or in plantations, and they need no extra food as long as grass is plentiful. At 2½ years old they are either sold to winter graziers, or fattened at home. Their value depends a great deal upon their condition; for "fresh" or "forward" steers only require a few weeks of hard feeding to make them fat.

**Fattening Cattle.**—Fattening may be from birth, or begun at a riper age. Many good graziers prefer 3 year old, or even older, steers, but early maturity is now the aim with both breeders and feeders. If cattle are fattened from birth, a different system is pursued, in order that they may be ready for slaughter at 15 or 18 months old. This method is often associated with suckling the calf, and both mother and offspring are liberally treated, and sold together as fit for killing. There is much to commend the system, but it is exceptional rather than general. The usual plan is to buy  $2\frac{1}{2}$ -year-old steers, and gradually bring them on to winter food. They are first put on grass, and receive turnips carted out to them, and are brought into yards in October or November.

**General Management of Fattening Cattle.**—All graziers agree that the fattening process should be as rapid as possible. They prefer to begin upon animals in forward condition, in order to finish them off in



FIG. 98.—Galloway Bull.

a few weeks. Half-fat bullocks can often be purchased at low prices, as they fail to attract the butchers, and the grazier not only obtains the advantage of their increase in weight, but also a higher price per stone. Poor bullocks are bought at considerably less money, but take more time, and move very slowly at first. This is because they first lay on inside fat, i.e. accumulate fat around the kidneys (suet) and intestines (tallow) before they begin to put on "flesh". The fact is that fattening has but little to do with flesh or muscle, but consists in increasing the adipose tissue or fat. Growing animals develop muscle as well as bone, hide, and all other "offal" parts of the body, and this makes them slower to fatten than mature animals. They, however, increase in value and size, but require the whole of the winter for the purpose. Young steers, put up to fatten early in November, will scarcely be fit for market

before the following April, or in about twenty-two weeks, whereas forward or half-fat bullocks may come out at Christmas, and leave room for a second lot, to be brought out at the close of the season.

Feeding should be progressive, and the increase of food gradual, or the result will be that the animals become surfeited. During the first fortnight they get accustomed to their new surroundings and confinement, especially if tied up, and for some days they miss the grass, and the freedom of the pastures. They have to become accustomed to chaff and manger feeding, and to know their feeder and their neighbours. The allowances of cake and meal will be comparatively small at first, but may be increased every fortnight, until a maximum is arrived at, as shown in the subjoined schedule. They must, however, be kept contented by having a constant supply of hay, oat straw, or other fodder within reach, and a good source

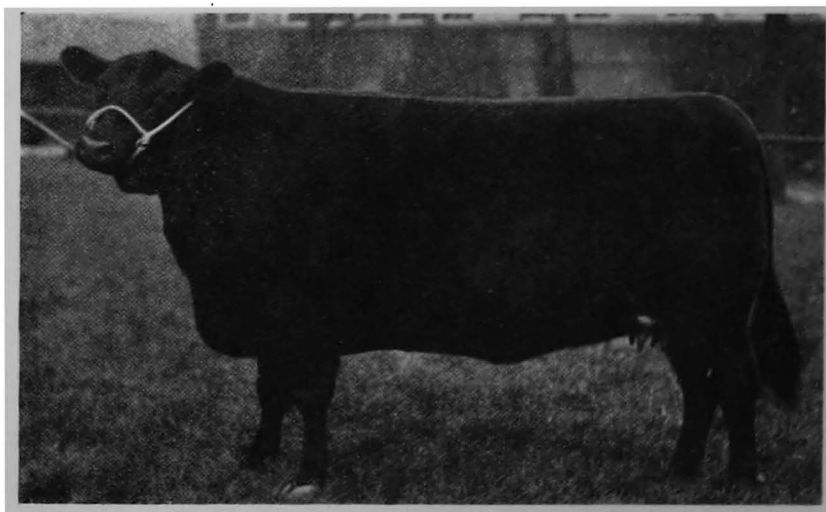

FIG. 94.—Aberdeen Angus Cow.

of clean and pure water. Some kind of food must always be supplied *ad libitum*, and limitations are confined to the concentrated foods.

When tied up, cattle require grooming to keep their skins clean and their coats blooming. This may be done with a stiff brush dipped in a bucket of water, and a curry-comb, and the attention will be amply repaid. These cattle are never freed, and are often in semi-darkness. They are debarred from licking themselves like cattle in loose-boxes; or from standing out in the rain like those in yards. Stalled cattle are liable to become dirty, lame, and purblind; and when finally freed from confinement they are often half mad with excitement. The system is scarcely to be recommended, but has an advantage in economy of space—about the only one. When this system is used, grooming should certainly be practised, and the buttocks especially should be kept free from filth, by daily washing and plenty of clean litter.

Regularity in feeding is of great importance, for a neglectful feeder will never get his cattle fat. The mangers must be kept well brushed out, and the residues of previous meals cleared away. The best rule is to feed little and often, and to prevent the animal from becoming surfeited.

**Schedule of Feeding Cattle at different stages.**—The following schedule is not intended to be rigidly followed, but applies to 2-year-old cattle intended for sale at under 3 years old :—

1st fortnight, Nov.	4 - Nov.	18, 2 lb. cake, 2 lb. meal.
2nd	19 - Dec.	3, 3 lb. ,, 3 lb. ,,
3rd	Dec. 4 - ,,	18, 4 lb. ,, 4 lb. ,,
4th	19 - Jan.	2, 5 lb. ,, 5 lb. ,,
5th	Jan. 3 - ,,	17, 5 lb. ,, 6 lb. ,,
6th	18 - Feb.	2, 6 lb. ,, 6 lb. ,,
7th	Feb. 3 - ,,	18, 6 lb. ,, 7 lb. ,,
8th	19 - Mar.	4, 7 lb. ,, 7 lb. ,,
9th	Mar. 5 - ,,	19, 7 lb. ,, 8 lb. ,,
10th	20 - Apr.	3, 8 lb. ,, 8 lb. ,,

Roots, chaff, and fodder, as see below.

The amount of roots supplied varies with the locality, for in Scotland they are given *ad libitum*, and constitute the principal item of the dietary, while cake and meal are supplied in only half the above quantities. The swedes grown in the North are of better quality, and the crops are much heavier than in the South, and the result is that feeding in the North and South differs materially with regard to roots. It is by no means easy to say what weight of roots bullocks would eat, if fed exclusively upon them, but they will consume one-quarter of their live weight of grass daily. It is well known that a bullock will have no difficulty in disposing of 2 cwt. of roots per day, and they often are allowed it.

Roots are both meat and drink, for when they are liberally supplied neither cattle nor sheep need water. According to approved published dietaries from 28 to 56 lb. of roots are thought sufficient for fattening cattle, and examples might be given of their having been fattened on maize, linseed cake, and wheat straw, without roots. Roots must, however, be considered as a cheap, nutritious, and palatable food, not to be given in too great quantities in cold weather, when the temperature is below freezing-point. They are better pulped and mixed with straw chaff and meal, and a feed of sliced swedes given alone makes a pleasant change, and may relieve thirst after a meal of meal and chaff.

**Frequency of Meals.**—A good feeder begins with meal and cake, mixed with hay chaff, not later than 5.30 a.m. At 7.30 to 8 he may give his cattle 20 lb. of sliced swedes, and at 9.30 meal, chaff, and pulped roots. At noon they may have a feed of cake alone, and at 2, and again at 4, meal and chaff with pulped roots as before. At 6 to 8 at night the racks should be supplied with hay or oat straw, and this concludes the day's routine. According to these directions the cattle will be fed seven times a day, and if this be thought too often two meals may be rolled into one, so as to reduce the number of feeds to four or five. Water should be accessible at all times.



**Increase in Weight.**—Under ordinary store conditions cattle increase in weight at the rate of about 1 lb. per day, but when put up to fatten they will put on from 2 to 3 lb. A more correct statement would be in terms of per 1,000 lb. of live weight, and ordinary steers will begin the fattening process when from 1,000 to 1,300 lb. weight and increase at the rate of from 1.6 to 2.8 lb. per head (these are actual cases) during the whole period. A weigh-bridge is a useful adjunct to a farm, and after cattle have been coaxed on to it three or four times they readily walk on of themselves.

**Importance of making Cattle Prime Fat.**—Half, or badly fattened cattle never sell well, and hence the last month's feeding often pays better than any part of the preceding period. This is in some respect inconsistent with weighing results, as cattle put on weight most quickly in the early stages. The first increase, however, is chiefly internal, and not so evident to the eye and touch; and it

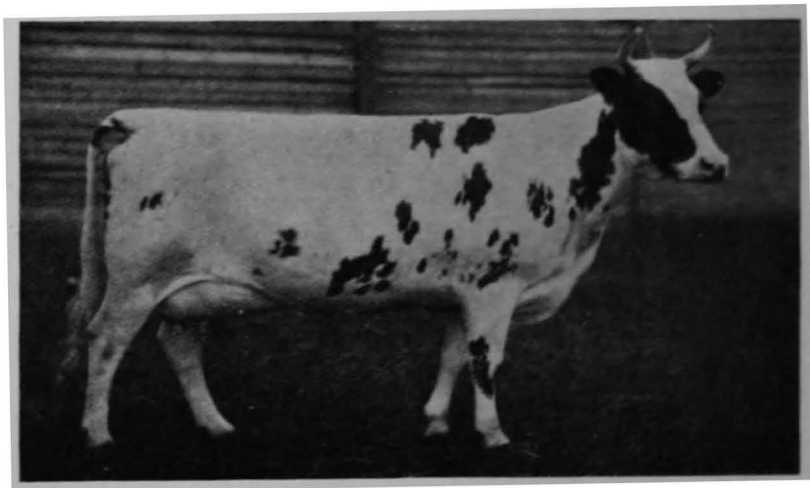

FIG. 95.—Ayrshire Cow.

is during the final weeks that cattle assume a thoroughly well-grazed appearance, and command the attention of butchers. A slight gain in price per stone on account of quality, say of 2d. per 8 lb., makes a considerable difference in the price of a bullock, and buyers are keen to secure well-finished cattle. On the other hand, old cows scarcely pay for a long keep, and are better sold as soon as they can be called "beef".

**Merits of different Foods.**—It would carry us beyond our limits to discuss the merits of different feeding-stuffs. The subjects of albuminoid ratios, starch equivalents, and food coefficients are highly complicated, and in some cases the foods mutually interfere with each other's action. Practical graziers have solved these problems with wonderful success, and a well-trained herdsman will bring out exhibition cattle of perfect form, and in the pink of condition. They

mostly rely on simple foods of the best quality, such as hay, linseed cake, and meal, and are not averse to condiments or special foods, in moderate quantities. As to the relative merits of the various cakes, linseed is preferred, but mixtures of linseed and decorticated cotton cake are in general use. So also are saccharine substances such as treacle, molassine, and molascuit, and also cod-liver oil, linseed mucilage, locust beans, etc.

The variety of feeding materials offered is now very great, and most of them have merits. A practical grazier watches the market, and notes the fluctuation in prices, which sometimes favour one description of food and sometimes another. A mixture of foods is also on the whole advantageous, and the manurial residues are to be taken into account. It is difficult to advise as to the purchase of foods, except to impress the importance of albuminoids, oil, starch, sugar, digestible cellulose, and mucilage. These are spoken of as nitrogenous

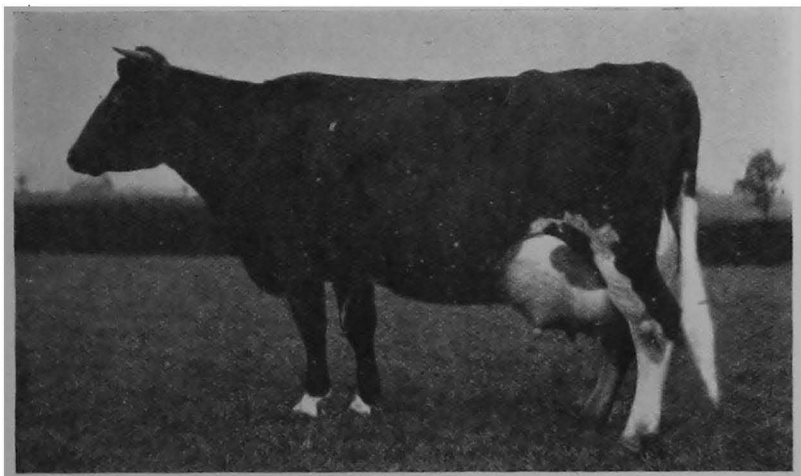

FIG. 96.—Holstein Cow.

and carbonaceous, and the ratio between them is known as the albuminoid ratio.

In young animals and milking cows this ratio should be high, i.e. from 1 : 5 to 1 : 6, whereas in mature oxen it need not be more than 1 : 10 or 1 : 12. As, however, in this country fattening cattle are generally young, an albuminoid ratio of 1 : 8 is recommended. A typically apportioned dietary worked out by Professor Berry of the West of Scotland Agricultural College gives an albuminoid ratio of 1 : 6.3 in a ration of 42 lb. swedes, 7 lb. of hay, 14 lb. of oat straw, 4 lb. of crushed oats, and 4½ lb. of decorticated cotton cake. The diet is evidently taken from ordinary practice, the albuminoid ratio being deduced, and it does not appear to be scientifically compounded but rather of an ordinary one, such as would be approved of by almost any practical farmer. There is comfort in this reflection to

young scientific farmers, as there is also in a dictum of the late Sir John Lawes in which he wrote, "If I were asked to state in general terms what was the approximate proportion of the nitrogenous to the non-nitrogenous substances, below which they should not exist in the food of our stock, I should say (though with reservations) about such as we find them in the cereal grains." On the other hand, colostrum or first milk, the first food of a young calf, has an albuminoid ratio of 2 : 1—clover hay 1 : 3 and beans 1 : 1.8.

The calculation of albuminoid ratios is not an easy task, on account of the varying conditions in which the nitrogenous and non-nitrogenous nutrient constituents exist, and before a reliable conclusion can be arrived at an expert's advice is necessary. What may appear in an analysis as albuminoids may be largely composed of amides or immature nitrogenous matter ; and what appear as fats may be partly composed of wax.

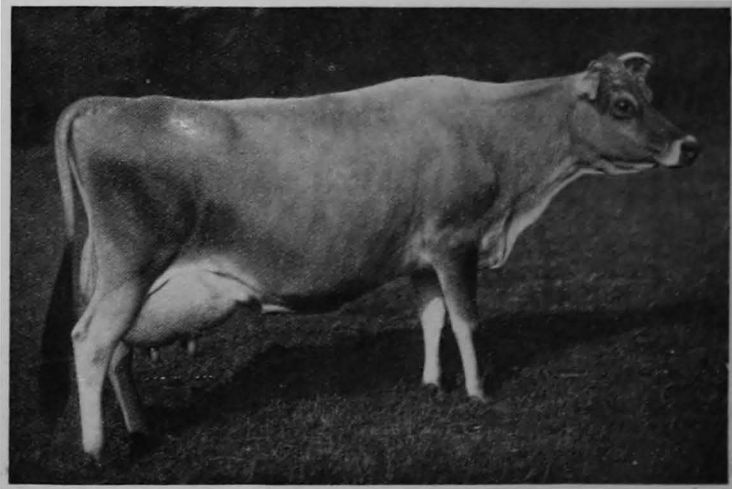

FIG. 97.—Jersey Cow.

**Cow-keeping for Small-holders.**—Before closing this short account of cattle and their management a few remarks may be acceptable upon the cottager's cow, a feature in peasant life which has been sung by poets, limned by artists, extolled by politicians, and dreamt of by land reformers. She is personified as of somewhat mongrel type, brindled in colour, crumpled in horns, ragged in hips, and socially solitary. She grazes on the common during the day, and reposes on bracken at night, under a thatched roof. She is sometimes a good milker, but that is the point to which particular attention is now to be directed, as is also her management. We wish, in fact, to see a reformed cottager's cow, kept upon an improved principle, and more capable of feeding a family. She is not necessarily to be solitary or to browse with a nondescript lot of other cows on the confines of the forest, or in green lanes ; but is to form a part of the stock of the small-holder.

As to breed, she may yet remain a half-bred Jersey, a Norman, or forest-bred, but she must be a milker, hardy, frugal, and thrifty. For this purpose Kerrys have been suggested, and Brittany cows, but both are too small to give large quantities of milk. She is on the whole better for not being too highly bred, and we should not expect her to possess a recorded pedigree. Her lineage may be mixed, and her colour may be black and white, red and white, dun or fawn, and her contour irregular, but she must be a prolific milker. It is true that a small-holder may aspire to keeping pure-bred stock, for such men are not necessarily poor. Villa residents may describe themselves as small-holders, and Channel Island cows are great favourites where only one or two are kept. Pure-bred cows are, however, beyond the reach of most small-holders, and we would rather recommend to them the same class of mixed cattle, of excellent milking properties, which many larger dairy farmers swear by.

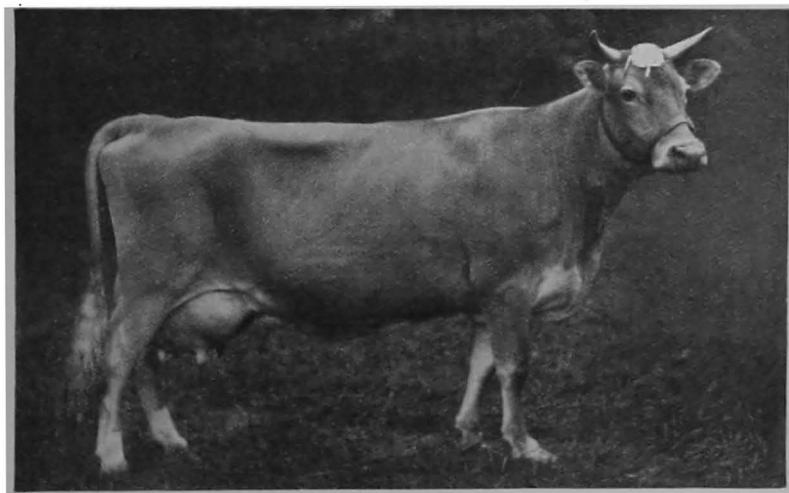

FIG. 98.—Guernsey Cow.

Few cows are more profitable as milkers than half-bred Herefords and Shorthorns, or those with a dash of Dutch blood in their veins. The writer has known a Hereford Shorthorn cow give 7 gallons a day, and there are many small lots of selected cows of no particular breed which would beat the records of more pretentious herds if submitted to the test. The cows are picked up on local markets on account of their character, as opportunity offers, and are often kept for several years after what is considered to be the prime of bovine life. In this connexion, we may be allowed to bestow a word of praise on old cows, without recommending them to purchasers. Cows over 10 years old often beat those under 10 in yield of milk, and a good cow and regular breeder is not only worth keeping, but should not be hurriedly parted with. There is no reason why a small-holder should not wean a few heifer calves from good cows, and thus

As to breed, she may yet remain a half-bred Jersey, a Norman, or forest-bred, but she must be a milker, hardy, frugal, and thrifty. For this purpose Kerrys have been suggested, and Brittany cows, but both are too small to give large quantities of milk. She is on the whole better for not being too highly bred, and we should not expect her to possess a recorded pedigree. Her lineage may be mixed, and her colour may be black and white, red and white, dun or fawn, and her contour irregular, but she must be a prolific milker. It is true that a small-holder may aspire to keeping pure-bred stock, for such men are not necessarily poor. Villa residents may describe themselves as small-holders, and Channel Island cows are great favourites where only one or two are kept. Pure-bred cows are, however, beyond the reach of most small-holders, and we would rather recommend to them the same class of mixed cattle, of excellent milking properties, which many larger dairy farmers swear by.

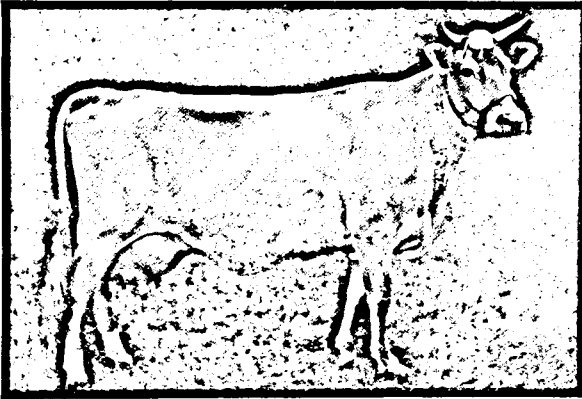

FIG. 98.—Guernsey Cow.

Few cows are more profitable as milkers than half-bred Herefords and Shorthorns, or those with a dash of Dutch blood in their veins. The writer has known a Hereford Shorthorn cow give 7 gallons a day, and there are many small lots of selected cows of no particular breed which would beat the records of more pretentious herds if submitted to the test. The cows are picked up on local markets on account of their character, as opportunity offers, and are often kept for several years after what is considered to be the prime of bovine life. In this connexion, we may be allowed to bestow a word of praise on old cows, without recommending them to purchasers. Cows over 10 years old often beat those under 10 in yield of milk, and a good cow and regular breeder is not only worth keeping, but should not be hurriedly parted with. There is no reason why a small-holder should not wean a few heifer calves from good cows, and thus

perpetuate a good strain. Heifers are easily kept, and come in to take the place of older cows when they cease to breed.

Small-holders are not a new class, and the memory of the writer carries him back sixty or more years to back lanes and rushy pastures, where grazed the few cows of men and women of that class. The small-holder has every inducement to look well after his cows, and to keep them on good food. It is easier for them to give warm mashes, wet grains, bean meal, and mangel-wurzel to two or three cows, and he is more likely to take pains with the feeding, than is a paid dairyman, who has charge of fifty cows, besides breeding pigs, and poultry.

In France, Germany, Belgium, and other countries cows are taught to draw light wagons, and it seems a pity that small-holders in this country do not use their cows in a similar manner. It would probably be for light work, and ought not to be too arduous or long

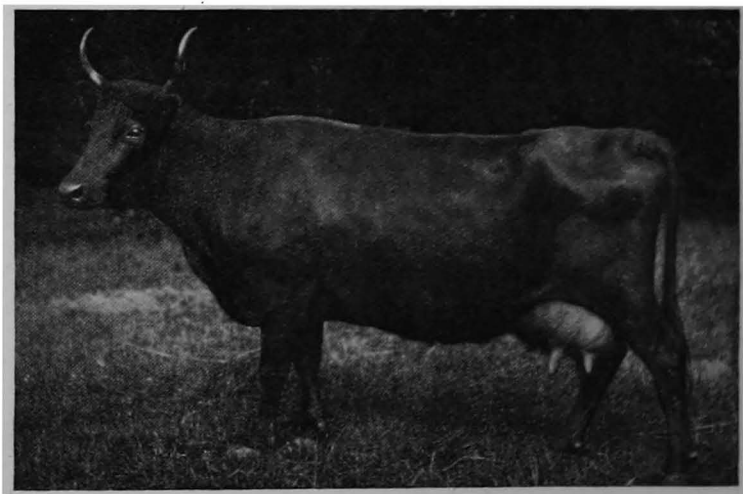

FIG. 99.—Kerry Cow.

continued. The custom is too general throughout the world, and too ancient, to be pooh-poohed as obsolete and impracticable. Besides, it has been shown by direct experiment that a little work enriches the milk, and does not lower its yield. Neither does it seem likely, on the face of it, that exercise and a little work should hurt anybody, as we may say. Recently we have heard of cases in which the system of working cows has been adopted in this country, and the idea ought to be encouraged rather than the opposite. It was not, however, the intention of the writer to give prominence to the idea of working cows, but in thinking of their importance on small holdings, their strength, and capacity for work, and their great docility, which renders them particularly easy to break to harness, it seemed to force itself upon his attention.

The profitable nature of a good cow is worthy of more notice than her value as a draught animal. Her value depends a good

perpetuate a good strain. Heifers are easily kept, and come in to take the place of older cows when they cease to breed.

Small-holders are not a new class, and the memory of the writer carries him back sixty or more years to back lanes and rushy pastures, where grazed the few cows of men and women of that class. The small-holder has every inducement to look well after his cows, and to keep them on good food. It is easier for them to give warm mashes, wet grains, bean meal, and mangel-wurzel to two or three cows, and he is more likely to take pains with the feeding, than is a paid dairyman, who has charge of fifty cows, besides breeding pigs, and poultry.

In France, Germany, Belgium, and other countries cows are taught to draw light wagons, and it seems a pity that small-holders in this country do not use their cows in a similar manner. It would probably be for light work, and ought not to be too arduous or long

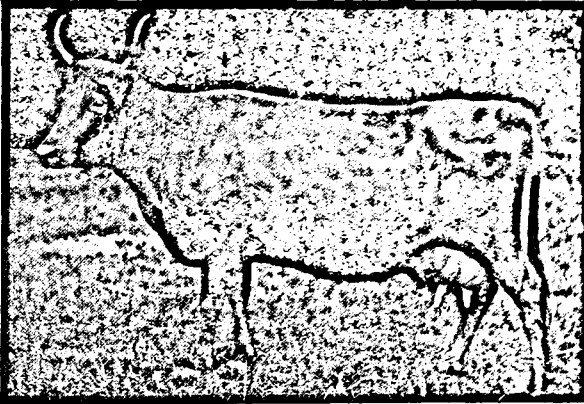

FIG. 99.—Kerry Cow.

continued. The custom is too general throughout the world, and too ancient, to be pooh-poohed as obsolete and impracticable. Besides, it has been shown by direct experiment that a little work enriches the milk, and does not lower its yield. Neither does it seem likely, on the face of it, that exercise and a little work should hurt anybody, as we may say. Recently we have heard of cases in which the system of working cows has been adopted in this country, and the idea ought to be encouraged rather than the opposite. It was not, however, the intention of the writer to give prominence to the idea of working cows, but in thinking of their importance on small holdings, their strength, and capacity for work, and their great docility, which renders them particularly easy to break to harness, it seemed to force itself upon his attention.

The profitable nature of a good cow is worthy of more notice than her value as a draught animal. Her value depends a good

deal upon locality, for where milk is dear the revenue she yields is very considerable. Milk cannot be bought in most places for less than 4*d.* per quart, and a cow of the right sort will produce 3,200 quarts in a year. Even a fair average cow ought to give 2,400 quarts (600 gallons), which at 4*d.* equals £40. A large cow-keeper in Newcastle-on-Tyne informed the writer that every  $\frac{1}{4}$ *d.* per pint yielded a revenue of £5 per head over his entire herd, and this comes to £40 at 4*d.* per quart, on the assumption of an average yield of 600 gallons. These are not extravagant estimates, but contrast favourably with the wholesale price of milk given to farmers. They dispose of their milk at from 5*d.* to 8*d.*, and 9*d.*, per gallon, and the retailer who keeps two or three cows, and can dispose of his produce at 4*d.* per quart enjoys a great advantage over the big farmer.

Cows sometimes yield 1,000 gallons between their calvings, and if this can be realized and valued at 4*d.* per quart or 1*s.* 4*d.* per gallon,

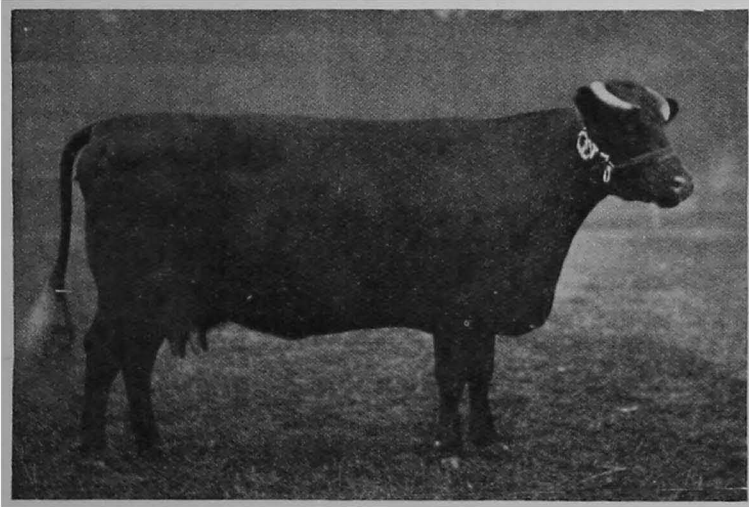

FIG. 100.—Lincoln Red Cow.

the amount per annum would be £66 13*s.* 4*d.* ! It is always a pity to give too sanguine a view of profits, but this would be gross revenue, and does not take account of expenses, risks, and disappointments. The practical way of looking at the subject is, that 600 gallons is not an extravagant estimate over a few well-selected cows, and therefore at 1*d.* per pint, or 8*d.* per gallon, each cow would yield £20 per annum. Such a result would be satisfactory to a large farmer who sells milk winter and summer, but would be doubled by a retail milk-seller. It is difficult to calculate the cost of maintaining cows, and much depends upon the scale adopted for winter feeding. If, however, cows calve in March or April, they will be in full profit through the summer and autumn, or till the end of October, i.e. for nearly seven months. If, therefore, a small-holder can secure a good retail price for his milk during the grazing period he will be able to convert the bulk of his produce into money at a minimum cost of production.



deal upon locality, for where milk is dear the revenue she yields is very considerable. Milk cannot be bought in most places for less than 4*d.* per quart, and a cow of the right sort will produce 3,200 quarts in a year. Even a fair average cow ought to give 2,400 quarts (600 gallons), which at 4*d.* equals £40. A large cow-keeper in Newcastle-on-Tyne informed the writer that every ¼*d.* per pint yielded a revenue of £5 per head over his entire herd, and this comes to £40 at 4*d.* per quart, on the assumption of an average yield of 600 gallons. These are not extravagant estimates, but contrast favourably with the wholesale price of milk given to farmers. They dispose of their milk at from 5*d.* to 8*d.*, and 9*d.*, per gallon, and the retailer who keeps two or three cows, and can dispose of his produce at 4*d.* per quart enjoys a great advantage over the big farmer.

Cows sometimes yield 1,000 gallons between their calvings, and if this can be realized and valued at 4*d.* per quart or 1*s.* 4*d.* per gallon,

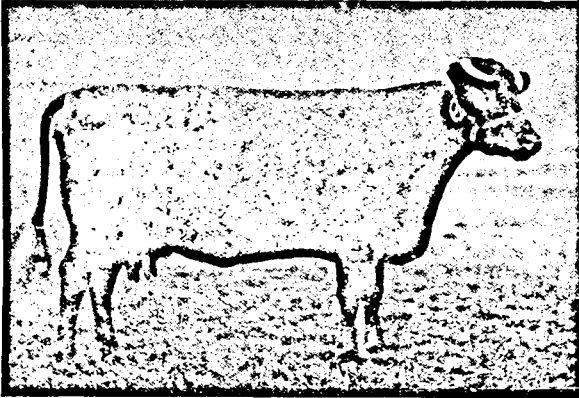

FIG. 100.—Lincoln Red Cow.

the amount per annum would be £66 13*s.* 4*d.* ! It is always a pity to give too sanguine a view of profits, but this would be gross revenue, and does not take account of expenses, risks, and disappointments. The practical way of looking at the subject is, that 600 gallons is not an extravagant estimate over a few well-selected cows, and therefore at 1*d.* per pint, or 8*d.* per gallon, each cow would yield £20 per annum. Such a result would be satisfactory to a large farmer who sells milk winter and summer, but would be doubled by a retail milk-seller. It is difficult to calculate the cost of maintaining cows, and much depends upon the scale adopted for winter feeding. If, however, cows calve in March or April, they will be in full profit through the summer and autumn, or till the end of October, i.e. for nearly seven months. If, therefore, a small-holder can secure a good retail price for his milk during the grazing period he will be able to convert the bulk of his produce into money at a minimum cost of production.

Townspople are not aware of the difference in cost of production between summer and winter milk, and appear to pay very much the same price all the year round, neither do they look upon 4*d.* per quart as exorbitant. To keep a connexion together it is necessary to maintain the supply during the entire year, and this is why a running dairy is important. This also entails winter feeding on a more expensive basis.

The small-holder should therefore study winter feeding. He should set aside a portion of his grass land for mowing, on the assumption of 1 ton of hay per cow. If he gives about 18 to 20 lb. per head per day, 1 cwt. will last six days, and 1 ton 120 days, which may be sufficient. He may also grow corn for straw, or may depend upon fern, rushes, or coarse grass. An acre of good mangel should yield 25 to 30 tons of excellent roots, and if by systematic feeding he can keep the daily allowance of each cow to 30 lb., it is clear that

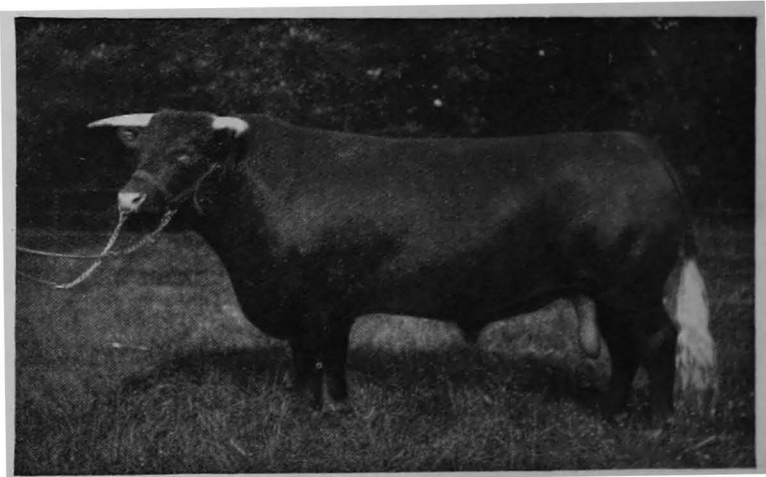

FIG. 101.—Sussex Bull.

1 ton (2,240 lb.) will last a cow seventy-four days, and that 2 tons will almost see her through the winter. Even half an acre of well-cultivated mangel would therefore probably be sufficient for six cows. On a basis of 20 lb. of hay and 30 lb. of mangel-wurzel, the remaining food would be of a supplemental character, and might consist of 4 or 5 lb. of ordinary cotton cake, 1 to 2 lb. of bran, and 1 to 2 of bean meal. This would be good feeding, and would be well paid for, if the milk could be sold at 4*d.*, or even 3*d.* per quart.

**The Dentition of the Ox.**—In the upper jaw of the ox there is a resilient fibrous pad covered by mucous membrane, while in the front of the lower jaw there are eight incisors or cutting-teeth. The age of a dairy-cow, in years, is often approximately ascertained by adding two to the number of rings found at the base of her horn, but for a more accurate and reliable determination the teeth must be examined.

Townpeople are not aware of the difference in cost of production between summer and winter milk, and appear to pay very much the same price all the year round, neither do they look upon 4*d.* per quart as exorbitant. To keep a connexion together it is necessary to maintain the supply during the entire year, and this is why a running dairy is important. This also entails winter feeding on a more expensive basis.

The small-holder should therefore study winter feeding. He should set aside a portion of his grass land for mowing, on the assumption of 1 ton of hay per cow. If he gives about 18 to 20 lb. per head per day, 1 cwt. will last six days, and 1 ton 120 days, which may be sufficient. He may also grow corn for straw, or may depend upon fern, rushes, or coarse grass. An acre of good mangel should yield 25 to 30 tons of excellent roots, and if by systematic feeding he can keep the daily allowance of each cow to 30 lb., it is clear that

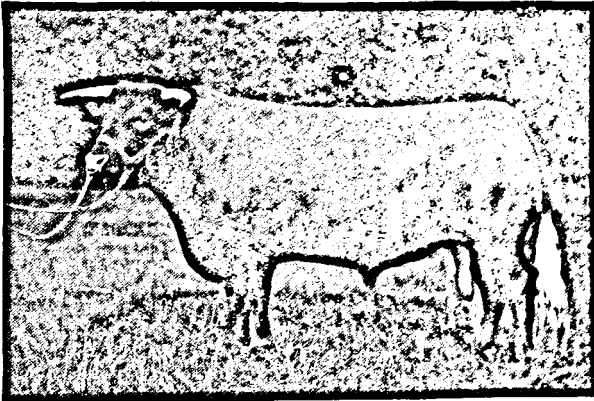

FIG. 101.—Sussex Bull.

1 ton (2,240 lb.) will last a cow seventy-four days, and that 2 tons will almost see her through the winter. Even half an acre of well-cultivated mangel would therefore probably be sufficient for six cows. On a basis of 20 lb. of hay and 30 lb. of mangel-wurzel, the remaining food would be of a supplemental character, and might consist of 4 or 5 lb. of ordinary cotton cake, 1 to 2 lb. of bran, and 1 to 2 of bean meal. This would be good feeding, and would be well paid for, if the milk could be sold at 4*d.*, or even 3*d.* per quart.

**The Dentition of the Ox.**—In the upper jaw of the ox there is a resilient fibrous pad covered by mucous membrane, while in the front of the lower jaw there are eight incisors or cutting-teeth. The age of a dairy-cow, in years, is often approximately ascertained by adding two to the number of rings found at the base of her horn, but for a more accurate and reliable determination the teeth must be examined.

Of temporary molars there are three on either side of both upper and lower jaws, plainly visible at 1 month old, as are also the full set of temporary incisors, while the three additional permanent

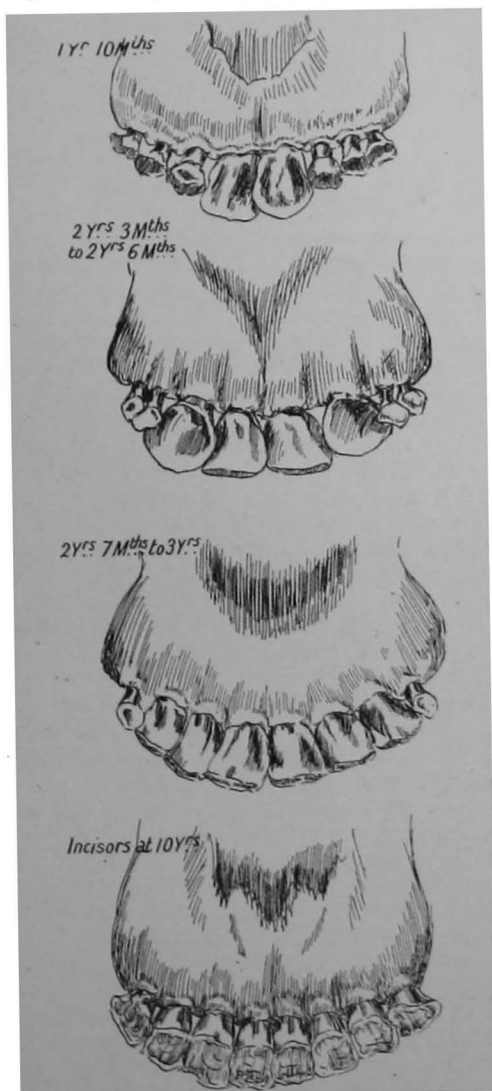

FIG. 102.—Dentition of the Ox.

molars, four, five, and six, in position, are cut at 6, 15, and 24 months respectively; and when the first three temporary molars are replaced by permanent teeth at 2½ years, the full set of molars on both sides of the upper and lower jaws is completed.

Between the ages of 1 and 6 months very little alteration is noticeable in the dentition of cattle, except that the incisor teeth become less crowded, the jaws larger, and the space between the third molar and the angle of the jaw increases as the fourth molar, or first permanent tooth, advances to its place; and at 6 months the latter is well developed, although often in close contact with the angle of the jaw, and not yet free from the covering of gum on the posterior surface. Little change is then noticeable in the teeth of the ox until it attains the age of 1 year, except that the incisor teeth become worn, and the spaces between them increase in size. Thus, it is difficult to determine the exact age of an animal about this period. Shortly after 1 year, however, the fifth molar begins to develop, and is well cut at about 15 months.

In forward animals, the first change in the incisor teeth may take place as early as 1 year 7 months, when the two central temporary incisors are replaced by permanent teeth, which, however, are more usually cut at about 1 year 9 months, and in any case do not become level with the other incisors until close upon 2 years of age, and at this age also the sixth permanent molars are cut.

When the second pair of permanent incisors, or broad teeth (sometimes called "middles"), have been cut and become well developed, it may usually be taken for granted that the animal is above the age of 2 years, as these teeth are usually well up at 2 years 6 months. There are instances, however, when dentition is very backward, where the middle permanent incisors are not cut until the animal is nearly 3 years old.

At from 2 years to 2 years 3 months the change of the temporary anterior molars to permanent teeth will be proceeding. Some of the new teeth will be cut, and several of the temporary teeth still remain in position until 2 years 6 months, when the newly cut permanent teeth will be in the majority, while at 2 years 9 months all temporary teeth will have disappeared and the molar teeth become level, although those of later formation will show no wear.

The third pair of permanent incisors will usually have become well developed at about 3 years. The fourth and last (corner) pair of permanent incisors are cut soon after the third pair, and make their appearance or may become fully developed at anything from 2 years 9 months to 3 years 6 months.

After this it is difficult to tell the age of an animal accurately by its dentition, but the teeth become narrower, yellow in colour, and more widely separated from each other year by year, while the worn surface becomes much broader. Thus, in a cow or bull that has attained the age of 5 years, the first three pairs of incisors will show a considerable amount of worn surface, and the cutting-edge of the corner teeth will also have become worn. The changes, however, after this period are not sufficiently definite in character to enable any very accurate estimate of the age to be arrived at.

## CHAPTER IV.

### SHEEP.

It is difficult to overrate the importance of sheep as wool- and meat-producers. The prestige of the woolsack as the seat of the Lord Chancellor is alone sufficient to indicate the estimation in which wool was held in England in the Middle Ages, and a review of the products of Australia, New Zealand, and other British Colonies would demonstrate that wool is a principal commodity. It ranks with cotton, for woollen and cotton clothing divide the attention of every individual throughout the civilized world. The flesh is of equal importance with the wool, for just as cattle supply us with milk and beef, so do sheep with cloth and mutton.

The changes which have taken place in the flocks of Great Britain during the last fifty years are remarkable. In the early days of the Royal Agricultural Society few breeds of sheep were recognized, and Leicesters and Southdowns—long-wooled other than Leicesters, and short-wooled other than Southdowns—concluded the prize schedule ; but now there are at least twenty-six Breed Societies, and the country is divided among the races they represent in varying proportions. There is no "best" breed of sheep, for each has its own particular traits of character, some being adapted for mountainous and exposed situations, some for low-lying pastures, some for ranging over unenclosed moors and fells, and some for folding on arable land. It is not our intention to describe these numerous races of sheep, for, as in the case of cattle, so with them, they may in many respects be simply treated as sheep.

Sheep are all alike in voice, and are very similar in their habits, their ailments, their food, and their management. All of them may be considered as ewes, rams, wethers, or lambs ; and a man who understands sheep will soon pick up the points of management in which one breed differs from another.

To describe the points of all the breeds would alone require much space, and the authors feel that information upon these matters is obtainable in countless books and articles. It forms the substance of most works on sheep, and to reiterate seems superfluous. We shall, therefore, in the following remarks consider a sheep as such, and shall find abundant material in the common interests which surround all flocks. It is true that there is a wide difference between the management of Highland and Lowland sheep, but these can be glanced at as they present themselves, and we shall follow the same broad lines of breeding, rearing, and management as we have already done with regard to horses and cattle.

Sheep-breeding is carried on upon the less fertile soils of the country. It forms a highly important industry in the Highlands of

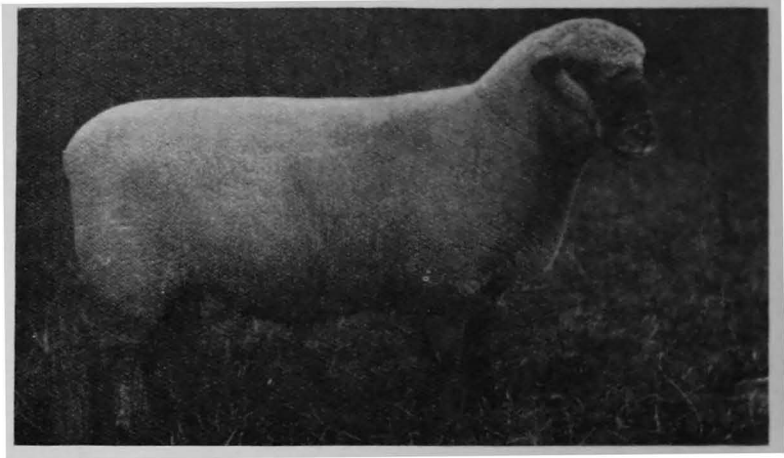

FIG. 103.—Hampshire Down Ram.

Scotland, on the Cheviot Hills, the extensive moors and waste lands of Northumberland, Durham, Yorkshire, Lancashire, and Derbyshire, as well as in the Lake District of Cumberland and Westmorland, and

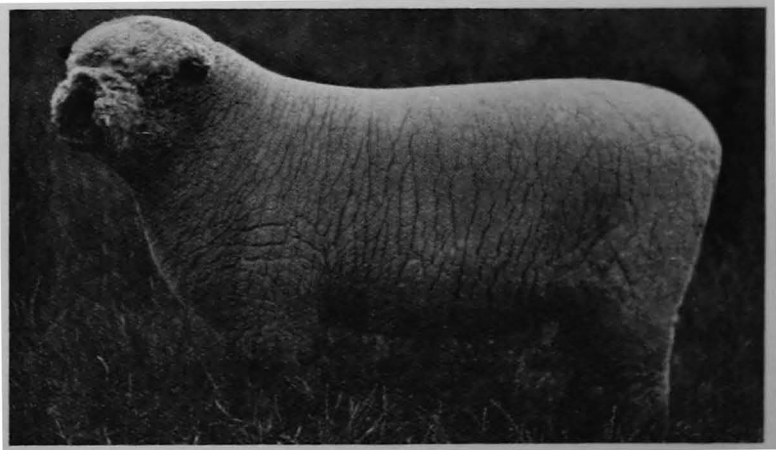

FIG. 104.—Shropshire Shearling Ram.

this will be seen to include all the northern counties of England. It rises into importance as the country rises in altitude, as for

example on the wolds and heath of Lincolnshire, and the high-lying downs of the chalk counties already mentioned in our sketch of the

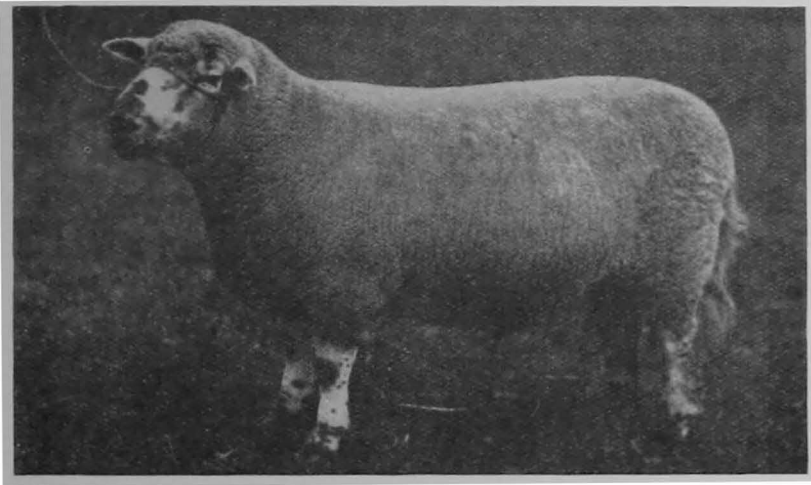

FIG. 105.—Kerry Hill Ram.

distribution of soils (p. 20). It is a principal object with the farmers of the Pennine Range, the Cotswold Hills, and the Welsh mountains.

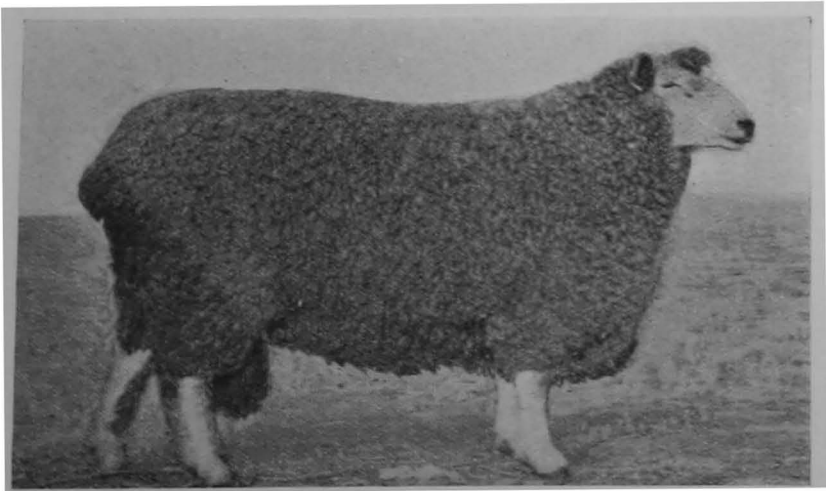

FIG. 106.—Roscommon Ram.

Sheep prefer high-lying land and dry conditions. They are wonderfully independent of water, although it is a glaring error to



allege that they do not drink. Ewes are better on poor land, and if they are kept on good land, and become fat, they arrive at their maximum value, which at once suggests the advisability of selling

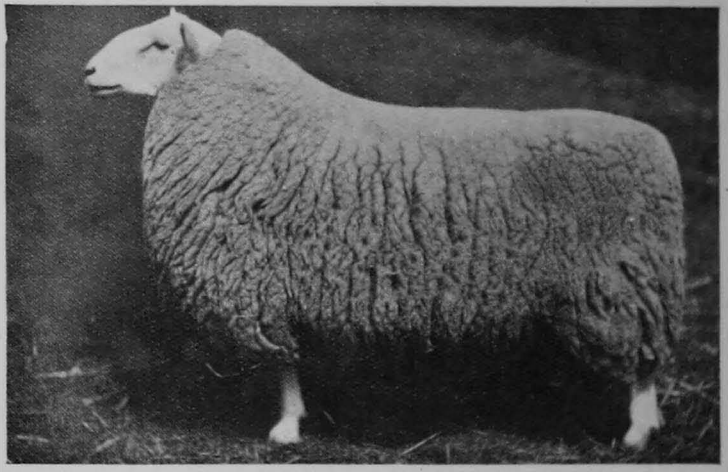

FIG. 107.—Cheviot Ram.

them before they go back in condition. Ewes ought to be kept in good store condition, and this is best effected by grazing them on low-rented, dry, and thin soils, overlying chalky or limestone

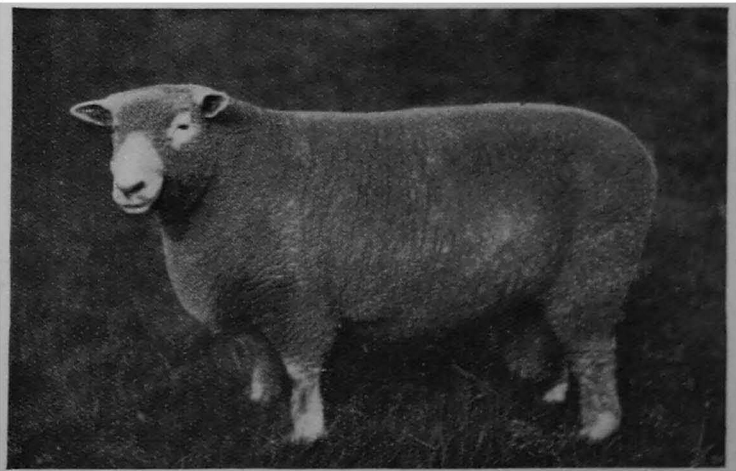

FIG. 108.—Ryeland Ram.

rock. This condition favours fecundity, and is the healthiest state for pregnant ewes. It at once suggests the best use for vast areas of poor land carrying short and sweet herbage, and this divides the

country into breeding and grazing districts. It is also at the foundation of a system in which, at the close of summer, the hill farmers part with their surplus stocks of lambs to lowland farmers, who purchase them for fattening upon turnips. During August, September, and October sheep fairs are held all over the country, in which lambs change hands; and the hill farmers only winter their old and young ewes, and prepare for another "crop" of lambs for the succeeding season. We therefore find that while on breeding farms the heaviest stocks of sheep are found in summer, the reverse is the case on arable lands, where winter grazing is the principal object.

**Management of a Ewe Flock.**—A constituted and permanent flock consists of ewes of different ages. There are first the over-age ewes,

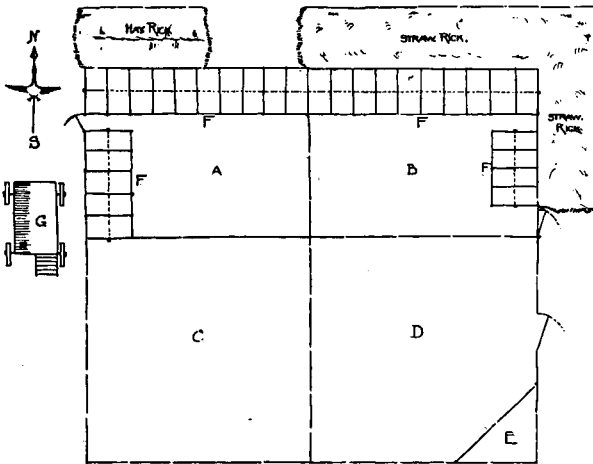

FIG. 101.—Plan of Wiltshire Lambing Pen. A, yard for ewes about to lamb; B, ewes and young lambs; C, ewes and older single lambs; D, ewes with twins; E, corner for lambs; F, coops for newly lambed ewes; G, shepherd's hut on wheels.

which are retained in the flock on account of their perfect health and strength, or their reputation for breeding good lambs and being good mothers. Such old ewes are well known to the shepherds and often bear names. They are "sound in tooth and bag", and sometimes continue for several years after the usual age for drafting. Ewes have been known to breed up to 13 or 14 years of age, and these favourites lead the flock and often carry bells. They are, however, exceptional, for the rule is "three crops of lambs and away", which being interpreted is, that ewes are drafted at  $4\frac{1}{2}$  years old. They produce their first lamb at 2 years old, their second at 3 years old, and their third and final crop at 4 years old, and are then sold as draft ewes, still fit for breeding, at  $4\frac{1}{2}$  years old. This is what is called the

"usual draft", and ought not to contain any over-age ewes, nor any defective in tooth or udder, or barren, ruptured, or disqualified for breeding. They are often bought by occupiers of a better class of land, to produce one more "crop" of lambs, and may be sold off fat at the same time as, or earlier than, their progeny. This is called a "flying flock", and serves to show the difference between a permanent flock and one which is replaced every year.

**Cull Ewes** differ from the usual draft in being what may be called a scratch lot. They consist of confirmed barreners, broken-mouthed and defective ewes, not fit for breeding, but capable of being fattened. They are sold at several shillings per head less than the usual draft, and are better got rid of early in the season, or as soon after the lambs are weaned as possible.

**Remaining Sections of the Flock.**—The stock ewes comprise full-mouthed, 6-teeths, and 4-teeths, which are respectively 4, 3, and 2 years old; and the entire flock also contains 1-year-old ewes or 2-teeths, also known as shearlings, gimmers, or theaves; and the ewe lambs of the current season, which are spoken of as stock lambs, because they are intended to come into the flock in due course. This

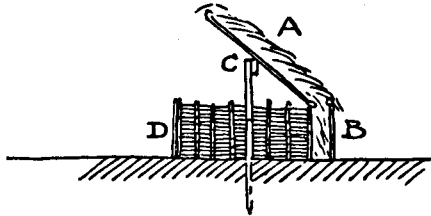

FIG. 110.—Section of Lamb Coop. A, sloping thatched hurdle resting on rail, nailed from post to post; B, double stuffed row of hurdles; C, 5 ft. post 15 inches in ground; D, hurdle dividing coops, which are closed in on inner side by hurdles (see Plan).

is the entire flock, excepting the rams or sire sheep, some of which are bought yearly at ram sales, while others are kept on for use in future seasons.

**Drafting Ewes.**—After shearing, the flock is closely inspected, and the culls and draft ewes removed. All undersized, badly coloured, loose-fleeced, and ill-formed animals are taken out, and the 2-teeth ewes replace them. They are then marked according to age, the 2-teeth on the near shoulder, the 4-teeth on the rib, the 6-teeth on the haunch, and the full-mouthed ewes on the far haunch. If the drafting is close or severe, the flockmaster makes up his number by a few purchases from other breeders of similar standing to himself.

Mating may take place from July to November, according to the breed and locality. Dorset ewes will take season earlier, but in most other cases August and September are the usual months. Black-faced mountain ewes take their season in November, and produce their lambs in April. The period of gestation is twenty-one weeks, and lambing time is reckoned from the first day the rams are turned

out. It sometimes begins in December, but strictly speaking, and for show purposes, a lamb should be born within the year in which it is exhibited. January is a favourite month for lambing in the case

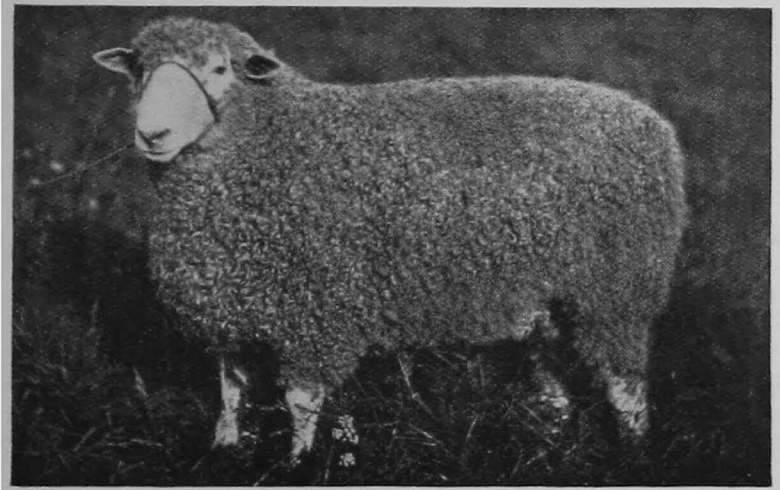

FIG. 111.—Leicester Shearling Ram.

of many Down flocks, but February may be thought more seasonable. Many lambs fall in March, and late ewes may not produce till April or May.

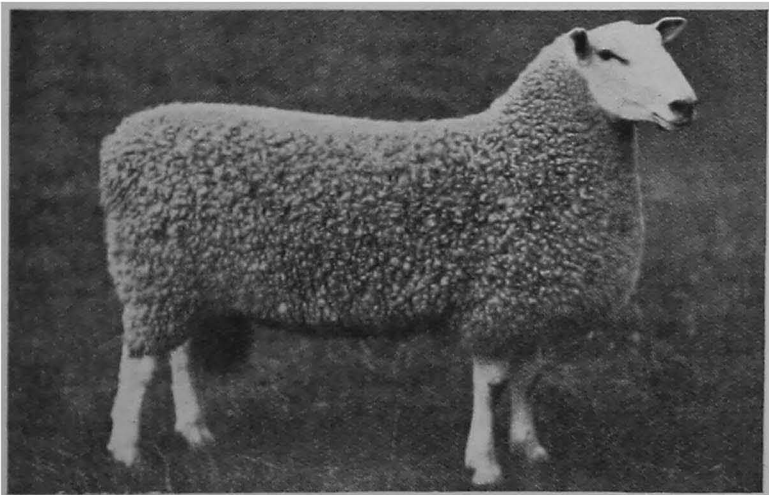

FIG. 112.—Border Leicester Shearling Ram.

The selection of rams is a matter of supreme importance, especially with ram-breeders, and fixtures for ram sales are well attended by flockmasters and their shepherds. Very high prices are given

250 LIVE STOCK, FEEDING, AND ECONOMIC ZOOLOGY.

every season, and the late Mr. Henry Dudding made 1,450 guineas of one Lincoln shearling ram in 1906. One hundred guineas is not uncommon, but averages of £16 to £20 over 100 sold is thought

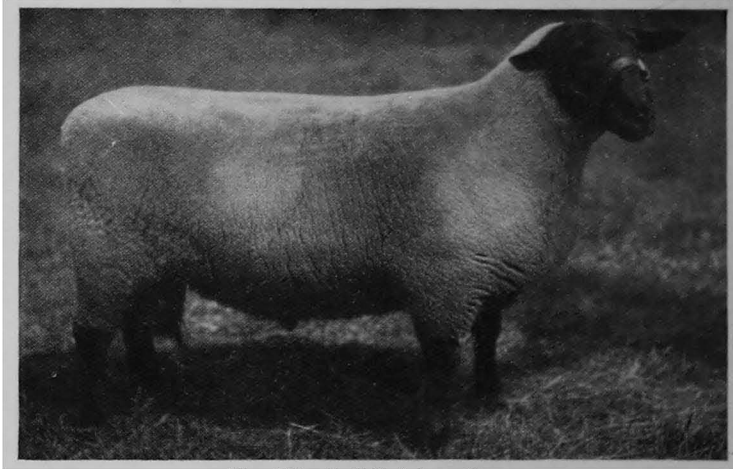

FIG. 113.—Suffolk 2-shear Ram.

very good. There are, however, always opportunities for purchasing equally well-bred rams at from 5 to 10 guineas each, after the ram-breeders have chosen their lots, and it is quite possible that an

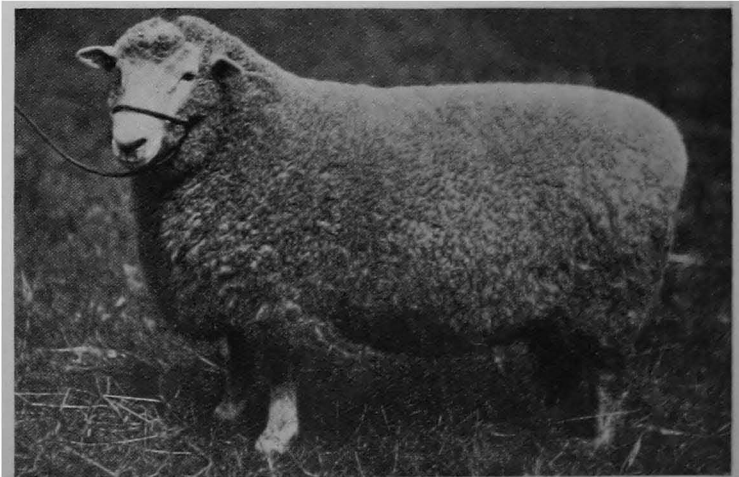

FIG. 114.—Romney Marsh 2-shear Ram.

equally good ram may fall at quite a moderate figure. The competition between breeders drives up the price of certain lots, while others arouse no keen rivalry, and therefore fall to a reasonable bid.

The selection of rams occupies much attention in late summer. They must be of pure blood and free from faults. They are chosen with a view to correcting the weaknesses of the flock, such as lightness

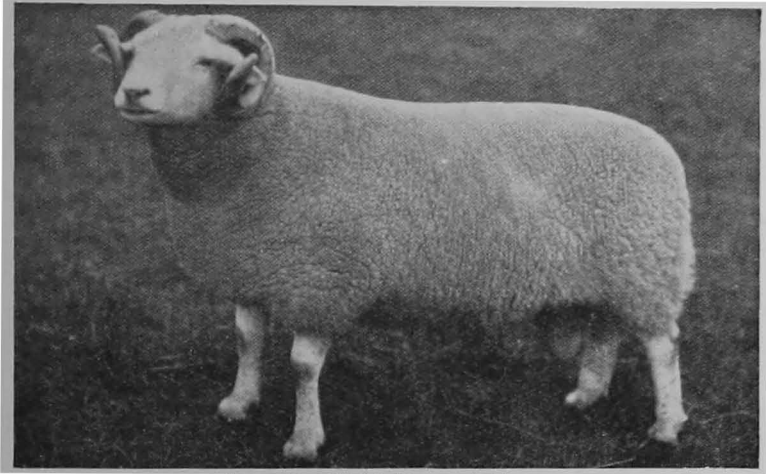

FIG. 115.—Welsh Mountain Ram.

of fleece, neck, or forequarters. It is difficult to breed out faults, but every breeder believes that it can be done; partly by weeding out faulty females, and partly by selecting males which excel in the



FIG. 116.—Wensleydale Ram.

points in which the flock is deficient. The object of the flockmaster is to weed out ewes which are not up to his standard, to introduce an improved lot of 2-teeth ewes, and to look out at replenishing sales

for good pens of five or ten young ewes, to keep up his number. It is by persevering in these methods that a flock gradually rises in estimation in its neighbourhood, but it requires a long time, and



FIG. 117.—Dorset Horn Ram.

high merit is often only accomplished after a lapse of fifty or sixty years. There is, however, a shorter method open to rich men, namely, buying at dispersal sales and securing a ready-made flock. This



FIG. 118.—Black-faced Ram.

transference of an entire flock is not uncommon and places the buyer at once on a pedestal, which, however, he may find it difficult to maintain.

*Mating* is the commencement of a new season for a flock. It has been drafted and replenished, and the next great event to look forward to is lambing. Ewes should be placed on better keep than usual before

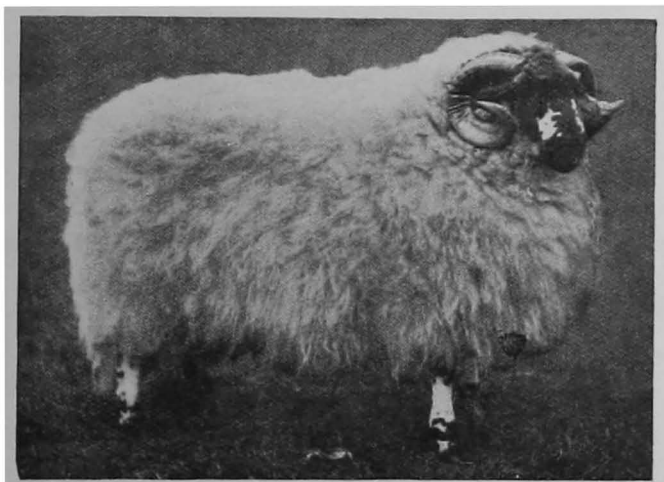

FIG. 119.—Lonk Ram.

the rams are turned out, but should not be fat. They should be in improving condition, and on arable farms are allowed turnips, rape,



FIG. 120.—Herdwick Ram.

white mustard, and good grazing. This secures quick mating, and as a consequence an early and fast lambing time, with lambs of nearly the same size and age.



The ewes are divided into lots, and in ram-breeding flocks into many small sections, according to their breeding and the character of the rams to which they are put. They are carefully marked and



FIG. 121.—Dartmoor Ram.

registered for the purpose of siring the lambs, but a less rigorous system is used in ordinary working flocks. We cannot enter into all the details and dodges employed for securing conception and



FIG. 122.—Exmoor Ram.

avoiding "turning", but they are numerous, and constitute part of the lore of shepherds. As ewes are seasoned, they are taken out and sent on to poor keep, and this is considered advisable for several

reasons. It is better for the ewes, as more likely to ensure safe conception, and it is economical in cost. Ewes run on poor keep up to within a fortnight of lambing, and are then given a little more indulgence in order that they may be robust for parturition, and yield a good supply of milk. On no account, however, must they be over-fed, but, as before stated, maintained in good store condition.

**Lambing.**—When lambing takes place in winter, a shed or comfortable pen must be provided (Fig. 109). It may be a permanent enclosure, or it may be customary to devote a barn or sheltered yard to the purpose. On large sheep farms it is often temporary, and formed by thatched hurdles further protected with straw and hay-ricks on the exposed sides. This is the pen, and the inside is further divided into yards by cross lines of hurdles. Small coops or cells (Fig. 110) are made round the inner margin as follows: First, 5 ft. piles are driven

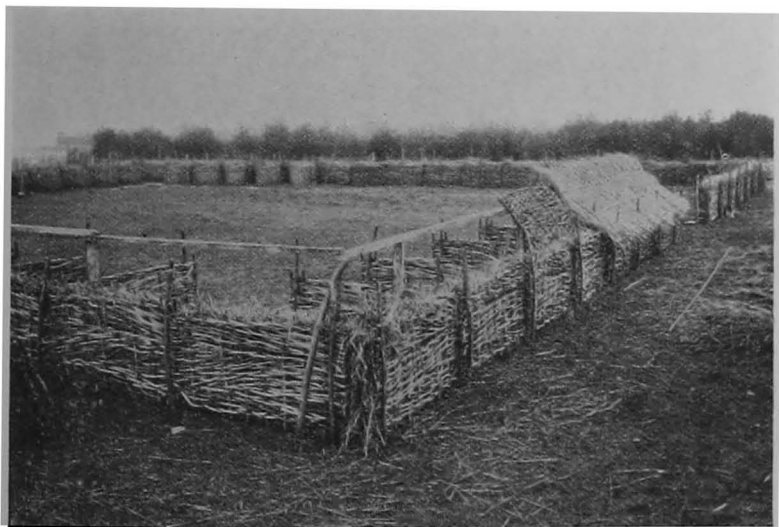

FIG. 123.—The Lambing Pen.

into the ground 12 feet apart, in such a manner as to mark out a rectangular space of, it may be, a quarter of an acre in extent, according to the size of the flock. A rail is then nailed from top to top of the piles, and about 2 feet outside a rampart of thatched hurdles is firmly pitched. Other thatched hurdles are then laid from the tops of the outer row, and made to rest on the rail, which gives a sloping roof, and converts the inner side of the pen into a long shed. Cross hurdles are then pitched 6 feet apart at right angles and abutting upon the outer row, and this divides the shed into stalls, which again are converted into cells or coops by placing a row of hurdles in front of them. Thus the enclosure is surrounded by cribs on its inner circumference, and the remaining space is littered and made comfortable for ewes and older lambs.

The yards are devoted to different classes of inmates. One may be used for unlambed ewes, although it is better to keep these in an open fold outside the pen. Another is used for twins or "double couples"; a third for single ewe lambs, and a fourth for single ram lambs—the dams, of course, being with them.

It is a lively scene in the height of the season, and outside is the shepherd's house on wheels, furnished with a stove and a bed, as the work goes on night and day, and there is little time for rest. A good and skilful shepherd is a most valuable aid, and often remains all his life with the same master or his family. He is very trustworthy, but always prefers his master to visit the pen daily and discuss points of management. Shepherds are the same in all parts of the country, keen about their sheep, and apparently thinking of little else. They are a little superstitious, generally high-principled, and often hereditary as to their pursuit.



FIG. 124.—Sheep Dipping.

**Difficulties in Lambing Time.**—The shepherd has to contend with many difficulties. He has awkward cases of parturition, in which he is fairly skilful, but he has also to cope with inflammations and inversions of the uterus, absence of milk in the ewes, weak or orphaned lambs, outbreaks of persistent "scour" or virulent diarrhœa, naval and joint ill, etc. The fundamental causes are sometimes difficult to trace, but many of them are due to errors or misfortunes which took place many weeks previously. Such are heavy and continued rains, lightning, snow and sleet storms, bad lying, irregular feeding, errors in diet, disturbance by stray dogs, hounds, etc. The more immediate causes may be overcrowding in the fold or pen, filth, and bad smells. A lambing pen is liable to become foul, and the master should see that all dead sheep and lambs, cleansings, skins, or any other offensive matter should be cleared away, and the pen well replenished with fresh straw. It will also be well to remove the stronger lambs and

their dams to a distance, and to erect a new pen consisting of a fence of thatched hurdles against the prevailing wind, and a litter on the leeward side.

**Ewe Keep.**—So far as feeding is concerned, the year may be divided into four parts beginning with the weaning of the lambs. The ewes are then placed on distinctly poor keep in order to dry up the milk, and then they continue until within a month of the mating season, when they should be placed on better keep. After seasoning they are again kept on spare diet, until the approach of lambing time. After parturition they may be fed much more liberally, with the object of stimulating the flow of milk. On arable farms the ewes clear up what the lambs reject, on vetch, rape, or cabbage folds, or act as scavengers to the more pampered sections of the flock. The 2-teeth ewes are given a preference as to food, because they are in a growing state, and it is well to develop their frames to their full stature and weight.



FIG. 125.—Southdown Ewes.

**Lamb Keep** differs materially from ewe keep. It must be young, fresh, and varied, and it does not answer to fold lambs over the same ground twice, or on second growths. Ewes, on the other hand, will pull out old grass, clear up after lambs, and do well on second growths of rape or cabbage. It is quite possible that a farm may abound in ewe keep, while at the same time it carries nothing fit for lambs.

**Management of Young Lambs.**—Lambs are weaned when they are from 12 to 16 weeks old, and often wean themselves. Their management on arable land consists in folding them on a series of crops, such as turnip- and rape-greens, rye, winter barley, trifolium, vetches, and rape, or cabbage. They are weaned either on trifolium or vetches, and may be receiving corn and cake during the entire period. Much depends upon the object in view. If intended for stock, as in the case of ewe lambs, concentrated foods are not

necessary, and they do well upon their mother's milk, hay, turnip-greens, etc., according to the season; neither is it necessary to "cake" their dams. Wether or ram lambs are pushed on as rapidly as possible, with the aid of artificial foods of all kinds, and the ewes are helped with cake, especially if they are mothers of twins. It is the usual custom to allow all lambs to run forward through creeps or lamb hurdles, so as to give them a full choice of food; and their small troughs are placed outside the hurdles. The ewes occupy the fold and eat up what is left by the lambs, both of greens and roots.

On grass lands the method used is simpler and consists in open grazing, on young seeds and pastures. The couples are turned out on to young rye grass and clover, and are shifted to new ground as soon as the food is exhausted. Frequent changes are always considered important, and deserve more extended notice.



FIG. 126.—Cotswold Ewes.

**Importance of Change of Food for Lambs.**—In districts where lamb feeding is carried on to the greatest perfection, flockmasters rely on frequent changes of food, and in many cases arrange for three or four a day. For example, ewes and lambs may rest at night upon a fold of turnip-greens and rape, and be taken on to green rye during the day. Or they may be on roots with springing tops, and then folded on water-meadows, the lambs being allowed to run forward through lamb hurdles. They are then brought back to their night fold. In the height of summer, lambs may sleep on vetches, breakfast on cut mangel-wurzel and cake, lunch on rape, enjoy a run, or "spread", upon clover aftermath, and return to a fresh fold of vetches in the evening. It is by this continuous change of green food, and an abundant and varied allowance of cake, mangel, beans, malt, and cut hay-chaff, that lambs are brought to a large size by August, and are sold at prices ranging from 40s. to 60s. each, either to butchers, or to graziers for finishing.

**Ram Lambs** are similarly treated, but require more care, as they are liable to suffer from being over-done early in the season. They become too heavy, coarse in wool, and go rusty in face. They may also "peel" or lose their wool, especially on the head and scrotum, and this greatly interferes with their sale. Ram lambs should not be forced in early spring; and extra hard feeding should be reserved until within a month or six weeks of their sale.

**Quantities of Cake and Corn.**—A sheep well supplied with green fodder or roots is not capable of eating more than about 2 lb. per day of cake and corn. Lambs may be commenced with an allowance of 2 to 4 oz. each, and gradually increased to  $\frac{1}{4}$ ,  $\frac{1}{2}$ , and 1 lb. per day, which is liberal feeding. Exhibition and ram lambs seldom eat more than 2 lb. each per day, as may be ascertained by inquiry. Shepherds prefer to deal in measure rather than weight, and 1 bushel to the 100 is thought by them to be a fair start, i.e. about 44 lb. to the



FIG. 127.—Dorset Down Lambs.

100. Progression is marked in bushels per 100, but the writer has never known 5 bushels to 100 exceeded, or about 2.2 lb. each. This amount is, however, considered extraordinary. A pound of cake is a standard allowance for ewes, and  $1\frac{1}{2}$  lb. a fair maximum for fattening tegs.

**Management of Tegs on Turnips.**—A teg is a young sheep, and retains the name until it is shorn, when it becomes a shearling. Other terms are used, such as hoggs, dinmons (wether tegs), and chilvers (female lambs or tegs). Theaves is a term largely employed in the south and west for 2-teeth ewes. Lambs are called tegs when they go on to turnips in the autumn, and may then be spoken of as fattening tegs. They may be of small or medium size; or they may be heavy, and nearly ready for the butcher. Their management depends upon their size and condition. What are called "forward" tegs ought to be pushed on vigorously, so as to be brought out fat by Christmas.

Smaller and younger tegs are better run on grass till November, and then brought on to turnips, and later folded on swedes. They are often carried on till after shearing time, and finished during the summer on green fodder. The case is parallel to that of cattle, which may be half-fat when put up, and only require a few weeks to finish ; or young and poor, and occupy the stall the entire season. Some graziers prefer to turn out two lots of tegs during the season, and some are content with only one, but much depends upon the character of the land.

Taking the more gradual process as a type, tegs will not at first require more than  $\frac{1}{4}$  lb. per day of cake, or mixed corn and cake, and this may be increased to  $\frac{1}{2}$  lb. by Christmas, to  $\frac{3}{4}$  lb. late in January, to 1 lb. in March, and to  $1\frac{1}{2}$  lb. towards the close of the season, when they may be supposed to be ready for sale, either shorn or rough.

In these days, 10 months is often spoken of as an age at which tegs should be ready for slaughter, and they will then have attained



FIG. 128.—Oxford Down Ewes.

a carcass weight of from 16 to 20 lb. per quarter if fairly bred. Tegs on turnips must be regularly fed, and the fold regularly shifted. They will be able to "break" their own turnips until January but when they are placed on hard swedes, and begin to shed their incisor teeth, the roots should be passed through a cutter and given in troughs. These are filled three times a day, morning, noon, and towards evening, and they receive dry fodder before their first feed of roots. Their cake may be given at noon, and this will induce them to eat more juicy swedes ; and they should be "hayed" the last thing before the shepherd leaves them for the night. According to this system they will receive six meals during the day. The turnip troughs should be kept clean, and the cake troughs dry, by turning them over.

Sheep for Small-holders.—It will be readily seen that sheep are better adapted for large farms than for small holdings. The changes



Smaller and younger tegs are better run on grass till November, and then brought on to turnips, and later folded on swedes. They are often carried on till after shearing time, and finished during the summer on green fodder. The case is parallel to that of cattle, which may be half-fat when put up, and only require a few weeks to finish ; or young and poor, and occupy the stall the entire season. Some graziers prefer to turn out two lots of tegs during the season, and some are content with only one, but much depends upon the character of the land.

Taking the more gradual process as a type, tegs will not at first require more than  $\frac{1}{4}$  lb. per day of cake, or mixed corn and cake, and this may be increased to  $\frac{1}{2}$  lb. by Christmas, to  $\frac{3}{4}$  lb. late in January, to 1 lb. in March, and to  $1\frac{1}{2}$  lb. towards the close of the season, when they may be supposed to be ready for sale, either shorn or rough.

In these days, 10 months is often spoken of as an age at which tegs should be ready for slaughter, and they will then have attained



FIG. 128.—Oxford Down Ewes.

a carcass weight of from 16 to 20 lb. per quarter if fairly bred. Tegs on turnips must be regularly fed, and the fold regularly shifted. They will be able to "break" their own turnips until January but when they are placed on hard swedes, and begin to shed their incisor teeth, the roots should be passed through a cutter and given in troughs. These are filled three times a day, morning, noon, and towards evening, and they receive dry fodder before their first feed of roots. Their cake may be given at noon, and this will induce them to eat more juicy swedes ; and they should be "hayed" the last thing before the shepherd leaves them for the night. According to this system they will receive six meals during the day. The turnip troughs should be kept clean, and the cake troughs dry, by turning them over.

Sheep for Small-holders.—It will be readily seen that sheep are better adapted for large farms than for small holdings. The changes



of food and the open grazing are not suitable for small areas ; and sheep farming, both in this and other countries, is chiefly carried on upon extensive tracts.

**Other Annual Events.**—There are several other events which mark the seasons, which cannot be at present enlarged upon. They may, however, be enumerated as follows : castration and tailing, weaning, washing, shearing, dipping, marking, and drafting. During the spring, summer, and autumn the greatest vigilance is required to protect the flocks from attacks of flies, which deposit maggots in the wool, and settle on the heads of the sheep. A large part of the shepherd's time is occupied in looking out for and treating these cases, especially in warm and showery weather.

**Sheep-dipping Appliances.**—Sheep used to be dipped by simply pouring the solution on to their backs and rubbing it into the wool by hand. Various kinds of baths have now been introduced, however, and the work is in consequence done much easier and quicker.



FIG. 129.—Lincoln Ewes (in full fleece).

**Hand- and Swim-baths.**—Hand-baths for small flocks are made of wood, earthenware, or galvanized iron, and measure about 4 feet long, 2 feet wide, and 4 feet deep. A corrugated draining rack is also provided on which the sheep may stand to drain, and the solution that runs off may be collected and put back into the bath. In some hand-dippers a ladder is provided, jointed in the middle ; on raising a lever the ladder collapses and lies close against the end and bottom of the bath, and the sheep cannot rise from the dip until it is raised again. The collapsible ladder also keeps the solution in the bath well stirred.

Another kind of bath for dipping sheep is the swim-bath (Fig. 124), which is safer for in-lamb ewes and involves less labour than the hand-bath. Large sheep farmers need a permanent concrete, stone, or brick swim-bath. The dimensions of such a bath should be about

3 feet deep, 20 inches wide at the top, 12 inches at the bottom, and 12 feet long, with a sloping walk-out at one end about 6 ft. 6 in. long. Smaller temporary swim-baths are generally made of galvanized iron; the sheep are put in at one end, and after swimming the length of the bath leave it by a gradual slope at the other end; in some makes there is a gate in the centre to prevent the sheep getting out too quickly. For small flocks the cage dipping baths are very useful. These consist merely of a galvanized iron tank sunk level with the ground, into which each animal is lowered in a wire cage by means of a windlass.

*Portable Dippers.*—Portable dipping machines have lately been placed on the market, whereby sheep can readily be immersed in the various preparations used for the destruction of ticks, lice, and all parasites, at any spot which appears most convenient for the purpose. The machines are built in cart form, being light in construction and mounted on springs, the total weight not exceeding 2 cwt. The wheels, axles, and springs are readily removed by raising the shafts until the bottom of the tub touches the ground; then the wheels are run from under the machine and the tub let into the ground to a depth of about 20 or 22 inches. A drainer or run-off board is then attached. A machine of this type is capable of dipping one thousand sheep daily.

*Sheep-dips.*—There are many sheep-dips and it would occupy too much space to enumerate them. This is the less necessary, as well-known arsenical and non-poisonous dips are on the market ready for use. As our space is limited, all we can say is that the directions on each packet should be carefully read and observed. It is dangerous to dip sheep twice within less than, say, one month between the dippings, i.e. in arsenical mixtures. Sheep ought to be allowed to become cool and quiet before dipping; they are better not dipped in blazing hot weather; they seldom swallow the dip even when plunged over head, but close their mouths and nostrils. Poisonous effects are more likely to be produced by sub-cutaneous absorption than by swallowing, and this is not to be feared in first dippings, when the skin is protected by grease. It may, however, occur in a second bath when the skin is cleansed and open. For this reason a considerable interval should be allowed. Government regulations prescribe one dipping in the year, after which further dipping is not necessary. Still, in cases of outbreaks of scab a second emersion may be ordered, and on such occasions it must be remembered that too quick a repetition may involve dangers which may prove fatal. This fact is not sufficiently explained upon the packets, but may be remembered with advantage. As to a precise period which may be considered safe it is better to dip once a year, and for ourselves we should not care to risk twice dipping in an arsenical dip, within six months of the first.

*Dentition of the Sheep.*—Highly bred sheep, and those which receive a liberal diet complete their dental formation earlier than those which exist under more natural conditions (see Fig. 130). When dentition is complete there are thirty-two teeth in the mouth, comprising eight incisors in the front of the lower jaw and six molars on either side of the upper and lower jaws, while an elastic dental pad

or cushion in the upper jaw forms the opposing surface to the incisors. The latter are flattened on the crown, convex on the outer surface, and somewhat gouge-shape on the inside.

The bars or ridges of the palate thicken as they approach the fore-part of the mouth. There also, the dense fibrous elastic matter of which they are composed becomes condensed, thus forming a cushion or bed covering the convex extremity of the upper jaw. It occupies the place of the upper incisors or cutting teeth, and partially discharges their function. The pad is firmer and denser than in cattle, and yet sufficiently elastic, so that it is in no danger of injury from the sharp incisor teeth below, while the interposed substance is cut through with the greatest ease.

The herbage is firmly held between the front teeth of the lower jaw and the pad above, and is thus partly bitten and partly torn asunder, the characteristic nodding motion of the head of the sheep being sufficient proof of this. The sheep bites more closely than the ox, and is therefore destined to live where horses and cattle would starve. In order to enable the sheep to bite thus closely the upper lip is deeply divided and free from hair about the centre of it.

In many places sheep are put to follow the ox, and are able to gather sufficient nourishment where the ox would be unable to crop a single blade of grass. This answers two purposes: first, all the nourishing herbage that the land produces is gathered from it, and the pasture is made to yield more and maintain a larger head of stock than by any other means. Second, in biting close to the ground sheep not only loosen roots of grasses, disposing them to spread, but also cut off the short suckers or lateral growths, thus causing them to sprout more freely and contributing to the formation of a thick sward of grass.

At birth the whole of the temporary teeth may be discerned in outline, the central incisors being most prominent. Next come the middles, with the remaining lateral and corner incisors considerably below them. Often the cutting-edges of the third and fourth pair

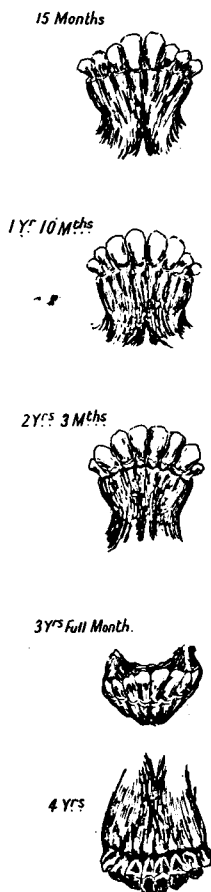

FIG. 150.—Dentition of the Sheep.

are through the gum. At one month all the temporary teeth are well up, including three molars on each side of both the upper and lower jaws. In order to ascertain the age with the greatest accuracy careful examination must be made of the molar teeth, but for all ordinary purposes it is sufficient to take the incisors alone into consideration. At three months the first permanent molar, and fourth in position, is cut, and during the next five or six months the development of the teeth and jaw are the only changes that take place, when at the age of 9 months the space behind the fourth permanent molar is occupied by the fifth permanent molar in position.

The first pair of broad teeth or central permanent incisors appear at the age of from 12 to 15 months. At 18 months the sixth permanent molar in position is cut, and in very forward sheep the second pair of broad teeth will also be cut at this age; otherwise they may not appear until the sheep is 2 years old. Shortly after the protrusion of the permanent molar, sixth in position, the two anterior temporary molars give place to permanent teeth, and the temporary molar, third in position, is then merely a shell covering the top of the permanent tooth.

The presence of six broad teeth usually indicates the age of 2½ years, and where there is doubt, reference must be made to the condition of the molars (Fig. 131), which exhibit very definite and characteristic



FIG. 131.—Molars of "full-mouthed" Sheep.

marks at this period. If in a sheep with six broad teeth the three anterior permanent molars appear just recently cut, and especially if one or more of the temporary teeth still remain, these indications give strong evidence that the age does not exceed 2 years. Six broad teeth, well up, usually indicate the age of 2 years 3 months, while in some exceptional instances these may be cut as early as 1 year 8 months. At the age of 3 years the corner permanent incisors make their appearance, except in breeds of slow development, in which case they may not appear well formed until the fourth year, and then a careful examination of the other teeth must serve as a guide.

At the age of 4 years six of the broad teeth will show signs of wear, the central ones being worn hollow on their upper surfaces. The sharp cutting-edges of the middles and laterals will also have become worn and flattened, thus contrasting sharply with the more recently cut corner teeth.

After the sheep is full-mouthed at 4 years the changes that are effected in the form of the incisors depend upon the food, and afford but little criterion of age.

In selecting sheep for breeding purposes the greatest possible attention should be paid to the teeth, as the digestive organs of ewes with badly formed and broken mouths soon become impaired, and

contribute to many common disorders. Another point of interest is that "shuttle-gobbed", "under-hung", or "parrot-mouthed" sheep, so called by the characteristic malformation of their mouths, cannot graze closely, and consequently are less susceptible to the many parasitic disorders so prevalent among sheep. Such sheep cannot scoop or break swedes like those with normally formed mouths. Folding on hard and frozen swedes is a frequent cause of damage to teeth, and therefore the pulping of roots is advisable for broken-mouthed ewes.

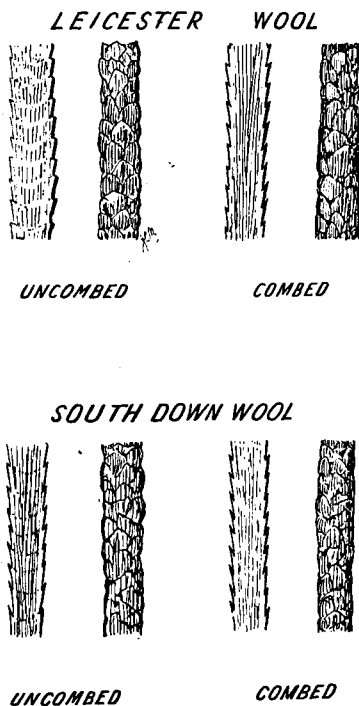

FIG. 132.—Types of Wool.

**Wool.**—The skin of sheep is covered with a fleece made up of coarse, stiff, hair; and wool. The fleece may cover the entire body close down to the feet and forward to the muzzle, or the limbs and the head may be free from covering. Locks of wool may be pointed, cylindrical, or square, and the fleece open, half-open, or close. Wool used in commerce is usually white, this colour being preferred for dyeing.

Experts distinguish wool (Fig. 132) according to its fineness, curves, or curls. The best qualities are flexible, mellow, soft, and elastic. The greasy matter in wool, technically called the "yolk", imparts most of the above-named qualities to the wool. Thus it is important to encourage the production of this secretion in the glands of the skin by suitable feeding and breeding. The best wool is found on the sides of the animals from the shoulders to the croup, while that of inferior quality is found on the withers, back, upper and lower parts of the neck, and under the belly, where it is matted and crushed.

**Sheep-shearing Machines.**—The fact that there are so few expert sheep-shearers now in the country has led to the introduction of these machines, and farmers who find it impossible to gather together a band of expert shearers to complete the work quickly while the weather is favourable, now use them extensively. Among the great advantages to be gained is that the risk of injury due to a man using the machine unskilfully is much less than in that of an unskilled man wielding the old-fashioned shears. Hand, motor, or electrically driven sheep-shearing machines can be obtained, and most of the machines are wonderfully efficient, and all work with a reciprocating action of the knives. The knives are worked by means of a core running inside a flexible tube or case, and suitably geared according to the source of the power available. The older types of machines were subject to much heating and vibration at the knives, but this has now been obviated to a very great extent by the introduction of a ball race between the upper and lower plates of the clipper head. The speed with which sheep may be shorn by machine depends, as with hand-shearing, upon the size of the sheep and the closeness of the wool, but on an average a sheep may be shorn in a little over two minutes.

#### GOATS.

The goat, or as it is sometimes appropriately termed "the poor man's cow", finds most favour amongst small-holders and crofters, or where the milk is in special request for infants and invalids.

Many extinct types of sheep and goats were so similar that there is every reason to believe that both originated from one common ancestor, which might be looked for among the antelopes. In the later types of sheep and goats, the external characteristics become more clearly defined; for example, the coat of the goat is covered with thick bristle-like hair arising out of a covering of soft shorter hair, and attached to the chin is a beard-like appendage, while as regards dentition goats have the incisors more deeply rooted, and the molars thinner with a forward bend.

**Breeds.**—There are many different breeds of goats scattered all over the world, while some possessing identical characteristics are classed under a variety of local names. Distinct breeds are few in number, the principal being the Angora, Alpine, Cashmere, La Mancha, Maltese, Murchian, Pyrenean, Saanen, Schwartzhals, and Toggenburg.

In the British Isles only two varieties of goats are met with, and these are probably indigenous, the one being long-haired and associated with Wales and Ireland, and the other the short-haired or English goat. The horns of the English goat are rather wide apart, rising slightly, with an inclination to branch outwards with a gentle curve, the head being short and tapering, and the body long and deep. The Irish goat is a lean, shaggy animal with a long head and coarse muzzle, and a considerable amount of beard. The horns are long and pointed, and rise almost perpendicularly whilst inclining backward. The colour is generally grey, brown, or black, more or less mixed with white.

The Welsh goat resembles the Irish, but is smaller and more gracefully built.

**Milk.**—The milk of the goat is richer and more easily digested than that of the cow; it is also non-tuberculous—the goat being immune from tuberculosis—therefore proving an excellent dietary for children and for invalids; the digestibility is largely due to the fat globules in the milk being extremely small, and therefore in a more perfect state of emulsion. The milk is whiter than even that of the Shorthorn cow, and varies considerably in quality, containing in some instances over 9 per cent of fat. An average sample exhibits the following analysis: water, 85·7 per cent; casein, 3·2; albumen, 1·1; fat, 4·8; milk sugar, 4·4; ash, 0·8.

The milk can be made into butter, but this, unless it is artificially coloured with annatto, presents an insipid, lard-like appearance. On the Continent the milk is largely used for cheese-making, the most popular varieties being Levrans, Sassenage, and St. Marcellin. A good goat will give 2 quarts of milk a day, when in full milk with its second lot of kids.

**Breeding.**—Goats pair between September and December, but the season may extend to March and April, and they produce their young from February to July, and occasionally in August, but rarely after that month. The male is capable of engendering at the age of 3 months, and the female may produce kids before she is 12 months old, but the age of 12 months in the case of the former and 15 months in the case of the latter is preferable. The period of lactation may last from six to nine months, while in highly-bred animals, specially selected with a view to increased milk production, the lactation period may extend for a whole year, or, if not mated, the goat may continue to give milk continuously for two or three years, the quality decreasing in winter, and increasing again in spring. If milking is not performed at regular intervals, two or three times a day, and the udder is not well stripped, the milk supply will rapidly shrink.

Males not required for breeding should be destroyed, as they do not pay to rear. The average age of a goat is from 8 to 10 years, during the whole of which period it is capable of breeding. Kids should be allowed to suck the dam until they are 8 weeks old, when they should be weaned on grass, hay, and other foods. From one to four kids may be produced at birth, but two are preferable to four weakly ones.

**Feeding.**—Goats differ but little from sheep and cows in their food requirements and method of feeding. The animals prefer to wander

at will over mountainous country where the pasturage is short and sweet. To restrict or tether them on heavy land to a limited area is rarely attended with satisfactory results after the first two or three years. As with cows, goats may be entirely stall-fed, the food then consisting of hay, oats, bran, and maize-meal, and in winter a little linseed cake.

This dietary may be given morning and evening, while throughout the day any clean and wholesome waste garden produce, such as the leaves of winter greens, swedes, mangels, or washed potato peelings, will be relished ; or, to still further comply with their natural inclinations, weeds of various kinds, acorns, and hedge-clippings may be given. Rock-salt should always be kept within reach.



## CHAPTER V.

### PIGS.

ALTHOUGH pigs rank among the less important live stock of the farm in comparison with horses, cattle, and sheep, they are more generally distributed and appeal to a larger public. Most cottagers in the country like to keep a pig, and the same desire extends generally throughout the entire social scale. The secret of this popularity is the elasticity of a pig's appetite—for he is omnivorous. In a wild state the pig is a consumer of roots and herbs, but shows carnivorous tendencies towards reptiles and insects. In confinement he samples everything placed before him, whether animal, vegetable, or mineral, for he crunches up coals and cinders, and in his search for roots picks up a good deal of earthy matter. He is not fastidious, as he will consume rotten eggs in vast numbers, offal of all sorts, sour culinary refuse, and collects food from the most unpromising sources. He is able to convert all this garbage into the most delicate of viands, in the forms of bacon, hams, pork, lard, brawn, sausages, etc., so that he has been appropriately compared to a thrift-box into which anything placed within is transmuted into "gold". This is the province of the pig, and another peculiarity is that, without exception, every part of his body is of value. The bristles supply brushes, the skin is proverbially associated with saddlery, the entrails are used as sausage-skins, the flesh and fat need no recommendation, and the feet or petti-toes are esteemed as delicacies.

The digestive system of the pig is much smaller in bulk than that of ruminants, and one consequence of this is that the proportion of offal is very low, not amounting to more than 16 to 20 per cent. It is the custom to weigh the carcass without removing the head, feet, or skin, and this, in itself, gives an advantage to the fattener, and affords an additional reason why the percentage of dead to live weights is so high.

The above remarks explain the popularity of pigs among so many classes of the community. They are almost essential, for if a householder does not keep a pig he must arrange for the disposal of his wash and refuse to some one who does. In all establishments the piggery finds a place, and every reader knows how necessary these animals are in hotels, asylums, workhouses, reformatories, etc. They are equally important on dairy farms, cheese factories, and slaughterhouses, and it is partly as scavengers and save-alls that they figure in the economy of all farms.

**The Pig for Small Holdings.**—The pig is especially adapted for small holdings. He requires little room, and is patient under confinement. He can be maintained in large numbers without interfering with neighbours, although he may come under the notice

of the Inspector of Nuisances. In this connexion it may be remarked that piggeries should not be erected too near human habitations, and must be kept in good sanitary condition. They may be so simple in construction as to be built by the small-holder with his own hands at little cost. The material may be "slabs" from saw-mills, or old creosoted sleepers from the railways; the roof may be of thatch, fern, or sheets of corrugated iron, and the floors of paving-stones or concrete. The drainage should deliver into a tank, which may consist of a barrel sunk into the ground. The "plant" is therefore simple and inexpensive, and may be made more elaborate, although little will be gained except in appearance.

Pigs are largely kept on the confines of forests, where the villagers have common rights of turbary and of pannage, and the animals return nightly to such humble dwellings as are above described. There can be no better situation for health and fecundity than a common, and

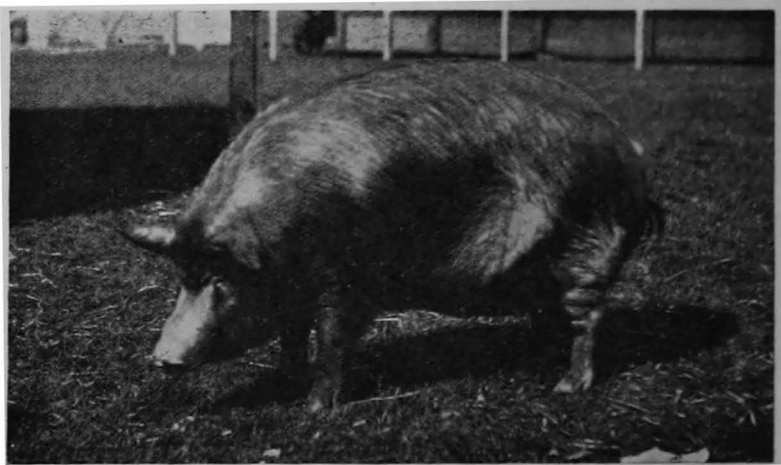

FIG. 133.—Tamworth Sow.

it is in such localities that large litters are produced and sows breed most regularly. Pigs delight to roam and dig for themselves. Although patient in confinement, sows ought to be free, and small pigs are better for having plenty of exercise. The neighbourhood of a forest is therefore peculiarly suitable for pig-breeding, and it is a disadvantage on enclosed farms that sows must be kept within bounds to prevent their intrusion into gardens, or routing up valuable pastures. The pig's paradise is therefore found on spacious village greens, backed by wastes of bracken, and such are also often the homes of small-holders, who turn out their sows to graze at no expense, and derive a substantial source of income from their produce.

On Large Farms pigs are generally regarded as supplementary stock. They are an important adjunct to the dairy, and are useful in cattle yards for consuming refuse food and mixing the manure. They cannot be allowed full liberty, and the sows are confined to

a paddock, which they soon convert into a ploughed field. Pigs on a farm often become trespassers, and are always on the look-out for open gates. They are sometimes transferred to outlying straw yards at a distance from the homestead, where they are fattened on barley meal, and make a great deal of excellent manure.

**Breeds of Pigs.**—There are several well-known breeds of pigs, chiefly distinguished by their colour and size. Thus we have the Large Black and the Large White, the Middle White and the Small White, the Black Berkshire, with white points, the Essex Black, with no white, the Red Tamworth, the Small Suffolk, the White Berkshire (or Coleshill), the Rough White Herefordshire pig, and the Hampshire and Dorset modifications of the Berkshire breed. There are also many crossed breeds, but there is a general similarity in many respects, and the differences are for the most part only skin-deep. There are, however, osteological differences which serve to

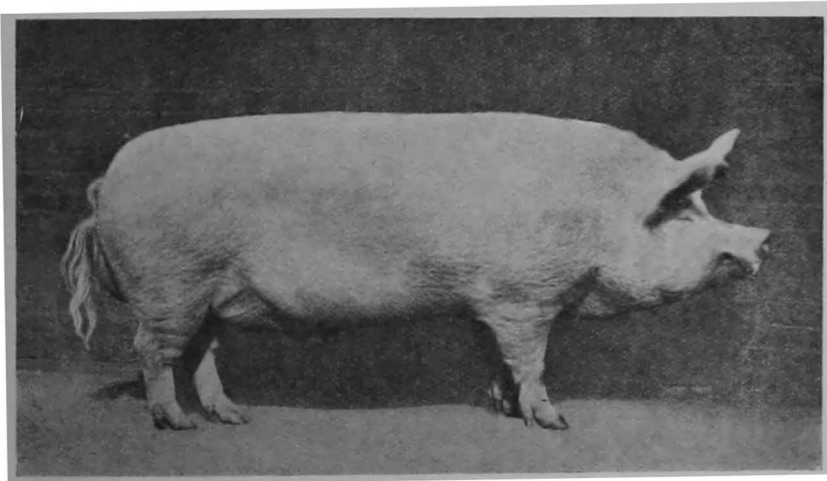

FIG. 134.—Large White Boar.

discriminate races. For example, the Berkshire is short-nosed with broad features and upturned snout, while the Essex is long-nosed and narrow between the eyes, longer in the leg, and flatter on the sides. The small and middle whites are curly-coated, short-nosed, and, when fat, are stertorous breathers, and require a pillow for their heads. The large white races are long in the nose and legs, and covered with long bristles.

The differences in "points" are of course considerable, but all pigs ought to be "long, low, and lusty". In habits, voice, and appetites they all closely resemble each other, and it is not the present object to critically examine smaller differences. When a pig is fat he should be plump and level, and, as an early writer once described a Chinese pig, as like a well-stuffed feather-bed as possible. Any slackness behind the shoulder, or on the ribs, or hams, is objected to, and the back is either straight, or gently arched from ears to tail.

**Fig-breeding.**—The importance of exercise as essential for breeding sows has already been enforced. It is associated with freedom, which cannot always be allowed on farms, but this may be compensated for by a railed enclosure, in which the animals may roam and choose their lairs. A quarter-acre may suffice, and the sows will be found to prefer the open air to the hovels in warm weather.

Another equally important point is the diet, which ought to be of wash or swill, given twice daily, together with green fodder such as vetches or clover in summer, and mangel-wurzel or swedes in winter. Breeding sows should be kept in comparatively low condition, and certainly should not be fat. They are then more prolific, and more likely to breed regularly than if in high condition, and one of the difficulties of breeding pedigree pigs is their tendency to become fat even upon poor keep.

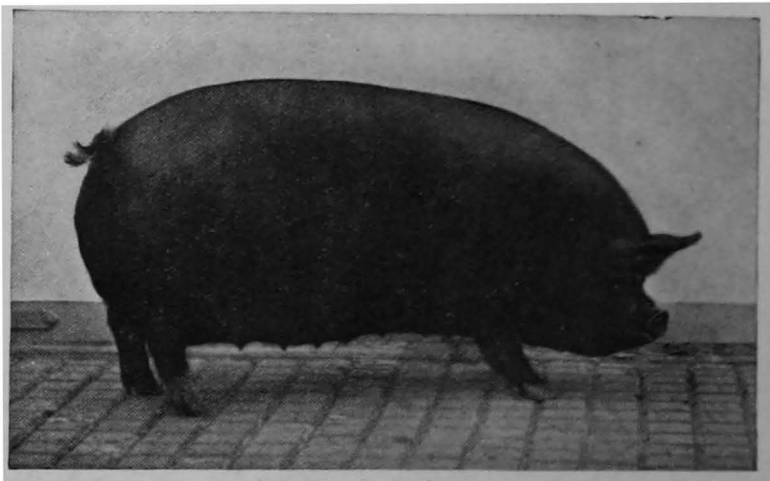

FIG. 135.—Berkshire Sow.

**Selecting Sows for Breeding.**—Sows are generally saved, or kept back for breeding, before the litter is fit for sale and the remaining pigs are disposed of.

They should be well bred, although it does not follow that they need boast a pedigree. It is, however, desirable that they should be well sired, and even where high-class breeding is not the object, most farmers prefer a pure-bred boar. The young sow should be symmetrical in form, of correct colour, long in the body, short in the legs, carry a good head and ears, a well-twisted and complete tail, and a good coat. She should be furnished with a well-placed double row of teats, twelve to fourteen in number, commencing close to the fore-legs, and extending well back between the hind-legs. She, in fact, takes the eye in all respects, and is declared to be fit for breeding. Such young sows should be placed together in a roomy place and kept well, and will be fit for mating when 8 to 10 months old.

Something must depend upon the season of the year, but pigs farrowed in January will be fit to begin breeding in September or

**Pig-breeding.**—The importance of exercise as essential for breeding sows has already been enforced. It is associated with freedom, which cannot always be allowed on farms, but this may be compensated for by a railed enclosure, in which the animals may roam and choose their lairs. A quarter-acre may suffice, and the sows will be found to prefer the open air to the hovels in warm weather.

Another equally important point is the diet, which ought to be of wash or swill, given twice daily, together with green fodder such as vetches or clover in summer, and mangel-wurzel or swedes in winter. Breeding sows should be kept in comparatively low condition, and certainly should not be fat. They are then mere prolific, and more likely to breed regularly than if in high condition, and one of the difficulties of breeding pedigree pigs is their tendency to become fat even upon poor keep.

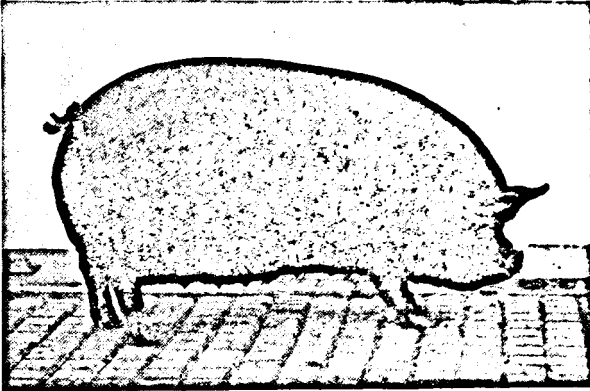

FIG. 135.—Berkshire Sow.

**Selecting Sows for Breeding.**—Sows are generally saved, or kept back for breeding, before the litter is fit for sale and the remaining pigs are disposed of.

They should be well bred, although it does not follow that they need boast a pedigree. It is, however, desirable that they should be well sired, and even where high-class breeding is not the object, most farmers prefer a pure-bred boar. The young sow should be symmetrical in form, of correct colour, long in the body, short in the legs, carry a good head and ears, a well-twisted and complete tail, and a good coat. She should be furnished with a well-placed double row of teats, twelve to fourteen in number, commencing close to the fore-legs, and extending well back between the hind-legs. She, in fact, takes the eye in all respects, and is declared to be fit for breeding. Such young sows should be placed together in a roomy place and kept well, and will be fit for mating when 8 to 10 months old.

Something must depend upon the season of the year, but pigs farrowed in January will be fit to begin breeding in September or

October, and produce their first litters sixteen weeks after mating. This rule will be followed as regards all subsequent litters, for the year is conveniently divided into two periods of six months—four for pregnancy and two for nursing. Thus a sow may farrow in January or February, nurse her pigs till March or April, and produce her second litter in August, or at such time as to allow of her once more becoming pregnant in October and farrowing early in the new year. A sow shows signs of œstrum almost immediately her litter is weaned, and this is of assistance to the breeder, as it indicates the time for mating her afresh. She will come in season every three weeks until she is again in pig, but if pregnancy is long delayed calculations are liable to be upset. A sow will continue to breed for many years, probably from ten to twelve, but her career is generally interrupted by barrenness or some untoward event, such as eating her pigs, or an unwieldiness which causes her to overlay her

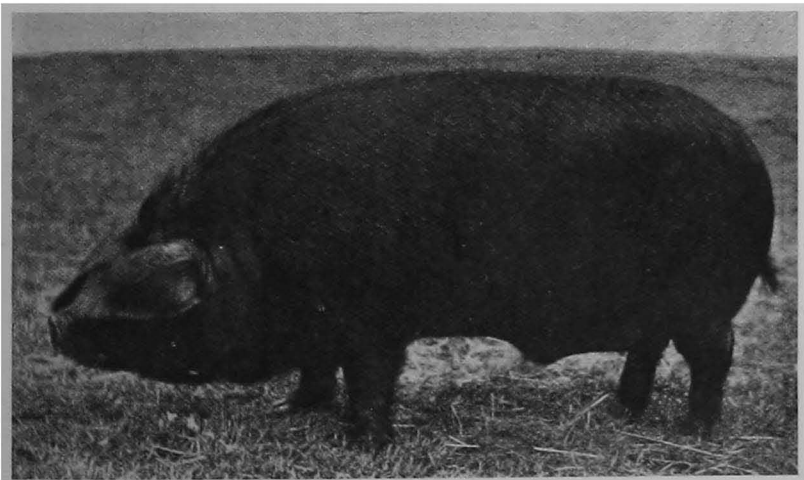

FIG. 136.—Large Black Boar.

offspring. Old sows are also very unsaleable, and even at 3 years old they are difficult to dispose of excepting at ultra-low prices. It is therefore as well to continue breeding from them as long as they give satisfaction.

**Management of Farrowing Sows.**—Towards the close of the period of gestation, sows should be taken in at night. They grow heavy on foot, and the mammary glands begin to develop. They carry straw in their mouths, and are evidently looking for a nest. Sows are remarkably punctual to the day on which they are due, and shortly before it arrives should be placed in a farrowing pen. This should be at least 10 feet square and be easy of access, but quiet and secluded in situation. It is floored with cement over concrete, and is furnished with a horizontal rail, nailed on stout piles, fixed in the floor, about 10 inches from the wall, and placed 2 feet apart. This is to prevent the sow from lying close to the wall, which heavy sows

are very apt to do, as they let themselves down against it, and sometimes squeeze a little pig to death.

The pen consists of an inner den and an outer court, of about the same size ; and the archway between should not be too low, while a door at the back is also convenient for the attendant. Sows are easily upset, and should be kept quiet and undisturbed. The bed of the farrowing sow should be of short litter, and not too abundant, and  $\frac{1}{4}$  lb. of Epsom salts may be introduced into the swill, if she shows any signs of constipation. It is unnecessary to drench a sow, as she will take the salts in her food, and it certainly would not be advisable to use any force or violence.

Sows usually farrow alone and without difficulty. They produce their pigs lying down extended, and as each little pig is born it quickly finds its feet, and in a few moments is seen making its way round its prostrate mother in quest of a teat. It is followed by others, until

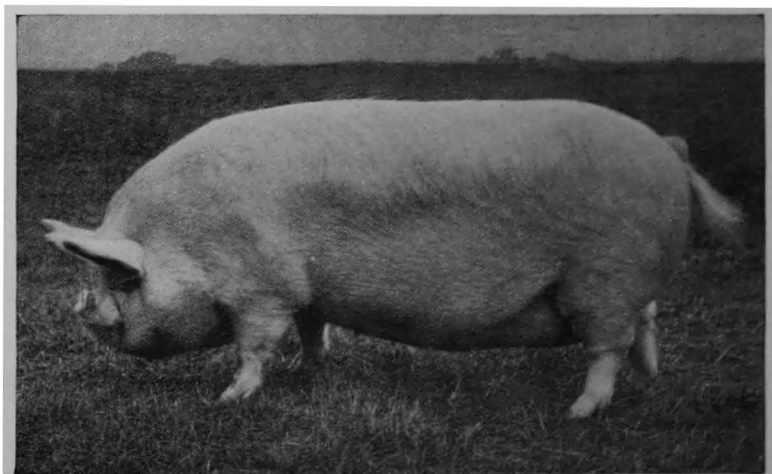

FIG. 137.—Middle White Sow.

the entire litter is born, and each of them sticks to its own teat as a vested interest. The number of pigs varies from six to a dozen, but may fall below or exceed these limits. Twelve is a very good litter, and eighteen is extraordinary. Old sows produce more pigs than do young ones, and a first litter does not often number more than six. As already stated, a farrowing sow should not be disturbed or peeped at, but a careful pig-man will keep an eye to her.

Where valuable sows are kept it has been recommended to remove each pig as born, and return them all to the mother when parturition is over. This seems careful, but, on the whole, the safest plan is to leave the sow and her pigs alone.

**Sows as Mothers.**—Some sows are gentle and others are decidedly cross ; some are so unnatural as to eat their offspring ; but a bad-tempered sow, or one which has once been guilty of eating a pigling, ought not to be kept any longer, but fattened off. Various

explanations have been given of this unnatural crime. It has been attributed to temporary insanity, to jealousy on account of interference and inspection, to the infliction of pain by the teeth of the young pigs, and to disorder of the milk function. It is in order to prevent one of these causes that a high authority on pig-breeding recommended each little pig to be examined with a view to removing any prominent "wolf" tooth which might possibly irritate the sow; but, on the other hand, nothing upsets a sow more than to hear one of her offspring utter a cry of fear or distress. It is not advisable to feed brood sows with raw flesh, as the appetite for blood is easily induced. It is also certain that a sow that has once eaten one of her pigs is not to be trusted in the future, but is only too likely to eat another, and to continue the same vicious course with future litters.

**Management of Sows and their Young Pigs.**—As soon as the sow has farrowed, her diet should be improved. She is better in

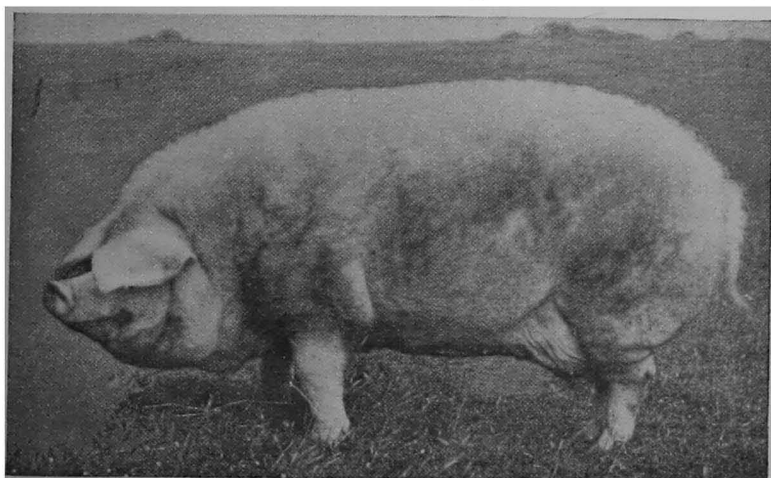

FIG. 138.—Lincolnshire Curly-coated Sow.

comparatively poor condition until she has pigged, but almost immediately afterwards she may be liberally fed with a thick wash, composed of water or separated milk, pollards, bran, and sharps. A large litter is a heavy tax upon a sow's strength, and for the first fortnight the little pigs almost entirely depend upon their mother. Barley meal is more fattening than milk-producing, and the above-named wheat-offals are particularly suitable for milk, and also as the first extra food for little pigs.

Pigs are almost always born in excellent condition as to flesh, and are muscular, bright, and pretty. They are very pugnacious, and fight over their teats the day they are born, exhibiting the arts of combatants in a manner which it is amusing to watch. A very few days after they are born they should be allowed access to a separate pen, and it is well to provide a double pen in case the farrowing sty is required for another sow. The little pigs may be allowed to pass through a hole in the wall, and be tempted to eat out of a small trough



placed in the adjoining enclosure. There they can receive milk mixed with sharps and pollards, as a thin wash. They are now full of activity and play, and a few dry peas may be scattered over the floor. They will also eat coal ashes, or even small bits of coal, with evident relish, and these act as a stomachic.

Young pigs should be kept scrupulously clean and dry, or their tails may drop off, which is disqualifying for show purposes. The writer has missed very small pigs where rats were abundant, and, considering the artfulness of these creatures, it may be well to guard against them.

The Reckling.—There is often one little reckling, Benjamin, or Bartholomew (Shakespeare mentions him under the latter name), which is undersized and weakly from the first. He develops hair, and looks scraggy and lean, but is capable of being reared if he is taken away from the rest and brought up by hand. Some labourer will probably offer a small price for him and take him home; and a few months afterwards he may surprise those who remember him as a baby. If by ill-chance a brood sow dies, her pigs may easily be brought up on the bottle, and show great intelligence and affection for their foster-parent. Warm cow milk may be used, and a narrow-spouted tin with an artificial teat attached will be found convenient for administering the food. They soon know their feeder, and will follow him about like so many dogs. I have fitted a barrel perforated with holes around, with a teat inserted in each hole, and the pigs soon learn to use their foster-mother.

Later Management.—By the time they are a month old pigs will have developed their omnivorous tastes, and will try anything offered to them. Sharps and pollards with mother's milk and a little milk from the dairy ought to be sufficient. Pigs are great grazers and soon learn to eat green food, such as trifolium and vetches, which they champ, but do not swallow. Brewers' grains and whey may also be made into a wash later, but until they are weaned at two months old they rely mostly on milk. Weaning is no great trial to well-managed pigs, as they have already become almost independent, and are by then growing into small stores.

Store Pigs.—As pigs are mostly farrowed either in early spring or late summer, they are naturally intended for different purposes. January pigs may be fattened by Christmas when about 10 months old. August pigs will be fit for stubbing after harvest, and are useful for running in straw yards with cattle during winter. Pigs grow according to the amount and character of their food, and if fairly well bred may increase in weight at the rate of 1 score of 20 lb. per month. Thus a 7 months old pig may yield a carcass of 7 scores, and this is the most esteemed weight on the market. Ten score pigs are too heavy, as the following current price list shows :—

		<i>Prices at Calne.</i>		<i>s. d.</i>	
6 sc.	10 lb. to	8 sc.	10 lb.	.	11 9 per score.
8 sc.	11 lb. to	9 sc.	10 lb.	.	11 3 " "
9 sc.	11 lb. to	10 sc.		.	11 0 " "
10 sc.	1 lb. to	10 sc.	10 lb.	.	10 9 " "

Pigs grow and fatten at the same time, and there is but little trade for big stores, which at one time were bought for fattening to carcasses of over 10 score.

**The Fecundity of Pigs.**—An animal which produces young at one year old, twice a year, and ten or twelve at a time, is capable of increasing in numbers with extraordinary rapidity. Calculations have been made demonstrating this fact on very moderate or reasonable data. One case worked out was that of a sow producing a litter of six at 1 year old, half of which were sows. She was assumed to have two litters a year of the same number and proportion of sow pigs, and to continue breeding till she was 3 years old. All the sows were to be kept for breeding with precisely the same results as to fertility, and the question propounded is—how many pigs would have descended from this sow in six years? The reader may find it interesting to answer this question.

The contrast between pigs and horses, cattle, or sheep, in the above respect is very striking, and easily accounts for the great fluctuations in the price of pigs. Pigs are subject to cycles of low and high prices, chiefly because of the rapidity with which they increase. When they are cheap farmers cease to breed them, and when there is a scarcity and prices go up, they reverse their policy, and the consequence is a perpetual see-saw of prices.

**Fattening Pigs.**—From what has been said it is evident that many pigs will not be more than 6 months old when they are put up to fatten. Seven scores at 7 months old, however, involves liberal treatment from birth, and in actual practice it is more probable that the top prices for carcasses of from  $6\frac{1}{2}$  to  $8\frac{1}{2}$  scores will be given for pigs of from 8 to 10 months old.

There are advantages in allowing time for the development of frame and muscle, for bone is required to carry flesh, and muscle is the anatomical expression for lean meat. Bacon may easily be over-fat, and a prolonged period, in which the pigs can grow, is a natural check upon this fault. At Limerick, where many thousands of pigs are slaughtered every week, the animals are not strikingly fat, and to the eyes of many English feeders might appear lean, and this argues a greater age, and a longer period of ordinary feeding. The principle generally acted upon is quick returns and fair profits, and when actual weight is the standard the degree of fatness becomes of less importance.

The quality of the meat is, however, a consideration which cannot be passed over, and the food employed exerts an undoubted effect upon both the texture and the flavour of pork and bacon. For example, bean meal gives a hard character to bacon, and oily foods cause the flesh to waste in cooking and produce an inferior quality of flesh. Barley meal stands out prominently as one of the most popular foods for fattening pigs, and when milk and potatoes are added perfection is practically reached. The albuminoid ratio of barley seems to be exactly suited for the digestive system of pigs, and the only objection to milk is its high price. Separated milk is, however, cheap, and may be obtained at butter factories for an almost nominal price (in one case known to the writer, at 1s. per churn of 16 gallons).

Pigs which have run at large for some months before being put up to fatten have probably been fed on brewers' grains, grass, green fodder, roots, beechmast, acorns, and thin wash, according to the time of year, and are taken up after stubbling and put on to good keep for finishing. They may be 9 months old, and ought to be ready for sale after six or eight weeks in the fattening pens. They sometimes feel the effect of change of diet, and after forest grazing have been known to sicken and die. The effect of bad lying also tells upon them, and for this reason store pigs ought not to lie on cold ground in forests, nor on hot manure in yards, or their lungs may become affected.

**Generality of Pig Fattening.**—Cottagers, miners, and private householders vie with farmers in fattening pigs, and on the whole beat them. They are able to bestow more individual attention, and take more trouble in warming food and watching daily progress. They appear to have arrived at sound conclusions as to the best staple foods, and talk of "a sack of barley meal" as a synonym for fattening. They sink a little bag of fenugreek seed in the wash, scatter a few pieces of coal about the floor, give a little green food at odd times, and do everything to make the pig comfortable. The contrast between this and ordinary farm management is striking, for the large farmer does not feed his own pigs, and the dairy- or cattle-man cannot spend much time over them. The pigs may be fed regularly and well, but there is a want of personal attention which tells against wholesale fattening. The cottager regards the process as eminently practical, and need not go far in search of the best food. Scientific rations are outside his knowledge, but he is already well instructed through the experience of others as to the virtues of barley meal, potatoes, and milk.

**Fattening Pigs on Farms.**—The rules observed in fattening pigs on farms are simple and sound, and may be enumerated as follows :—

1. The sty should not be too large, and consist of a comfortable den with an outside court, in which the troughs are placed.
2. Several pigs may occupy the same pen, but it is important that they should know each other intimately from the outset, or they will fight to the death.
3. Barrow, or hog pigs, should be kept together, and sows are better fattened separately, and alone.
4. A low lattice may be provided as a bed, and this will save litter and promote cleanliness, if frequently taken up, swept under, and the floor occasionally washed.
5. The pen should be well ventilated, and of comfortable temperature.
6. If the roof is of corrugated iron, it should be lined with straw on the inside.
7. A supply of clean water in a separate trough is desirable.

**Feeding Fattening Pigs.**—A sound system of feeding may be epitomized as follows : Store pigs should be fed twice a day, fattening pigs three times a day, and show pigs four times a day.

Store pigs should be fed on thin wash, but fattening pigs should have their food stiff so as to require stirring with a short stout stick. The nearer pigs approach ripeness, the firmer do they prefer their food; and show pigs are fond of moistened meal rolled into balls, with access to fresh clean water. Condiments are employed by many experienced feeders in small quantities. A little walking exercise is good for show pigs, but fattening pigs are better without it.

The feeding should be punctual, and naturally follows the order of morning, noon, and night. It is important that the pigs should clean up what is given them, and here the judgment of the feeder comes in. Too often troughs are to be seen half-full of victuals, upon which the fresh food is poured. This is bad management, for no animal likes stale food, neither is it good for them to be satiated or overdone. Here the cottager has an advantage over the farmer, for with a large number of pigs to be attended to individual attention is a very difficult matter. Still more difficult is it when the pigs only constitute a part of the dairyman's duty, and he has many other animals to look after.

**Food.**—Barley meal, potatoes, and separated milk have been recently recommended as staple foods for fattening pigs. Mr. Loudon M. Douglas in his paper on Swine Husbandry (Farmers Club, January, 1911) advocated 4 lb. of barley meal, 3 lb. of potatoes, and 1 gallon of separated milk as a paying ration, and one in common use. He added that "if given in three portions to each pig per day, starting from a weight of 80 lb. and gradually fattening the animal to bacon size, it will be equal to a gain of about 15 lb. weight per week". Mr. Douglas in the same paper submitted the following comparative scale of feeding values of various materials used for fattening pigs:—

	Points.
1. Barley meal, skimmed milk, and potatoes . . . . .	1,000
2. Barley meal and milk . . . . .	903
3. Maize meal and milk . . . . .	877
4. Maize meal and bean meal . . . . .	590
5. Barley meal . . . . .	519
6. Maize meal and pea meal . . . . .	489
7. Maize meal . . . . .	484
8. Barley meal and bran . . . . .	499
9. Maize meal and bran . . . . .	404

The same authority stated that "the heaviest weekly gains in weight in proportion to the food supplied occur at the earliest period of existence. As the animal grows, the weekly gain gradually diminishes, while the food necessary to the upkeep gradually increases". This is true in a general sense, but as regards fattening pigs it is a matter of observation that they eat less as they approach ripeness, which indeed is only to be expected. The increase of 15 lb. per week on the diet of milk, potatoes, and barley meal is not easy to calculate into dry matter, or to compare with results obtained from barley meal alone, as used by the late Sir John Lawes many years ago at Rothamsted. It was then found that fattening pigs

increased 20 lb. in weight for every 100 lb. of barley meal consumed, whereas according to Mr. Douglas' figures, and taking 10 lb. as the weight of a gallon of separated milk, his dietary weighed 17 lb. per day, or 119 lb. per week, resulting in an increase of 15 lb. or 12·7 per cent of food consumed. The results are less discordant than might at first sight appear, as to be strictly comparable both dietaries should be reduced to a dry standard. There can, however, be no doubt that a mixture of barley meal, potatoes, and separated milk is very superior to a porridge made of barley meal alone.

**Hints on Pig Management.**—When a pig is kept too warm it loses its coat, but exposure in an open yard soon restores it. This is important for show animals, for loss of hair is certainly a fault which will not escape the eyes of a judge. Young pigs are often put out of shape by eating out of too high troughs. They become upright at, and hollow behind, the shoulders.

Too heating a diet, such as beans, tends to make pigs rough or scurfy in the skin, but a few beans are a good change. Pigs are sometimes affected with lice, and when this is noticed it is a good plan to pour a little sweet oil along their backs, and the warmth of the body will cause it to spread and cover the entire skin. No insect parasites can stand oil, as it chokes up their breathing pores and destroys them.

A little sulphur is supposed to improve the appearance of the skin, and can be administered by mixing it with the wash. Pigs are awkward animals to drench, and, fortunately, they can be dosed through their food. If, however, it is necessary to use force, the best vehicle is an old boot with the toe cut off. This can be readily inserted in the mouth, and the medicine is then poured in and will pass down the gullet.

Acorns are much esteemed in Gloucestershire. In the New Forest beech-nuts and acorns are largely used by the verderers, under the name of rights of pannage. Acorns are thought by many farmers to be superior to beans for fattening pigs and to give a firm quality to the flesh; but may surfeit the animals and even prove injurious if given in too large quantities. Acorn-poisoning is well known in connexion with cattle under 2 years old; but the universal practice of pannage, dating back to Anglo-Saxon times, indicates that beech-mast and acorns have never been considered dangerous for pigs.

### JUDGING LIVE STOCK.

One of the difficulties to be encountered by every student of agriculture is that of judging stock, neither can efficiency be acquired without years of experience in the show or sale ring as the case may be. A farmer may claim to be able to distinguish a good from a bad sample of wheat, oats, or barley, but rarely is his judgment comparable with that of the corn merchant, who is continually handling samples, and whose eye becomes trained to the many differences which constitute condition and quality of grain.

Farm students should attend markets with some useful purpose in

view, namely, to train their powers of observation as regards the breed, form, weight, and value of such live stock as are offered for sale, and not merely to note prices, which may afford no indication whatsoever as to the state of the market. The beginner cannot do better than observe and follow the practices adopted by shrewd buyers. Take, for example, the case of a fat steer or fat barren cow; the prospective buyer views the animal from behind, and notes by feeling whether there is a firm covering of flesh over the pin bones and ribs, and over and under the loin. He grips the skin overlying the ribs and tests its quality and elasticity, both of which are indications as to the quality of the flesh, as well as of carcass weight. He runs his hand along the back to note the width of the chine, which should not be peaked or drop behind the shoulder. A front view of the animal will display the width of breast, chest, and neck. Handle the flank carefully and note its "feel" and thickness—the heavier the better. Next handle the "cod" or purse, or fore-udder of a heifer, as, if well developed, the animal has usually thriven, or is a good "doer", while fatness in these regions is a safe indication of fat in other parts of the body. The development of the thigh should be observed, as it enhances weight.

Most sale rings have a raised centre which throws up the animal and makes it appear bigger to the untrained eye than it really is. Store cattle are often penned in meadows, at spring or autumn sales, and when the ground is undulating very careful comparison must be made between animals standing in hollows or low-lying ground and those at a higher elevation.

The farmer is mostly concerned with the purchase of store cattle, and here good judgment stands him in good stead. It is not difficult for the trained eye to pick out two steers from a pen of, say, ten or a dozen, which are both alike as to size and quality. The beginner, however, lacks this power of observation and differentiation between beasts of like age, and therefore too often fails to secure the best value for his money.

The farmer must produce what the public demand. For example, if in the case of mutton, small joints with ample lean meat are in favour, then he must strive to produce them, provided of course that it pays him better than producing animals of heavier weight at a lower selling price per pound. In sheep just as many points are to be noted as in fat steers. There should be length of body, and good width apart, and shortness, of legs. A bright eye, clear nostrils, clean breach, and sound feet are indications of good health.

In lambs and fat sheep the "dock" is a good indication of condition, as is also the dent or nick in the centre of the back, between the hips and tail head; the scrag or base of the neck should also be wide. Width behind the shoulders and of the loin and hips is important, while the backbone must be well covered. In lambs the dock and purse should be handled. In judging sheep the fleece cannot be ignored; it should be clean, of good quality, and true to the breed represented, and the pelt should be bright, pink, and clear.

Pigs cannot be handled like horned stock, nor is it necessary. In marketing pigs, mistakes must never be made in sending them to

## 282 LIVE STOCK, FEEDING, AND ECONOMIC ZOOLOGY.

the market in a semi-store or half-fat condition. They should either be sold as stores from, say, 10 to 16 weeks old, as porkers of about 100 lb. weight, or as bacon hogs of 200 lb. weight. The butcher has no use for the pig which is neither pork nor bacon, and poor prices must necessarily result from such methods of marketing.

Some of the best pork and bacon pigs offered in the market are cross-bred. In any case the body should be long and symmetrical, the underline level, and not tucked up at the flank, and the loins wide. A well-finished pig will possess a clean glossy coat free from wrinkles, the hair being usually fine, although some of the rough-haired Berkshires make excellent pork. A short head usually indicates an excess of fat, which, when combined with a thick and heavy neck, is associated with second quality flesh. The fore-legs set wide apart usually indicate thickness through the heart, while the ribs must be well arched, or well sprung and deep, in the bacon hog.

Space does not permit of scales of points being given specially applicable to each class or breed of stock. Agricultural instructors would do well to construct guides for their students in the form of score cards, whereon the maximum number of points, viz. 100, can be apportioned as deemed most advisable; and if this were done the student would have some definite guide or system to work upon. As an example in the apportioning of points, we append a scale of those which may be reasonably observed in the case of a typical commercial bacon pig, regardless of pedigree or show animals.

	Points.
General appearance, symmetry, and breeding . . . . .	5
Action, free and clean with no sign of cramp . . . . .	5
Evenness of flesh with no sign of wrinkles . . . . .	5
Hair long, fine, straight, and plentiful . . . . .	4
Ankles and feet short, straight, and strong, without coarseness; pasterns short yet springy . . . . .	5
Legs straight, with clean hard bone . . . . .	2
Tail set on high, and not coarse, well twisted . . . . .	3
Hams broad, full, and meaty down to the hocks . . . . .	8
Quarters long, wide, and straight from hip to tail . . . . .	7
Flanks thick and deep . . . . .	7
Belly full and straight, with at least twelve well-placed teats, and showing even underline . . . . .	5
Loins broad and not drooping . . . . .	5
Ribs well sprung . . . . .	5
Back long, straight, and evenly covered with flesh . . . . .	7
Chest deep, with large girth around heart . . . . .	5
Shoulders oblique and not too thick and wide . . . . .	7
Neck medium length and muscular, but not coarse . . . . .	4
Jowl small and not too heavy . . . . .	3
Ears thin, wide apart at base, and fringed with fine hair . . . . .	3
Head light, medium, wide between ears and eyes . . . . .	5

All or any of these points are subject to variation, but what is most important is that the judge should have some means of scoring them. Whether judging cattle or crops, it is not possible to carry in the mind the merits of any particular animal or collection of plants without confusion, therefore judging on "points" is adopted as the best means of arriving at a satisfactory decision.

When two or more judges are acting in unity they usually agree in the first place upon the number of points to be awarded for each characteristic peculiar to the breed of animal under consideration.



## CHAPTER VI.

### FOODS AND FEEDING.

COMPARISONS between the merits of different foods, and their effects upon the animal body are two distinct subjects, although they must for many purposes be considered together. Especially is this true when animals are grown and fattened at the same time. Food is necessary as a fuel, and that in a very literal sense, for it is subjected to a process in which what are known as the products of combustion are given off. As in an ordinary fire of coals, oxygen is needed in large quantities, and want of air will extinguish it, so surely will absence of internal combustion and want of the necessary oxygen terminate life. The lungs are the bellows by which air reaches the blood, and by which oxygen is brought into contact with it through extremely fine membranes. True combustion takes place, heat is generated, carbonic acid and water are formed, and appear visibly in the breath. If any person breathes through a pipe into lime-water, the effect is to produce carbonate of lime as a white and cloudy precipitate, and the vapour of water appears at once when the breath is exhaled into a cool atmosphere. The amount of heat generated by the consumption of a given weight of combustible food—and all foods are combustible—is absolutely calculable as calorics, and becomes the measure of the value of the carbo-hydrates for feeding purposes.

*The carbo-hydrates* form a group in which each member is composed exclusively of carbon, oxygen, and hydrogen, and the two latter are always combined in the same proportions as in water. They are best illustrated by such familiar substances as sugar ( $C_6 H_{12} O_6$ ) or starch ( $C_6 H_{10} O_5$ ); and comprise various sugars, mucilages, pectin (the jelly of ripe fruits), gum, cellulose, and the resins. All of these, with the exception of the last, are highly nutritious, but their first function consists in keeping up the heat of the animal body. This is well known to be constant in health, and any increase or diminution in temperature betokens disease. It is maintained at the same degree in all climates from the Poles to the Equator, and in human beings is normal at 98.4 F., which is true blood heat. A large proportion of the food consumed is necessary for maintaining this constant temperature, and, as in an ordinary fire anything combustible will burn, so in the animal body other food materials beside the carbo-hydrates may be burnt up in order to supply heat. Heat is known to be readily converted into energy or force, and hence in the mechanism of the body muscular exertion is closely related to the amount of carbo-hydrates consumed in the food. Not only the warmth but the energy of the body depends upon food.

Besides the true carbo-hydrates, there is another group of closely allied substances known as oils and fats, which however differ in this respect—that the hydrogen and oxygen they contain are not united in the same proportions as in water. The oils and fats form a long series, including alcohols, ethers, and waxes. Oils and fats are highly nutritious, and are estimated to be 2.4 times richer than starch or sugar as fat-producers. The carbo-hydrates and fats are therefore justly regarded as fat-formers and heat-producers, and are used up in the production of muscular energy. It is therefore evident that in order to obtain the maximum amount of increase in weight there must be a minimum waste in keeping up the temperature of the body or expended in exercise, and hence fattening animals must be kept warm and quiet.

*Accumulation of fat in the animal body* is the result of an excess of carbo-hydrates and fats in the food, over the requirements of the body as to heat and motion. Fat is derived from these foods, and, so far as fatty foods are concerned, they pass with little change into the body; but as regards both classes they are elaborated and deposited as adipose tissue ready to be called upon in any emergency. Fat is reserve force, and no animal can starve to death while its body still retains a store of available fat. This is the secret of hibernation, and of the power of fat animals to withstand hunger. Fat is not exclusively due to the use of fatty and sugary foods nor yet of other members of the carbo-hydrate or hydro-carbon groups. It may result from albuminous foods, a group yet to be considered, but at greater expense, involving the burning up of protein which ought to be devoted to other objects. This is an important matter which must be considered later. We are at present dealing with classes of foods which only contain carbon, hydrogen, and oxygen, for their ashly ingredients, whatever they are, are less important from a nutritive point of view. These foods can only supply fatty tissues, and are incapable of producing nerve, muscle, tendons, cartilage, gelatine, bone, skin, hair, and connective tissue. The general frame of the body is one thing, the accumulation of fat is another. And yet the tissues of the body may be enlarged in bulk by deposits of fat. Muscles may be interlarded with fat, so that the mass of lean meat may be increased, and rendered more luscious and juicy, but not so the muscular fibres themselves. They are anatomical entities, as are all essential parts of the body.

Fat is scarcely an integral part of the frame, and in the most perfect conditions of athleticism it is reduced to a minimum. So it is in race-horses, but in fat cattle and sheep its development is encouraged. In wild animals it is subservient to muscle, but in domesticated animals it accumulates in lumps and patches, sometimes to an extravagant degree. Fattening, as a process, is properly defined as the accumulation of fat in the animal body, and is best attained after the animal has done growing. In our system of fattening from birth it is simultaneous with growth, and hence fatty and sugary or starchy foods must be assisted by albuminous foods.

*Waste in the body.*—Whether adult or growing, the body is subject to perpetual waste which has to be replaced, so that even fully matured

animals require foods of an albuminous character. Just as the lungs discharge carbon and watery vapour, so the kidneys excrete the effete matter of the muscles, nerves, and bones. The body is in a perpetual state of flux or change, and probably the entire fabric is dissolved and restored during every few weeks. Some of the harder parts are more resistant than the softer tissues, but the drain of phosphates through the urine indicates that even bony tissues are subject to waste and renewal. These facts bear upon the maintenance and fattening of cattle, for while the weight of the body is increasing under a regimen of fattening foods, the brain, the nerves, the bones, and all other tissues require to be kept up.

*The Proteins or Albuminoids* are justly looked upon as of the highest importance, for they are more vital than the hydrocarbons and fats. They can in fact supply their place, but no amount of sugar or fat can replace protein. Besides, to convert albuminoids into fat is wasteful, as they are always much more expensive to buy than amylaceous or farinaceous foods. It has been held that the manurial value of proteins is so great as to compensate feeders for their high price, but this is unsound economically. To purchase protein in the form of food expressly for the purpose of manuring the ground is an expensive process. It is also slow, for time is necessary before farm-yard manure can be utilized, and still more so before it can be realized; and nitrate of soda would probably be found to be both cheaper and quicker in its action. The proteins should be regarded as food rather than as manure, although it need not be doubted that they are of great value in the latter respect.

They are of greatest value when supplied to growing animals, and the proportion in which they exist in a food may be much reduced for fully grown steers or sheep. The subject of albuminoid ratios has already been touched upon, but the highest ratio of protein to carbohydrates and fats should be reserved for young animals, or, for what is a very similar case, pregnant, and milk-giving animals.

*Sources of Albuminoids.*—Protein occurs in all animal and vegetable bodies, and is a characteristic ingredient of albumen or white of egg, from which the group derives its name. It is represented by casein, blood-fibrine, and gluten. It is found in all tissues where nitrogen forms an integral part of the structure, and always contains sulphur and phosphorus. Casein contains 53 per cent of carbon, 7 per cent of hydrogen, 15.65 per cent of nitrogen, 0.72 per cent of sulphur, .85 of phosphorus, and 22.78 of oxygen; and this may be taken as a type of the general composition of protein. The peculiar ingredient is nitrogen, hence proteins are spoken of as nitrogenous, and also as flesh-forming, in contradistinction to fat-formers. They occur in all animals in the brain, nerves, blood, and muscular fibre, and in the seeds and other parts of plants, as for example in wheat, linseed, and cotton seed, and what are known as "cakes". They are liable to be confused with other nitrogenous substances of similar composition, but of lower value, such as the *amides* which are transitional in their nature, and occur in immature vegetable tissues. Gelatine is not now classed with the proteins as a nutrient, as its nourishing properties are uncertain and have probably been overrated.

It is the material to which animal jellies, such as are derived from calves' feet, owe their gelatinous properties.

The above two groups of non-nitrogenous and nitrogenous nutrients practically occupy the entire field of foodstuffs, and it is by the varying proportions in which they exist that they are valued.

*Water in foods.*—Water occurs in all foods, but has no commercial value. All analytical results, unless otherwise specified, are calculated upon dry matter, in which the water has been driven off at a temperature of 212° F. Although water possesses no chemical value it is highly important physiologically, and its intimate incorporation with vegetable tissues, as in fruits, roots, grass, etc., confers a luscious and attractive character upon them. It does not, in fact, exist in them as pure water, but as solutions and cell-contents, or as sap and juice which form an integral part of the living organism. Such water is free from deleterious compounds in healthy and wholesome vegetables, and often supplies the place of water. Succulent vegetables support animal life without the help of any exterior water supply, and the moisture is so blended with the food that it is not taken in excess (see Grass and Roots). It is also in many cases above the temperature of spring and well water, and a diet of green fodder, in which further additions of drinking water are not necessary, is considered wholesome.

To state that the water contained in grass or turnips is exactly on a footing with water from a pond or pump is an evident mistake, as in healthy growths it contains no germs of disease, no poisonous or injurious matter, and is exactly proportional to the wants of the animal. It also renders many foods palatable and attractive, as for example milk, fresh fruits, and juicy roots, or grass, and its importance is shown by the superior quality of dairy produce and beef derived from fresh grass over the same products derived from hay. Nevertheless, water is not assigned any value by analysts, and its presence detracts from the nutrient value of a food in assessing its comparative value.

*Mineral matter in foods.*—The ash of plants contains all the mineral constituents of the blood of animals, and is generally sufficient to supply what is necessary.

The phosphorus and lime of the bones, the fluorine of the teeth, the iron of the blood, the potash in wool, and other mineral ingredients are supplied in the food with little exception. It is true that salt, iron, and phosphates are given medicinally, but in Nature animals depend for their mineral matter upon their food. Salt-licks are an exception, and are resorted to by wild animals, and earthy matter is partaken of by birds and some mammals, but these exceptions rather prove the rule as to the formation of the blood and skeleton from vegetable matter. Even in the case of the Carnivora their food is originally derived from vegetables. The mineral matter in food possesses a residual manurial value, as it keeps up the supply of phosphates and salts in the urine, and the manurial value of bones is traceable to the grass of the field.

*Grass as a Food.*—Grass is properly considered to be a perfect food for ruminants. It is impossible to improve upon it, although it

## 288 LIVE STOCK, FEEDING, AND ECONOMIC ZOOLOGY.

may be supplemented, when it is deficient in either quantity or quality. Grass is found in perfection on good land in the spring and early summer, and possesses its highest nutrient value when it is young. In three cases cited by Warrington the decline in feeding properties in grass from May to the end of June are shown as follows (calculated dry):—

### NITROGENOUS SUBSTANCES.

Date of Cutting.	Albuminoids.	Amides.	Fat.	Soluble Carbo-hydrates.	Fibre.	Ash.
May 14	11.5	6.2	3.2	40.8	23.0	15.3 = 100
June 9	9.4	1.8	2.7	43.2	34.9	8.0 = 100
June 26	7.8	0.7	2.7	43.3	38.2	7.3 = 100

The progressive decline in albuminoids, and the rise in fibre are remarkable, and fully explain why young grass is better than old. Experience bears out analysis, as all graziers appreciate the value of young grass and the hay made from it, while all hay-makers know that young grass is "fiery" when put into rick prematurely, i.e. liable to overheat owing to its richness.

*The value of grass as a food* is shown by the colour and flavour of milk when cows are out at grass, and also by the high quality of the butter and cheese made from it. It is also remarkable that "hay cheese" is distinctly inferior to "grass cheese", although the hay and grass may both have been produced on the same land. The only difference between the two, besides loss of water in drying, is age, for grass is young when grazed, whereas hay is often old when cut. The inferiority of winter dairy goods is not easy to explain, but may be attributed (1) to the age of the hay when cut, (2) to the introduction of other foods such as turnips and straw, (3) to want of freedom or exercise. It may also be partly due to the cows being old in milk.

The watery character of young grass is a feature which should not be passed by unnoticed. Average grass contains 75 per cent. and hay 14 per cent of water. Young grass is more succulent, and therefore more watery than old grass, which is becoming fibrous in character, and there is also a migration of albuminoids and starch towards the seed-vessels. The juiciness of young grass is therefore one of its recommendations. It is full of sap, and its cellulose is in a digestible condition. The nutrient matter is distributed through the leaves and stems, and the latter have not yet developed into bents.

*The nutrient value of different species of grasses.*—Much has been written upon the superiority and inferiority of different grasses, and tables have been constructed showing the difference. There is no doubt as to the greater nutrient value of some species over others, but, at the same time, it is extremely difficult to arrive at any definite conclusion as to the relative merits of most of them. The land on which they are grown affects their feeding qualities to such a degree that inferior grasses, such as Yorkshire fog, may yield better pasturage and hay on some soils than superior grasses do on others. The stage of development is another factor, for inferior grasses may be more nutritious when young than superior grasses are when old.

It is for these reasons that we have refrained from publishing analyses of the various grasses, and there is yet another reason for this course, namely, that almost all pastures are composed of a great variety, not only of grasses, but of other forms of herbage.

*Mixed character of pastures.*—The number of species which may be found in any pasture is very large, and also very various, according to situation; and in many parts of Switzerland pastures are almost entirely made up of herbs. Taking a list of “weeds” as a guide, it will be found that a large number of them occur in ordinary grass fields, besides the usual grasses and clovers selected for sowing in mixtures. As the miscellaneous character of natural herbage has important bearings on its properties as food, we append a list of some of the plants which may be found in any pasture, and certainly in pastures as a whole.

## LIST OF SOME OF THE PLANTS PRESENT IN MOST PASTURES.

Meadow rue	Sow-thistle	Gentians	Mallow
Buttercup	Goatsbeard	Quaking-grass	Crane's bill
Ladies' smock	Harebell	Bents ( <i>Agrostis</i> )	Rest harrow
Ragged Robin	Heath	Soft brome grass	Ladies' mantle
Mouse-ear chickweed	Ling	Tussock grass	Burnet
Stitchwort	Cowslip	Yorkshire fog	Fools' parsley
Hogweed	Bed-straw	Dandelion	Daisy
Chamomile	Yarrow	Ragwort	Knapweed
Wetted thistle	Pimpernel	Meadow-sweet	Common rush
Plum thistle	Centaur	Common dock	Wood rush
March plum thistle	Eye-bright	Sorrel	Plantain
Hawkweed	Yellow rattle	Meadow saffron	Bracken
Horse-tail	Goose-grass	Mosses	Forget-me-not

*Occult properties of pastures.*—The great diversity of the herbage which composes pastures, the different character of the soils on which they rest, their altitude, their relation to moisture, and to climate, as well as to seasons, form very complicated subjects of inquiry. All of these considerations come in when we attempt to study “grass” as a food. Its effect upon dairy produce has already been alluded to, but no more seriously than it deserves. The peculiar nature of cheese is often due to pasturage, and some of the best cheese pastures are rushy and marshy in character. The curd produced in spring is stronger than that made from fall grass, and less liable to heave. The quality of beef and mutton is also affected by the herbage on which the animals graze, and the flavour of the flesh by the presence of certain plants, such as heather.

As to injurious herbage, some pastures are notorious for producing red-water, abortion, or liver-rot, owing to the presence of meadow saffron, ergotized grasses, or the germs of the liver fluke. Some of the effects of pasturage are very obscure, and for this reason are spoken of as occult or mysterious. They are, however, sometimes explainable and removable by drainage or applications of lime, salt, etc. The tendency of liberal management is to simplify the character of herbage by reducing the number of species; for many weeds die out under the influence of fertilizers, and are supplanted by

## 290 LIVE STOCK, FEEDING, AND ECONOMIC ZOOLOGY.

desirable grasses. Undesirable species are best attacked by the use of artificial foods and manures, rather than by direct attempts at eradication. One point, however, deserves special attention, namely, the great variety in feeding materials which pastures afford.

*Selective instincts of animals with regard to herbage.*—No one can observe animals on grass land without being struck by their exercise of choice with regard to victuals. Cows will await their transference from one pasture to another, and hang about gateways until the time comes. They hastily pass over some herbage, and concentrate on other parts. They bite certain portions close to the ground, and leave others neglected. The same partialities may be observed in sheep, and are evidently the result of instinct.

All animals choose their food with an evident object, and the freer they are the better do they attain it. Hence open grazing usually gives better results than close-folding. Wild animals exhibit these instincts in still greater perfection, for they select suitable foods for their young as well as for themselves.

One result is their perfect muscular development and their splendid condition as to training. They develop peculiarities of flavour and texture of flesh which are scarcely looked for in domesticated animals, such as the taste of heather in grouse and black-faced sheep, the rich colour and gravy of mountain-fed mutton, and the superiority of grass-fed beef. These facts are rendered more apparent when contrasted with the results of stall or winter feeding. Here also food gives flavour to the meat, as is found in the taste of turnipy flesh, and the soft oily fat produced by cake feeding. The butter is pale and flavourless, the cream colourless, and the milk thin. There is no abounding choice of food, and the hay, although consisting of many species of plants, must be made from comparatively old herbage.

The artificial systems of feeding are both simple and same. The food consists of swedes or mangel-wurzel, straw chaff, meal, and cake, often mixed together in a heap and given at stated intervals. If the animals are watched they will be seen to exhibit a good deal of impatience, turning the mixture about with their noses and throwing some of it out of the manger. They examine it and seek out the parts they like best, but the choice is limited, and they must put up with what is given them. It is, however, found advisable to give one particular food in unlimited quantity, such as oat straw or hay, and from this they always cull the best and waste the rest.

*A lesson in feeding.*—The above facts teach a lesson which it would be well to study. It may possibly be a mistake to mix many foods together, and it might be better to ascertain by observation what the cattle really prefer. It is not unlikely that the value of condimental foods, which has never been appreciated by agricultural chemists, may consist in their aromatic flavours and odours, derived from the familiar herbs and seeds from which they are compounded. The flavour of fresh leaves varies in a most striking manner, and many of the herbs mentioned in the above list of pasture weeds may possess virtues not revealed by analysis. Among these may be mentioned

fool's parsley, chamomile, yarrow, eye-bright, meadow-sweet, sorrel, dock, gentian, mallow, crane's-bill (geranium), rue, wild thyme, and pimpernel. Some of these are included in condimental foods, as are carraway, wormwood, fennel, fenugreek, gentian, ginger, hop, mint, juniper, marjoram, sage, etc. How far other aromatic plants could be introduced into condiments it is impossible to say, but most of them, and many others beside, are open to cattle and sheep browsing at large. It is not here contended that the usual system of winter feeding is wrong; but it might be modified by the introduction of "mixed herbs", prepared separately and mixed with the less tasty foods. Condimental foods lie under a scientific ban, but spices are esteemed by many feeders, and many possess appetizing, digestive, and stimulating effects, which would be beneficial to fattening animals in general.

*Mixing foods for cattle.*—There are advantages in giving foods separately, as it affords changes and relishes. A feed of meal and hay chaff first thing in the morning may be followed by sliced swedes at 9 and crushed cake at noon. Meal and chaff may again be given at 2 and 4, and a feed of long hay at 8 o'clock at night. The promiscuous mixing of meal, chaff, pulped roots, and cake in moistened condition is liable to produce waste, as the animals rummage the contents of their troughs in order to find the titbits. The food is also liable to become fusty or sour.

*Roots as Food.*—Cruciferous roots possess the pungent properties of their natural order. Although they contain some 90 per cent of water their solid matter is sweet, and is all digestible to live stock. Roots are not adapted for exclusive use, but are particularly suitable for feeding with straw, hay, and dry fodder. Turnips and straw are complementary to one another, and are an accepted dietary for dry cows and young stock. They also form a basis for fattening foods, as they can easily be enriched by additions of meal and cake. Turnips have been objected to as "watery", but this only applies when they are given in excessive quantities; and in warm weather their succulence becomes a point in their favour. They may be used in small or in large quantities, according to the system of feeding employed, or may be dispensed with altogether, if necessary. They are a cheap food in districts where heavy crops are produced, but are liable to fail in dry seasons.

Roots are looked upon as the basis of winter feeding; and their success or failure controls the prices of lean stock more than anything else. The ability of a farm to support winter stock depends upon the supply of roots, and the abundance of the next year's corn crop is closely connected with their success.

In spite of all that has been written upon the watery nature of roots, they still maintain their position as a principal food for stock.

*Straw as Food.*—Straw has always been a recognized food for oxen from Biblical times. It is less nutritious than hay, because it is cut later, but when it is cut green, as in the case of oat hay or green maize, it may be equal or superior to it. The following table shows the composition of the cereal straws, oat hay, grass, and clover hay.



NUTRIENT CONSTITUENTS OF VARIOUS KINDS OF STRAW.

Kind of Straw.	Water.	Albuminoids and Amides.	Fat.	Soluble Carbo- hydratee.	Ash.	Indige-tible Fibre, etc.
Wheat straw . . .	14.5	3.0	0.4	32.9	4.5	per cent. 44.7
Barley straw . . .	14.2	4.0	0.4	36.4	4.2	40.8
Oat straw . . .	14.0	3.5	1.4	37.6	4.0	39.5
Oat hay . . .	15.0	10.2	0.8	40.2	6.2	27.6

The precise composition of straw varies with the stage at which the crops are severed, and upon the character of the soil and season; but the above figures give a fair idea, both as to the actual and relative analysis of each kind of fodder. Wheat straw is too hard, and also too valuable to be used as fodder. Barley straw is softer and more easily eaten; and in many cases it contains a little clover, which improves it as food. Oat straw is the most valuable, and if early cut and well-harvested spring oat straw may easily be superior to inferior hay. Straw may be given long, in racks, or cut up into chaff, and mixed with concentrated foods. It may also be steamed or scalded as chaff, and rendered palatable by additions of linsced mucilage, treacle, or oil; or cut up with hay. All of these methods are in use, but straw is perhaps at its best when given as dry chaff mixed with meal. Steaming is thought by many experienced feeders to entail trouble and expense without any advantage; but mucilage or syrup poured over a couch of chaff, and given before it turns fusty, is a means of inducing cattle to eat a larger quantity of straw than when it is presented in the long state.

Chaff and Cavings are much used for live stock. They are ready to hand without any process of cutting into lengths, and wheat and oat chaff are richer in albuminoids than the straw from which they are derived. All chaffs contain 9 or 10 per cent of ash, but this does not interfere with their consumption. Wheat chaff is popularly known as dust, and a "dust-bin" is to be seen in most work-horse stables. It is mixed with the corn, on riddles, before placing it in the manger, and is much liked by the horses. Oat chaff is a valuable food and is also often used to stuff beds and bolsters, but it is light, and liable to become fixed on the eyes of cattle, and to form a chaff boil or "caff-bile", which causes severe inflammation and requires to be removed.<sup>1</sup> Barley chaff is composed entirely of awns, for the true chaff is adherent to the grain. It may be scalded and mixed with meal as a mash for cattle. Barley awns are, however, uncomfortable to handle, as they creep up sleeves and under clothing, to the discomfort of the wearers. Wheat chaff must therefore be considered as the best of the three sorts for fodder.

All chaff is liable to abound in seeds of weeds, and especially of docks, and for this reason alone ought to be used with caution, and when it is foul it is better burned.

<sup>1</sup> A little scraped cattle-fish bone, placed in a quill and blown into the eye, will dislodge oat chaff from the eye.

**Haulm.**—Bean, pea, and vetch haulm are all useful fodders, being pleasant to the taste and rich in protein. It is, however, necessary that they should be well harvested, and not have been exposed to much rain. Bean straw was made the basis of a system of cow-feeding advocated by a Mr. Huxtable many years ago, in which the haulm was chaffed and scalded. Pea straw is a favourite fodder for sheep in the Northern counties, where hay is less used than in the South; and vetch haulm is carted into yards, and thrown into racks for young stock. The peculiarity of all these haulms is their highly nitrogenous character. Bean straw contains 10 per cent, pea straw 6·5 per cent, and vetch straw 7·5 per cent of albuminoids, or from twice to thrice as much as the cereal straws.

**Hay.**—It is unnecessary to enlarge upon the importance of hay as a food for stock. It is frequently sold off the premises, and if of good quality possesses a much higher market value than it does as fodder. In the North of England it is almost entirely devoted to horses, but in the South it is very largely used for cows, sheep, and cattle. The larger proportion of meadow land in the Southern counties is one reason why it is so generally used. Hay is of many kinds, as for example water-meadow hay, which although inferior in quality, is largely used for cow-feeding; meadow hay, which varies in quality with its source; red-clover hay, which is of high value and always commands a good price when well made; trefoil hay, mixed hay, sainfoin hay, aftermath hay, and old hay. All these hays differ in character; the grassy and benty qualities being suitable for horses, while clovers and sainfoin yielding hay rich in albuminoids are admirably adapted for sheep. The difference in composition is shown in the subjoined list.

NUTRIENT CONSTITUENTS PER CENT IN VARIOUS KINDS OF HAY.

Kinds of Hay.	Water.	Albuminoids and Amides.	Hydro-carbons.			Indigestible Fibre, etc.
			Fat.	Soluble.	Ash.	
Meadow hay . .	15·6	13·5	1·2	43·1	6·7	19·6
Red clover hay .	15·0	14·2	3·1	37·2	5·7	24·8
Trefoil hay . .	16·7	14·6	3·3	33·2	6·0	26·2
Mixed hay . .	15·0	9·4	2·6	38·8	5·7	28·5
Italian ryegrass hay	14·2	11·2	1·4	41·4	7·8	24·0

These analyses must not be looked upon as absolute, but rather as approximate and representative.

**Green Fodder** differs from hay chiefly in being juicy and succulent. It may be young, while hay may have been cut after the herbage has passed its best. This is an important point, for, like grass, green food is always most nutritious when young. Thus, growing vetches, trifolium, rye, and clover are superior to the same plants after flowering. They then become hard on account of much of the cellular matter changing into woody fibre.

Especially is young stuff suitable for lambs, but older sheep will do well on vetches in pod, and horses prefer rye after it has shot into ear. The practical difficulty is to know when to begin feeding off these crops, as, if they are consumed too soon, they have not achieved their growth, and if too late they have become tough and "sticky", i.e. resemble sticks.

Cut green fodder is used for soiling in yards or in stables. Green crops also supply the flock with food from April to November, just as roots do in winter.

**Comparison between Green Food and Cake.**—Green food, whether in the form of grass or fodder, is capable of nourishing cattle and sheep without the assistance of cake or corn. It can maintain the flow of milk, or fatten animals, and contains all the food ingredients already mentioned. They are, it is true, in less concentrated form than cakes or corn, but before these last can be digested they require to be diluted. They are thus watered down to something like the same degree of strength as green food, and it is an error to contrast dry cake with fresh grass as a food, because the latter has to be greatly reduced in strength by additions of water before it passes through the intestines.

Good linseed cake contains 72 per cent of starch equivalent<sup>1</sup> (Kellner) and grass from rich pastures 13·1 per cent; but the grass holds 78·2 per cent of water, while the cake contains only 11. Hence, if the cake be diluted in the digestive system it must be reduced at least in the above proportion.

It will be seen that 72 divided by 6 equals 12, so that the diluted cake may be very little richer (if any) than good grass. The system of feeding cattle with linseed cake when on good grass is therefore unnecessary, and can only be defended when grass is deficient in quantity, or is losing its nutritive qualities. Similarly, nothing can equal grass for milk, and it is doubtful policy to give cake to cows in the height of the grazing season. Similar calculations as to the nutrient value of turnips and linseed cake give rather surprising results. Thus, swedes are credited by Kellner with a starch equivalent of 7·5, as against 72 in linseed cake. But swedes contain 88 per cent of water, or eight times as much as linseed cake; and to bring the two into agreement, as they must be when passing through the intestines, they should be reduced either by dividing the starch equivalent in the cake by 8, or multiplying the starch equivalent in the swedes by the same figure. The starch equivalent of linseed cake in the digestive system in comparison with grass is therefore 9 : 7·5, and not 72 : 7·5.

**Potatoes as a Food for Stock.**—Some of the coarser varieties of potatoes have been grown for stock, but they do not appear in many modern lists. Potatoes are very good for pigs, and may be introduced into dietaries for cows. Those used are either the small "pig potatoes", or diseased and rejected tubers. They are better boiled or steamed, partly because small potatoes are liable to stick in the gullets of cattle and choke them, and also because they are drier

<sup>1</sup> That is, the amount by weight of digestible starch to which its constituents are equivalent.

and in other respects better cooked than raw. Diseased tubers may be safely given to cows after steaming, and they greatly relish them.

**Dietaries.**—1. All dietaries are composed of some one or more of the above-named feeding materials, with the exception of grass, which, however, consists of many ingredients. To feed entirely upon turnips is a mistake—they are too watery; and to feed only on straw is wrong, as it is too poor and fibrous. Too much cake and concentrated food is bad, as it surfeits, and is wanting in that bulk which is necessary to fill the paunch of ruminants. An excess of albuminoids is not only economically wasteful but positively harmful, as it produces stiffness in the joints and other ailments, which are described as “albuminoid poisoning”. Grass is a perfect food, but fails during winter, and loses its nutrient properties towards the close of the grazing period. It also varies enormously in quality with the land which produces it.

2. Another feature of dietaries is that they must be adapted for various species of animals. Ruminants must have bulky foods for the proper exercise of the ruminating function (Fig. 92). Horses have small stomachs, which are liable to impaction. Pigs are omnivorous, and are adapted for more concentrated foods than cattle, sheep, or horses. They will not eat hay or straw, and husky foods such as cotton cake soon kill them.

These facts are well known to practical stock-keepers, and the diet specially suitable for each class of farm animal is pretty well understood.

3. A more puzzling matter in connexion with dietaries is the effect of one food upon another, which is sometimes antagonistic and sometimes beneficial. Thus, the effect of albuminoids is heightened when they are combined with carbo-hydrates, and a due admixture of each increases the effect of both. Sugar assists the action of starch, but too high an albuminoid ratio induces the combustion and splitting up of the nitrogenous elements, and the discharge of uric acid from the system through the kidneys. The mutual reactions of different foods upon each other are so varied, and so little understood, that it is scarcely desirable to enlarge upon them. They are “hard reading” in scientific works on feeding, and the enormous differences in opinion among medical men as to human dietaries further illustrates the difficulty of the subject.

4. *Age and condition* are also important considerations in arranging dietaries. Young, growing animals require a different regimen to adults; and pregnant and milking animals in many respects resemble young ones, as they must supply bone and other tissues to a fetus, or ingredients of the same nature to their offspring as milk. Cows are generally liable to a heavy drain for both these objects at the same time, and therefore require a large percentage of albuminoids in their food. Working cattle, whether horses or oxen, are subject to much waste of energy, and this bears upon the suitability of their foods. Thus straw may do well for cattle, and even for horses at rest, but it is too innutritious for horses at work. The nutrient value of straw is considerable, but the internal energy required to digest

it detracts from the available muscular force, so that straw becomes unsuitable for active horses.

Another complication arises out of the different digestive systems of farm animals. It is not enough to consult tables of analyses as to the comparative nutrient value of foods. Hay, for example, possesses a higher nutrient coefficient for sheep than for horses, and straw is more nutritious for bovine than for equine animals. Uncorticated cotton cake is wholesome for mature cattle and sheep, but is fatal for calves and lambs. Bulky and watery foods suit cattle, but are not so good for horses, nor yet for fattening pigs.

5. *The nutritive properties of all foods varies within rather wide limits.*—The tables of analysis supplied in books of reference fail to show the great differences due to the circumstances under which foods are produced. It is well known that the feeding properties of grass and hay differ enormously, and it is the same with roots and straw, and to a certain degree with oats and barley. It is partly due to the land on which they grew, but large and overgrown roots, old grass, skinny oats, and husky barley cannot be compared with moderate-sized roots, young grass, and plump well-filled corn. We may be mistaken in our high estimation of our home-grown foods, but no experienced feeder doubts for a moment that English barley meal is quite a different and superior article to husky stuff made from light foreign barley. The "prejudice" is reflected in market prices, for English barley, oats, and beans generally command a higher price than their foreign rivals.

6. *Importance of flavour.*—No diet can be of value which is not liked by the animals that partake of it. Flavour is probably of greater importance than is generally thought, although it is at once allowed that the animal should enjoy his food. It certainly is important to us, and even a thought, or fancy to the contrary will often be followed by abdominal pains and diarrhoea.

Flavour and attractiveness act on the salivary glands and promote digestion. An experienced butcher and grazier once suddenly said to the present writer when a boy, "How would you like to eat off a dirty plate?" It was a very apt question under the circumstances in which it was put, and was never forgotten. It bears not only on the food, but on how it is given. Any mustiness, sourness, staleness, or filth must detract very seriously from a food's value as indicated by analysis.

7. *Fluctuations in market prices.*—A large number of the foods placed on the market are fairly equal in respect of nutrient properties. It is often difficult to say whether this or that particular food is the better, but there are times in which cake is exceptionally dear, and home-grown corn is cheap; in which hay is decidedly a dear food, or it may be a cheap one. The successful farmer will be guided to a great extent by market prices, and, on the whole, definite cheapness of a certain approved food is a safer criterion than a tabular statement as to comparative analytical merits.

*Conclusion as to the choice of foods.*—All foods should be palatable, and fresh or "sweet". Among the best are home-grown green crops, roots, grass, hay, straw, corn, and pulse. Of purchased foods, the

recognized cakes, namely, linseed, cotton, palm-nut, etc. ; among meals, rice, maize-germ, barley, malt-dust (culms), and maize (whole or ground) ; among other foods, brewers' grains, locust-beans, linseed, molasses, soya beans, milk substitutes, etc.

The foregoing list of foods is by no means exhaustive, for every season brings up some new claimant for public favour. It now remains for us to consider dietaries, and in doing so we shall to a great extent follow practice. It is curious to notice how the prescriptions used by experienced feeders tally with the recommendations of science. This, indeed, is a great relief to anxious inquirers who may be puzzled by the complications of starch equivalents, digestive coefficients, albuminoid ratios, digestible and non-digestible protein, crude and digestible fibre, etc.

Fortunately the results of good feeding are exemplified in every show-yard and fat stock exhibition, and in a certain sense we appear to have arrived at perfection. The materials used are generally few in number, and their names are familiar to the ear, although specialities abound in the form of compounded foods. Many of these are excellent, although *compound cakes* have been condemned as less reliable than those made from one seed. Oil is not always derived from the best source, and it is satisfactory to know exactly what we are using. Besides, compounded foods are capable of being varied in order to leave a profit, by the substitution of cheap materials. Genuine linseed cake usually commands greater attention than any compound cake, but at the same time a dairy cake or a lamb food may possess superior qualities and become famous.

It would be invidious to name the best-known manufacturers of cattle foods, calf meals, lamb foods, compound cakes, etc., but they constantly appear in connexion with prize cattle ; and in the keen competition for show-yard honours they are constantly being tried by feeders.

As already stated, the principal foods are few in number, and it is also noticeable that stockmen pin their faith to some of them to the exclusion of others, but invariably insist upon having the best of the sort they fancy.

In discussing dietaries, the simplest plan is to take them as they are commonly used, and afterwards to inquire whether they are capable of improvement.

*Straw* is the simplest food available, and if well saved, fresh, and cut young it is a good mainstay. It is better when newly thrashed, and oat or barley straw with a little clover interspersed among it is quite capable of keeping dry cows in condition. Straw is also the basis of dietaries for store stock of all kinds, and is easily supplemented with 2 to 3 lb. of cotton cake and a supply of good water.

*Hay and straw*, together, supply everything necessary for store cattle. They may be given long and separately, or chaffed and mixed together.

*Straw and roots*, or hay, straw, and roots, leave nothing to be desired unless it is for fattening animals. It is difficult to construct any better or cheaper mixture. "Turnips and straw" are chiefly relied upon by the cattle-feeders in Scotland ; and in Aberdeenshire

cattle are known to have been fattened on nothing else, much to the surprise and the expressed doubts of Smithfield salesmen.

Turnips include swedes in the phraseology of the North, where they are both familiarly spoken of as "neaps"; and are sappier, heavier, and richer than they are in the South. So also the straw is less "bruckly" or brittle, and makes better fodder than when ripened under a scorching sun. The consequence is that bullocks may be fattened on Swedish turnips and straw in Aberdeenshire, with a little cake to finish them.

Sliced swedes placed in long troughs, and oat straw thrown into racks or hecks are thought good enough for store cattle, which improve in condition and become half-fat upon them.

**Enriching Straw.**—In order to enrich straw it should be cut up into chaff, which may be blended with hay. Meal is then added, as "meal and chaff", to be either given dry or moistened. The former plan is here recommended because it makes a change, the importance of which has already been insisted upon. The enriching of chaff may be carried to any desired extent by adding 1, 2, 3, 4, or more pounds per head of barley meal, bean, or other meals. Treacle, cod-liver oil, or linseed mucilage may also be introduced, and well mixed with shovels upon a floor; and a little water baled over and mixed by turning the heap, will cause the entire mass to gently heat. It is, however, desirable to mix what is required the evening before it is wanted, as it soon becomes sour or fusty. When fresh it is a savoury mess and is greedily eaten from the mangers. Molasses steamers (*v. p.* 391) may also be used. Dry meal and chaff is suitable for a morning meal, to be followed by cut swedes, dry cake, and more meal and chaff; the moistened food being well adapted for an evening meal. These directions are not meant to be too rigidly followed, but are given in order to indicate a system of feeding and a succession of foods. A rack filled with sweet oat straw is always appreciated by cattle, and serves to keep them employed and contented.

**Dietaries for Fattening Cattle.**—These have already been considered, and it is unnecessary to enter more fully into the endless variety of foods and proportions of foods employed in the fattening of cattle. They may consist largely of roots, but it is possible to fatten bullocks without them. Twenty pounds per day of roots was the amount given at the Royal Agricultural College, Cirencester, as far back as 1860, just enough to moisten the chaff, and give it a flavour. A bushel of cut roots is more usual, and this will be found to weigh from 35 to 40 lb. Two bushels, given at twice, morning and evening, is not too much; but the method of giving roots *ad libitum* is confined to the North of England and Scotland, where they are served in skeps without any attention to the weight given.

**Dietaries for Milking Cows.**—Attention has already been called to the great demands on nitrogenous matter involved in the supply of milk. A good cow will yield 5 or 6 gallons of milk a day, or 50 to 60 lb., containing 12 per cent of solids. The fat is more easily supplied than the protein, and it is worthy of serious attention that a cow

giving 6 gallons of milk per day supplies .36 lb. of nitrogen in the shape of casein albumen, whey, and other nitrogenous matter. Nitrogenous foods are therefore especially necessary for cows in full milk, and it must be remembered that such a cow yields the greater part of her milk during the first few weeks of lactation. For example, a cow which yields 800 gallons during the entire milking period may easily give half of this amount in the first three months, i.e. at the rate of 5 gallons a day. Such a cow would therefore discharge in her milk .3 lb. of nitrogen or 1.875 lb. of albuminoids every day on the basis of 6.25 of albuminoids to 1 of nitrogen. Besides this considerable quantity of nitrogen required for her milk, she must find an additional amount for supplying the waste of her own body, and in most cases to build up a fetus, and hence no one need wonder that a cow in full milk is voracious in her appetite.

If we now turn to the nitrogen content of foods, we may take grass as the most natural diet, and one which cannot be excelled. Pasture grass contains approximately 4 per cent of nitrogenous substance (albuminoids and amides) or .64 per cent of nitrogen. It would therefore take 47 lb. extra of grass to supply the nitrogen for 5 gallons of milk, and how much more for the support of the cow's body and the necessary waste and growth of the fetus it is needless to inquire, as it would be the same in a dry cow in calf. It is the extra food to which attention is directed.

If the same cow, yielding 5 gallons of milk per diem, were on winter food she would require 8½ lb. of rough cotton cake, in addition to a maintenance diet of good oat straw and 3 lb. of cotton cake, i.e. 11½ lb. of cotton cake + oat straw.

Amount of nitrogen discharged in the milk . . . . . 3 lb.  
Amount of cotton cake to supply the .3 lb. of nitrogen 8.5 lb.

If, however, the cow is *rationaly* fed, and receives a mixed diet of oat straw, and, let us say, 20 lb. of meadow hay, 56 lb. of mangel, and cotton cake, how much cotton cake would she require? Supposing that the straw, hay, and mangel represent a fair maintenance dietary, she would still require 8½ lb. of cotton cake. Or if it be preferred to substitute a mixed diet of cotton cake, bean meal, and dried grains, instead of all cotton cake, the following amounts would theoretically supply the necessary dietary for maintenance and milk supply.

Oat straw . . . . .	<i>ad libitum</i>				
Meadow hay . . . . .	20 lb.	} maintenance.			
Mangel . . . . .	56 "				
Bean meal . . . . .	2 "				
Dried grains . . . . .	3 "		.0812	nitrogen in pounds	} extra food for the cow in milk.
Cotton cake . . . . .	3½ "		.0990	" "	
			.1232	" "	
Total nitrogen for milk . . . . .			.3034	" "	

Such a dietary is both scientific and practical, and would be considered economical, as the artificial foods would not cost more than 3s. per week. It is a fair and liberal mixture, as the animal will be able to satisfy its appetite on oat straw, if the 8½ lb. of roots and dry foods are not sufficient.



### 300 LIVE STOCK, FEEDING, AND ECONOMIC ZOOLOGY.

**Dietaries for Young Cattle.**—The colostrum, or first milk of cows, contains 17.6 of albuminoids or 2.8 of nitrogen, and possesses an albuminoid ratio of 1 : 0.6, or nearly 2 : 1. This is extremely high in comparison with normal cow's milk, in which the ratio is as 1 : 3.7, and still more striking in comparison with that of cereal grains, which is 1 : 5. The albuminoid ratio of fresh and young grass may be 1 : 4.2, and in ordinary pasture grass it may be 1 : 7. All depends upon the relations of the total nitrogenous substance to the true albuminoids, and the ratio may vary from 1 : 4.5 to 1 : 7.4, according to the method of calculation followed. Young grass and milk are Nature's food for calves, but entail a great sacrifice of new milk. Besides, the time during which it is available is comparatively short, and, as already pointed out, late calves are better in the house, and fed with milk substitutes, cut green food, and artificials.

All young cattle should receive a nitrogenous dietary, in which linseed cake occupies an important place. They ought not to be overfed, but during their first winter may receive one-quarter the average allowance given to fattening oxen, i.e. 2 lb. of cake and meal per head instead of 8 lb. Uncorticated cotton cake is not suitable for calves, and even decorticated cake is better mixed with linseed cake in the proportion of half and half. It is important that the appetite should be satisfied, and this is most easily accomplished by supplying the racks or "hecks" with sweet oat straw, and providing a supply of clear and sweet water. Two-year-olds may be allowed rough cotton cake, and the allowance of artificial foods may be doubled, but the amounts given will be regulated according to their final destination. Dietaries for horses, sheep, and pigs are treated upon separately under their respective sections.

## CHAPTER VII.

### ECONOMIC ZOOLOGY.

THE agricultural importance of an economic knowledge of zoology cannot well be over-estimated in view of the great variety of diseases of both stock and crops which are directly traceable to parasites and other forms of animal life.

Parasites are of two kinds, namely, Epizoa, or external parasites, such as the flea; and Entozoa, or internal parasites, such as the tape-worm. In the former case the treatment, consisting of lotions, ointments, etc., is usually applied to the affected parts of the skin, for the purpose of killing the parasite without at the same time injuring the host, while in the latter case drugs are administered internally.

Parasites may also be completely or only partially parasitic in character, but most of those with which we are concerned in agriculture belong to the latter class and are only parasitic during a portion of their existence.

**Trematoda or Flukes.**—Of these the liver fluke (*Distomum hepaticum*) (Fig. 139) is the chief one of economic importance, being responsible for the disease known as liver rot in sheep. This fluke or flat-worm is about 1 inch in length and  $\frac{1}{2}$  in. across its broadest part, and presents an oval leaf-like appearance. In the case of an infected sheep the bile-ducts of the liver contain large numbers of these flukes, which are each provided with two suckers, one *oral* and the other *ventral*. The flukes in the liver produce large numbers of self-fertilized eggs, which are expelled with the dung of the sheep, and before maturing into adult flukes pass through a number of stages. In the first stage the sole chance of life of the young embryo depends upon its meeting a certain species of water-snail (*Limnaea truncatula*) (Fig. 139, C), and after undergoing further changes in the body of the snail, it leaves the latter, swims about in the water for a short time, and finally becomes encysted or encased on the stems of damp grass, when, if devoured by a sheep, it quickly develops into the adult fluke.

**Symptoms.**—In the early stages of the disease in autumn the sheep appear to do well, as the parasites at first stimulate the liver and aid digestion. Later, however, the skin becomes doughy, and the eye has a whitish, opaque appearance under the lid, commonly known as "fat-eye". From January onwards the animal becomes very anæmic, swellings appear under the jaw, and finally emaciation and death ensue; while even if the sheep recovers, the effects of the disease never disappear.

*Treatment.*—This consists in having well-drained pastures, as by drying pasture land the snail which is necessary for the propagation of the pest is eradicated. Salt is very harmful to the parasite in all its stages, and the land should therefore be dressed with it, while a good preventive is to give the sheep a plentiful supply of rock-salt in their troughs. Gas-lime is also beneficial as a top-dressing for infected pastures. All livers of infected sheep should be destroyed, and never given to dogs, or the eggs of the fluke may be returned uninjured to the soil. The best preventive is sound, dry land, and flocks should never be allowed to graze on rushy or

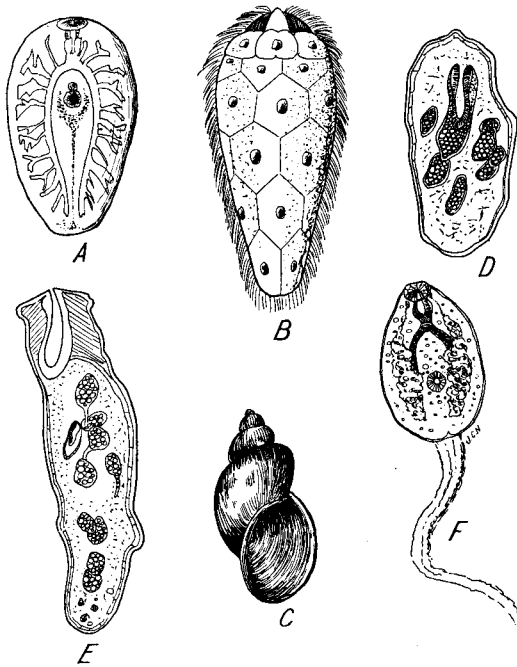

FIG. 139.—Liver Fluke (*Distomum hepaticum*). A, adult fluke; B, ciliated embryo; C, water snail (*Limnaea truncatula*); D, sporocyst; E, redia; F, cercaria.

wet lands—especially after midsummer. The spring feed of water-meadows is not dangerous.

**Cestodes or Tape-worms.**—The tape-worm (Fig. 140) is a long, flat worm, entirely parasitic; it is segmented, each segment being practically a perfect animal in itself, and when these segments are sexually mature and full of eggs they fall off from the worm and are expelled, the eggs they contain then being disseminated through both soil and water. Tape-worms possess no mouths, but attach themselves firmly to the mucous membrane of the intestines of the host:

by means of hooks and suckers, while they feed by the process of "osmosis", i.e. the nutriment is absorbed directly through the skin.

*Symptoms.*—After the egg of a tape-worm has been taken in by some omnivorous, herbivorous, or, more rarely, carnivorous animal, it is carried along in the form of an embryo to some organ of the host, where it becomes converted into a cyst or "water-bag". The latter grows to a large size, with liquid contents, and after a time forms one or more hollow buds projecting into the interior, and containing the embryo head, or heads, of future tape-worms. When the cyst is consumed, therefore, with the flesh of the animal in which it exists,

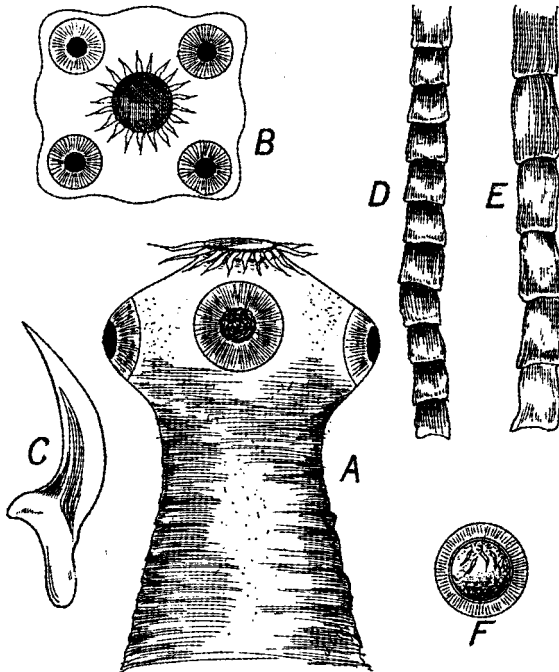

FIG. 140.—Tape-worms. A, *Tania solium* of man; B, scolex or head seen from the front; C, one of the hooks; D, E, joints or segments; F, ovum or egg.

these rudimentary heads are released, and develop as the adult tapeworm in the intestines of the new host, where they commence to bud off segments as before. "Measles" in beef and in pork are both caused by distinct species of tape-worms, *Tænia saginata* and *T. solium* respectively. The cystic stage of the former is found in the muscles of the ox, and of the latter of the pig. If the flesh of the infected animals is not eaten by man the cysts in time become calcareous; otherwise they become converted into the adult tapeworm in the human subject. To destroy the cysts the meat must be

thoroughly cooked at a temperature of from 140° to 150° F., but it is impossible to treat living infected oxen or pigs, owing to the fact that the cysts are inaccessible.

The *Tænia cœnurus* (Sturdy, Staggers, or Gid of Sheep).—This is found in the dog, but the eggs when taken in with their food by sheep develop into the cystic stage in these animals, usually becoming embedded in the brain itself (Fig. 141), where they often attain the size of a hen's egg, and cause the disease known as "sturdy", "staggers", or "gid".

*Symptoms.*—The cyst affects the conduct of the animal according to the position it finally occupies in the brain. Thus, if situated in the fore-part of the brain the sheep raises its nose and walks straight forward; if on one side, the animal walks round in that direction. If it is in the back of the brain the sheep stumbles forward in a jerky manner, frequently falling and struggling to get up. The

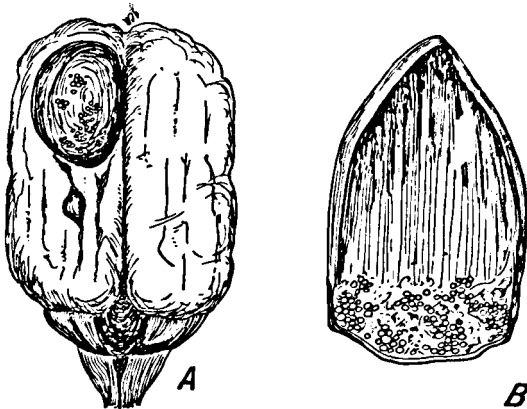

FIG. 141.—Sheep Sturdy or "Gid". A, *Cœnurus cerebralis* encysted in brain of sheep; B, section through cyst.

position of the cyst may therefore be deduced from the conduct of the animal. The life-history of the tape-worm is completed by a dog eating the brain of the diseased sheep, which enables the parasite to begin a new cycle of changes.

*Treatment.*—Very little can be done in the way of treating giddy sheep, and the loss in a flock is sometimes considerable. Operative treatment is sometimes attempted by piercing the skull of the animal and puncturing the cyst; but it is not usually followed, as the animals are generally sent to the butcher. Damp pastures are favourable to the preservation of the eggs, and care must be taken to see that all diseased brains are destroyed.

*Tænia echinococcus* of the dog is a very small worm, but is responsible for the production of the largest-known cyst, which takes up its position in the liver or lungs of the ox, sheep, pig, and man

also, not unfrequently attaining the size of the human fist. The disease is rarely fatal, but the animal becomes extremely unhealthy, and the disease is difficult to diagnose, although the liver is very greatly increased in weight, often as much as ten times.

*Treatment.*—This usually consists in fasting the animal for from eighteen to twenty-four hours, and then giving a dose of 2 grains of arca-nut for every 1 lb. weight of the animal; and this treatment should be repeated every fortnight or three weeks until a marked improvement is noted.

Thread-worms are so called on account of their appearance. They are nearly all wholly or partially parasitic, and live on the organic faces of animals. The sexes are usually separate, the male being distinct from the female. Some thread-worms lay eggs which may develop into a larval stage before maturing, either in the same host as the adult or another, or the larvæ may not be parasitic at all. On the other hand, the female worm may produce her young alive and in the thread-worm stage.

*Strongylus filaria* and *S. rufescens* both belong to the Strongyle groups of thread-worms, which take up their position in the lungs or bronchial tubes in calves and sheep, producing the disease known as husk or hoose, which is chiefly prevalent from September to March. Young stock are particularly prone to this disease when kept in poor condition and in damp pastures or water-meadows throughout the winter.

*Symptoms.*—These are first noticeable as a cold or slight catarrh, which afterwards becomes very painful, and is accompanied by convulsive coughing of an unmistakably "hoosey" character. The animal may eat well, but becomes poor and bloodless, and finally dies. If not, the symptoms gradually disappear after the winter is over.

*Treatment* is best carried out by feeding the young animals well in spring and summer, and allowing a plentiful supply of clean, pure water. Salt cakes are useful, and infested soil should be dressed with crushed rock-salt. If an animal is infected the best plan is to give an injection, directly through the neck into the windpipe, in order to kill the parasite, using potassium iodide and olive-oil, but this is best done by a veterinary surgeon.

The Armed Palisade Worm (*Sclerostomum equinum*) of the horse produces dangerous swellings of the blood-vessels, termed aneurisms when in its cystic form, and these may have a fatal termination. The mature worms are usually found in the intestines, the male being about 1½ inches, and the female 2¼ inches long.

*Symptoms and Treatment.*—In the majority of cases, where only a few worms are present, no symptoms are noticeable, but if present in large numbers the animal becomes anæmic, suffers severely from colic, and often dies. These worms are extremely difficult to eradicate, but the usual treatment is to administer medicine composed of thymol and santonine.

The Giant Thread-worm (*Ascaris megalcephala*) of the horse, when present, is usually found in the intestines in large numbers, and is from 11 inches long in the case of the male to 14 inches in the case of

the female. Very little harm results from their presence, but if in very large numbers the wall of the intestines may become ruptured.

*Treatment.*—This is somewhat unsatisfactory, but if from 1 to 3 drachms of arsenious acid be mixed with the food and followed by a purgative, it may result in the eradication of the worms.

The Gape-worm of Poultry (*Syngamus trachealis*) (Fig. 142) is found in the windpipe of birds, where its presence causes a peculiar cough, and the bird gapes in a characteristic manner in its effort to get rid of the irritation. The male and female worms, about  $\frac{1}{8}$  and  $\frac{3}{8}$  in. in length respectively, are nearly always found together in the form of a fork. After the production of the eggs the parasite dies and the eggs are discharged, and develop on damp ground or in water. Whether the eggs pass into the mouth of the birds, hatch out there, and so reach the windpipe, or whether they first reach the gut and go to the windpipe via the blood stream, is not definitely known. The final result is that the bird is suffocated and dies.

All infected birds should be at once isolated and treated, by placing them in an airtight box into which a mixture of camphor and chalk may be sprayed by means of any of the patent machines now on the market for the purpose. The bird by inhaling the fumes destroys the parasite, which is then readily coughed up. Cruder

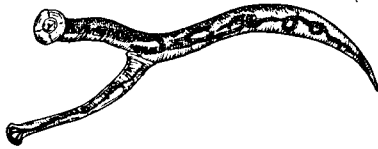

FIG. 142.—Gape-worm (*Syngamus trachealis*).

methods, such as fishing down the throat of the chick with a feather dipped in oil of cloves to catch the worm are sometimes adopted, but they are somewhat cruel and cannot, therefore, be advocated.

*Eelworms.*—These parasites cause malformation and "sickness" of numerous plants, and are very difficult to deal with. They are minute nematode worms, and their presence is not often suspected on account of their microscopic size. One end of the parasite is blunt, and comprises the head and very powerful sucking organs, while the posterior extremity is pointed, and is used to pierce the stem of the affected plant, so that the juice may be sucked from the tissues, after which the parasite bores its way up the stem.

The "Stem" Eelworm (*Tylenchus devastatrix*) (Fig. 143) attacks oats, rye, wheat, potatoes, hops, and clover, causing clover sickness (*vide* Plant Diseases, p. 575). The symptoms vary somewhat; for example, some plants soon become yellow and die, while others appear to grow luxuriantly and possess thick abnormally fleshy leaves. No ears are, however, produced; or, if they are, they are quite useless. The eelworm passes from the soil, where the eggs are laid into the roots of the plant, and so up the stem, but it leaves again before the plant dies, and again deposits eggs in the soil.

*Treatment.*—The most satisfactory treatment consists in securing a good rotation with the possibly affected crops as far apart as possible, or in other words starving the parasite out. Deep ploughing may also be resorted to, in which case the eggs are prevented from reaching the surface and developing into the adult parasite.

Peppercorns, Ear Cockle, or Wheat Eelworm (*Tylenchus scandens*) (see Fig. 30, B) differs from the last-mentioned in that it only affects the ear of the wheat plant, causing galls commonly known as peppercorns. These contain hundreds of dormant larvæ, which may remain in a state of suspended animation for a considerable number of years,

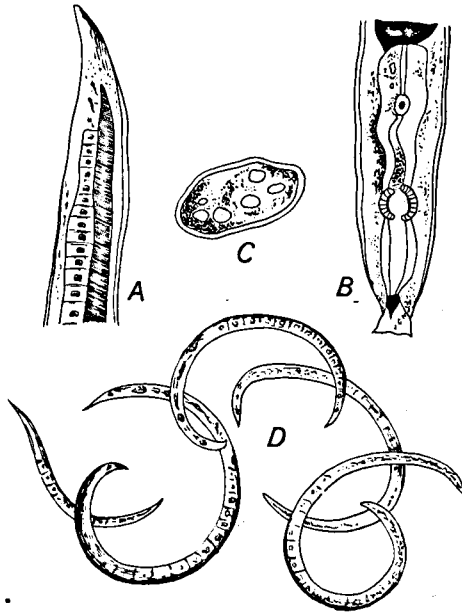

FIG. 148.—Eelworm (*Tylenchus devastatrix*). A, posterior extremity of male; B, anterior extremity; C, ovum; D, eelworms from clover roots.

but on reaching the soil they develop into mature eelworms. The latter enter the roots, travel up the stem, and take up their position at the base of the ear, when the plant flowers, and the galls or peppercorns are then produced. Great care should be taken to see that these latter are not sown with the seed, and this may be prevented by soaking in a weak solution of sulphuric acid, so that the germination capacity of the wheat is unharmed, but the peppercorns are killed; or they may float on the surface and may be skimmed off. If an affected grain is cut across and immersed in a tumbler of water the worms escape and may be



seen moving freely in the clear water if it is illuminated by bright sunlight.

Beet Eelworm (*Heterodera Schachtii*) produces a disease known as "beet-sickness", the plants becoming weak, and the leaves limp and colourless. The disease may be diagnosed by the presence of small projections on the rootlets of the plant, caused by the eelworm, which is citron-shaped, taking up its position there. The soil may be badly affected with the eggs and larvæ of the parasite if beet is continuously grown.

*Treatment.*—A machine has now been invented which, when drawn over a field of beet, breaks off the small rootlets of the affected plants, so that the parasites are killed before their eggs are laid, without further injury to the crop. Lures in the form of varieties of the cabbage tribe planted with the beet, and pulled up and burnt when their rootlets are covered with the parasites, have also been found useful.

The Earthworm (*Chætapoda*, i.e. Bristle-footed) possesses a long body composed of a number of segments, on each of which are eight bristles shaped like a drawn-out S, and capable of being projected either forwards or backwards. The body is pointed at the anterior end, becomes larger at the middle, and then gradually flattens and narrows down towards the posterior end. These lowly organized animals are of considerable economic importance, and although they are said to be responsible for a certain amount of damage to celery and onions in gardens, this is out of all proportion to the beneficial action which they exercise on the soil. In feeding on decayed organic matter and in making burrows worms swallow a considerable amount of soil, which is discharged in the form of "castings" in a much higher state of fertility, having been moistened by the digestive juices, and ground up into a much finer mechanical condition.

The earth is constantly being brought up in this form from below and deposited on the surface, and, moreover, it is evident that it is only the finer particles of the soil that can be swallowed, and therefore the heavier particles and mineral fragments must necessarily sink. Or, in other words, the soil is filtered, as it were, the light, fine particles being brought to the top, and the coarse and heavier parts sinking below. The importance of the cumulative effects of these small animals may be demonstrated by the fact that it is estimated that the amount of soil filtered, ground down, and fertilized by their digestive juices on an acre of garden soil in one year is roughly 10 tons, or sufficient to cover that area with a uniform layer  $\frac{1}{2}$  in. thick.

*Arthropods.*—This division is estimated to comprise about half the number of animals known to exist, and includes centipedes, millipedes, insects, spiders, mites, etc. All are jointed animals, and each joint moves only in one plane, so that a large number of joints are necessary to perform any complicated movement. Their bodies are segmented, and these segments are usually arranged in groups. All Arthropods possess an external skeleton of hardened skin, or "chitin", and grow by moulting, developing rapidly, and having

a new chitin deposited in place of the cast-off skin. Respiration is carried on in some cases through the skin, but most of the animals have a special breathing apparatus, known as spiracles, communicating with the air through openings in the skin. The Arthropods may be divided into the following groups:—

1. Myriapods . . . Centipedes and millipedes.
2. Arachnids . . . Spiders, mites, etc.
3. Hexapods . . . All true insects.

1. **Myriapods.**—Centipedes and millipedes are liable to be both classified as injurious by the tyro, but in practice it is most important for the agriculturist to distinguish between them, as centipedes are quite harmless, and even beneficial, while the millipedes are extremely harmful and troublesome. Neither of these animals has wings, and their bodies are made up of a number of segments provided with legs. There is no metamorphosis in their life-history.

Centipedes may be distinguished by the fact that their transverse section is flattened, and each segment possesses *one* pair of legs set wide apart. They are usually found in dark damp places, and are wholly carnivorous, feeding on insects, snails, etc.

Millipedes, on the other hand, appear to have *two* pairs of legs to each segment, set close together, and the transverse section of the body is round. When touched they coil up, move much slower, and have a larger number of segments than the centipedes. They are wholly herbivorous, and feed on plant tissue, often attacking onions, turnips, wheat, beans, and even strawberries, with disastrous results.

On a large scale the only practical remedy is to work lime thoroughly into the soil, while in gardens they may be eradicated by luring them with poisonous bait, Paris green being used for this purpose.

2. **Arachnids.**—Spiders (*Araneidæ*) are not segmented, but the body is divided into two portions by a constriction. They possess four pairs of walking legs and two appendages in front, which assist in feeding, and this characteristic distinguishes them from insects which possess three pairs of jointed legs. The organs of mastication in the spider are wholly carnivorous; hence true spiders are incapable of feeding on plant tissue, and consequently may be rightly considered as beneficial rather than antagonistic to the farmer.

*Mites and Ticks (Acarina).*—In contrast to the true spiders these are very harmful, and are distinguished by possessing bodies in one piece, rounded on the top and flat on the under surface. They possess the same number of appendages as spiders, and are often responsible for producing serious diseases in both animals and plants. Most mites lay eggs, and their metamorphosis is very simple. The young mite which hatches out from the egg differs from the adult in having only three pairs of walking legs, but it very soon moults, and with its new skin acquires the characteristic number.

Red spiders are not in reality true spiders, and cause considerable damage to garden plants and trees by feeding on them and sucking their juices, protecting themselves on the under side of the leaf by spinning a shiny web, under cover of which they carry out their

depredations. Treatment under glass usually consists in fumigating with prussic acid; and in the open by spraying with a sulphur-paraffin emulsion.

The harvest bug, in reality the larva of a large scarlet mite (*Trombidium holosericeum*), is parasitic on the skin of many mammals, including man, dogs, horses, cats, etc., and poultry are also sometimes attacked. These undesirable six-legged larvæ swarm in long grass and undergrowth in late summer and autumn, and upon attaching themselves to the skin of the host they bury their heads deeply underneath the cuticle so that they may not be dislodged. For horses and dogs a 2 per cent solution of carbolic acid will usually prove both preventive and curative, while in the case of fowls the feathers should be well dusted with flowers of sulphur.

*Ticks (Ixodidæ)* (Fig. 144).—These pests are partially parasitic in character, and possess very distensible, and leathery, skins. They suck the blood of the host by means of a beak consisting of two "scrapers" and a "dart", the former making the wound in order that the dart may be plunged in. The male is smaller than the female,

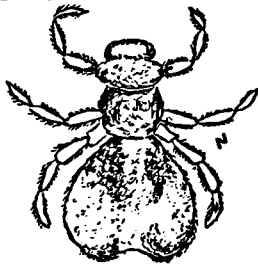

FIG. 144.—Sheep Ked or common Tick of Sheep (*Melophagus ovinus*).

and is not capable of distending to so great an extent. All ticks lay eggs, and possess four pairs of legs in the adult form. The sheep tick is one of the most important of these parasites, and it is usually found around the roots of the ears, inside the thighs, and wherever the wool is thickest. The ticks do not injure the sheep to any great extent unless present in excessive numbers, and are readily destroyed by any of the various sheep dips.

*Itch Mites (Sarcoptidæ)*.—These are wholly responsible for the disease known variously as the "itch", "mange", or "scabies", according to the subject attacked. Moreover, the cause of these diseases is due to different varieties of the pest, according to the species of the animal affected.

Sarcoptic mange in horses usually occurs in overworked, badly fed, and old animals. The mites make punctures in the skin, into which they inject an irritant substance causing a viscous exudation from the wound, which on drying forms a pimple. As the parasites increase, and the punctures get closer together, the pimples form patches, the hair drops out, the skin becomes wrinkled, and the animal is in a constant state of irritation. The disease is highly infectious;

and infected horses should at once be isolated, and all grooming implements disinfected.

The animal should first be clipped, all clippings being afterwards burnt, and then should be well rubbed over with soft soap so as to soften the crusts. Then lather it well, and wash with warm water, finally killing the parasites by the application of a creosote dressing, composed of 10 parts of creosote, 10 parts of methylated spirit, and 25 parts of water. The dressing will require to be repeated two or three times, at intervals of about five days, as, although the first application will destroy the adults, the eggs still survive, and must be destroyed as they hatch.

Sheep scab is also due to itch mites, the exudations from the punctures forming large offensive scabs, around the margin of which

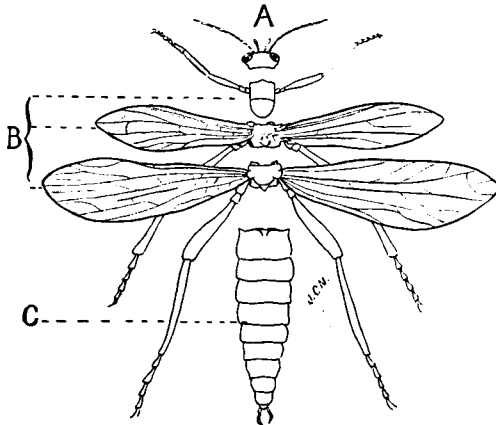

FIG. 145.—Generalized Insect. *A*, the head, containing the chief organs of sense and feeling, together with the mouth; *B*, thorax, containing the organs of locomotion; *C*, abdomen, made up of fourteen segments or less, and containing the organs of digestion and reproduction.

the mites may be discerned. The disease is highly infectious, and notification to the local authorities is compulsory.

Sheep dips are recognized as effective, and should contain ingredients for softening the scab and also for killing the parasites. lime being often used for the former purpose and sulphur for the latter. Arsenical dips are largely used, and are perhaps the most effective, but non-poisonous dips are also on the market.

Demodectic scabies or mange in dogs is a further example, but in this case the parasites possess long bodies with the characteristic four pairs of legs. They are found in the follicles of the hair itself, and are consequently very difficult to eradicate, surface washing being of little avail. Treatment usually consists in the administration of internal medicines, e.g. quinine, which may be excreted through

the skin, after which all surface parasites may be destroyed by applications of Peruvian balsam.

3. Insects.—This last and widely extended family of Arthropods comprises by far the greater majority of those animals which are destructive to farm crops. It also includes several species of an undoubtedly beneficent character, either from the fact that they wage war on noxious insects in certain stages of their existence, as does the Ichneumon fly, or, as in the case of bees, in performing exceedingly useful work in the fertilization of fruit-trees and clovers.

In all true insects the body is divided into three sections (hence *insecta*), namely, the head, thorax, and abdomen (Fig. 145). The head may be defined as the sensorium or organ of the senses, while the thorax is essentially the motor part of the animal, and possesses the legs and wings, always three pairs of the former and usually two pairs of the latter, although the second pair are not always distinctly discernible; or the first pair may be modified to afford protection to the posterior pair. The life-history of all insects comprises a cycle of four stages as follows:—

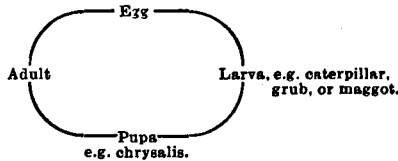

The larval stage represents the feeding period in the life-history, as it is then that food is stored up for use by the adult insect later on. Moreover, it is during the larval stage that herbivorous insects are the greatest source of trouble to the agriculturist. Types of insect larvæ are almost innumerable, but it is important to note the distinction between those of a harmful and harmless character, or in other words those which are herbivorous and those which are carnivorous. The former possess toothed, rasping jaws designed for feeding on plant tissue, while the latter possess sickle-shaped and pointed jaws.

As a general rule it may be noted that a "caterpillar" will finally develop into a butterfly or moth, a "maggot" into a two-winged fly, and a "grub", with three pairs of legs and conspicuous jaws, will become a beetle.

CLASSIFICATION OF INSECTS.

1. Aptera . . .	Wingless . . .	Primitive or ancestral.
2. Orthoptera . . .	Straight-winged . . .	Earwigs, cockroaches, grasshoppers.
3. Neuroptera . . .	Nerve-winged . . .	Dragon-flies, lace-wings.
4. Hymenoptera . . .	Membrane-winged . . .	Saw-flies, Ichneumon flies, bees.
5. Coleoptera . . .	Sheath-winged . . .	Beetles.
6. Lepidoptera . . .	Scale-winged . . .	Butterflies and moths.
7. Diptera . . .	Two-winged . . .	True flies.
8. Thysanoptera . . .	Fringe-winged . . .	Thrips.
9. Hemiptera . . .	Half-winged . . .	Bugs or plant lice.

The Aptera, Orthoptera, and Neuroptera include very few insects of agricultural significance, and may, therefore, be lightly passed over. Among the Neuroptera, however, are the dragon-flies, and these highly organized and beautiful insects are distinctly beneficial. They possess great powers of flight, and possess three pairs of legs, not used for locomotion, but provided with spines for the purpose of securing the butterflies, moths, or flies on which they prey.

The Hymenoptera comprise ants, bees, wasps, saw-flies, Ichneumon flies, and gall-flies, all very highly organized insects. Their chief characteristic is that their second or posterior wings are smaller than the first pair, and are so locked that both pairs are used for flight and often appear as a single pair. The head is attached to the thorax by means of a neck, but while there is another constriction lower down at the waist this marks the actual division between the thorax and the abdomen. The feeding organs are of the suctorial type, and there are considerable differences between the larval and adult stages, which necessitate a sudden and often abrupt metamorphosis. The larvæ of most insects are simple in structure and rudimentary in character, e.g. maggots.

*Turnip Saw-flies* are sometimes extremely troublesome in hot, dry summers, and are so named because the adult female is provided with a beautifully devised sawing apparatus with which she cuts a deep incision in the leaf in which she lays her eggs. The larvæ are very destructive, and one simple remedy is to turn young ducks or pigs into the field, as they will quickly devour thousands of them. Deep cultivation prevents the flies from hatching out of the pupa stage, while swallows, swifts, and other birds destroy the adult flies, and rooks the larvæ.

*The Corn "Saw-flies"* (Fig. 146) are not true saw-flies, but the female possess a saw-like ovipositor with which a slit is cut in the stem of the plant for the deposition of the egg. The larva is white, and about half an inch in length when mature. It eats its way up the stem, and on reaching the top it saws through it so that the ear drops off. There is no curative measure for this pest, but the best preventive treatment is the deep ploughing of infested stubbles so that the chrysalids cannot hatch.

*Ichneumon Flies* are parasitic in their larval stages on the larvæ of other insects, and are extremely beneficial in ascertaining the position of such larvæ. They lay their eggs under the skin so that their larvæ when hatched may consume first the non-vital tissues of the host, and finally kill it, after which they pupate and the adult flies emerge in due course.

*Humble or Bumble Bees (Bombi)* are large, heavy, and hairy, and are provided with a slightly longer proboscis than the ordinary hive bee described in Part VI, Chapter III. It is on this account that they are useful for the fertilization of red clover; in fact, without their aid this particular variety could not seed. The second crop, having smaller flowers, may be readily fertilized by the aid of the ordinary hive bee.

The Coleoptera, or Beetles, are the dominant order of insects, and are easily recognizable. The outer pair of wings are modified to

form "wing covers" for the second pair, and meet in a perfectly straight dorsal line. Some beetles have no actual wings, but the elytra or wing covers are always present, although in some cases they adhere together. Beetles, as in the case of other insects, are of the greatest economic significance in their larval stages, many being harmful, as in the case of the cockchafer (Fig. 147), which does considerable damage in some seasons to both root, vegetable, and cereal crops. Their attacks can only be prevented by well-organized hunting, and destroying the adult insects in April, May, and June. Others are beneficial, as for example the ladybird, which in both larval and adult stages is wholly carnivorous, and should never be destroyed.

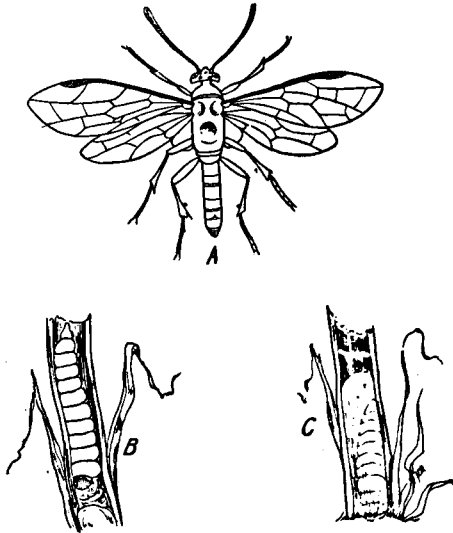

FIG. 146.—Corn Saw-fly (*Cephus pygmaeus*). A, adult fly; B, larva devouring inner parts of straw; C, mature larva.

*Wire-worms* are the long, tough-skinned, yellow or straw-coloured larvæ of the click-beetle or skip-jack (Fig. 148), and when present in the soil do considerable damage to crops of all kinds, often destroying the whole plant. They are very slow in development, taking from three to five years to become full grown. They pupate in the summer or autumn, and the adult beetles emerge before the winter or in the following spring. The beetle itself has a long, narrow, body, the sides of which are almost parallel, while the thorax projects backwards to form a point on each side. The perfect insect or beetle is quite harmless.

Treatment for wire-worm is usually unsatisfactory, but thorough consolidation of the soil by rolling is recommended, as it retards the

underground progress of the worms. Gas-lime, superphosphate, and acid manures will eradicate the pest if applied before sowing, while on an infested crop they are important in promoting vigorous growth.

The Turnip Flea Beetle or "Fly" (Fig. 149) is so called because it hops or jumps much in the same way as a flea. It possesses very powerful wings and a highly developed sense of smell. So powerful is this instinct or faculty that it will take long flights against the wind in order to get to a turnip crop. The larvæ are about  $\frac{1}{2}$  in. long, and burrow between the upper and lower cuticles of the seed-leaves of the young turnip plant, when, after some six days or so, they become full fed, fall to the ground, and pupate, the fully developed flea beetle emerging after about fourteen days from the chrysalides. As many

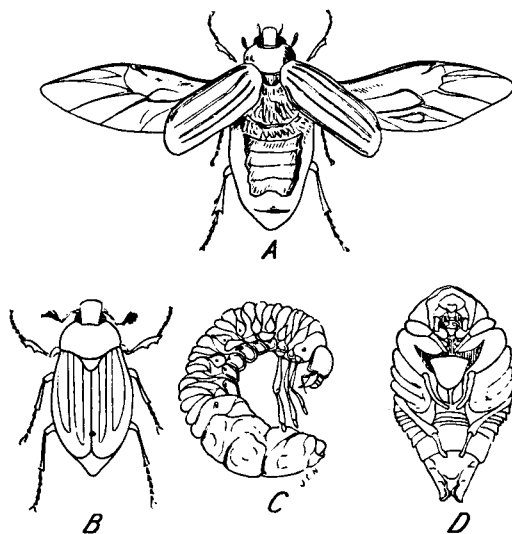

FIG. 147.—Cockchafer (*Melolontha vulgaris*). A and B, adult; C, larva; D, pupa.

as half a dozen broods may be produced in the course of a year, and both the adults and the larvæ destroy the leaves of the turnip plant, the attacks being worst in dry and hot seasons.

Numerous remedies have been proposed, among which are, dusting the young seedlings with lime in the early morning before the dew is off; soaking the seed in paraffin or turpentine before sowing, which imparts a distasteful flavour to the seedlings, while the germination of the seed remains unimpaired; brushing the crop over with tarred or greased sacking attached to a light framework, the insects leaping up on being disturbed, and adhering to the sticky surface of the cloth; or dragging paraffin-soaked sacking over the crop both ways, the odour of the oil stupefying the beetles.



*Grain Weevils (Calandra granaria).*—These extremely destructive insects occur among stored cereal crops. The eggs are laid by the female, one in each grain, during the summer, and the maggots soon hatch and devour the food material contained in the grain. They then pupate, and soon afterwards the perfect weevil eats its way out from the grain, the whole process occupying about six to seven weeks. The attack is difficult to detect, and the easiest method of diagnosing it is to throw a handful of the suspected grains on water, when any attacked grains will rise to the surface.

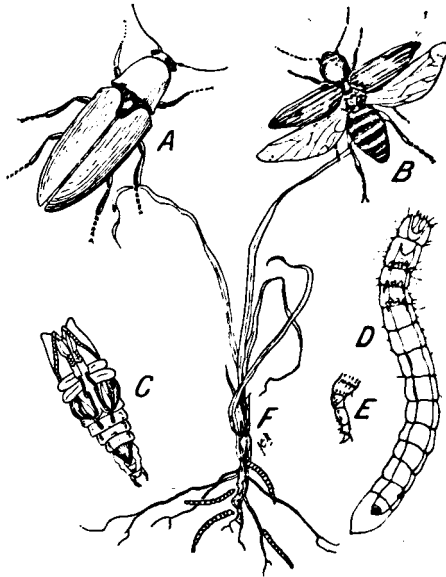

FIG. 149.—Wire-worms (Elateridae). A and B, striped click-beetle (*Agristes lineatus*); C, pupa; D, larva or wire-worm; E, jointed leg of larva; F, wire-worms attacking young corn.

The pest may be largely kept down by turning the corn with a shovel, as a reduction of temperature and ventilation arrests the insects immediately, but will not destroy their eggs. The most satisfactory remedy is to fumigate with carbon-bisulphide—which, by the way, is an exceedingly inflammable gas, and a naked light should never be brought near it. The liquid should be poured into a dish and placed on the top of the heap of grain, and the fumes will volatilize and permeate the heap, effectually killing all forms of insect life. The eggs, however, are not destroyed, and in order to be successful this treatment should be repeated after the lapse of two or three weeks, by which time the eggs will have hatched out and the larvæ

will be destroyed. This principle of discriminating between mature insects and their eggs or germs should always be kept in view.

Lepidoptera, or Butterflies and Moths, include many very beautiful forms of life of no direct importance to agriculturists. The body, legs, and wings are all covered with scales (Greek *lepra*), and the mandibles are very powerful, including a long proboscis or tube for sucking out the juices of plants. The larvæ are herbivorous, and constructed on the following plan: (1) the head, furnished with a pair of sharply toothed jaws and short antennæ or feelers; (2) three

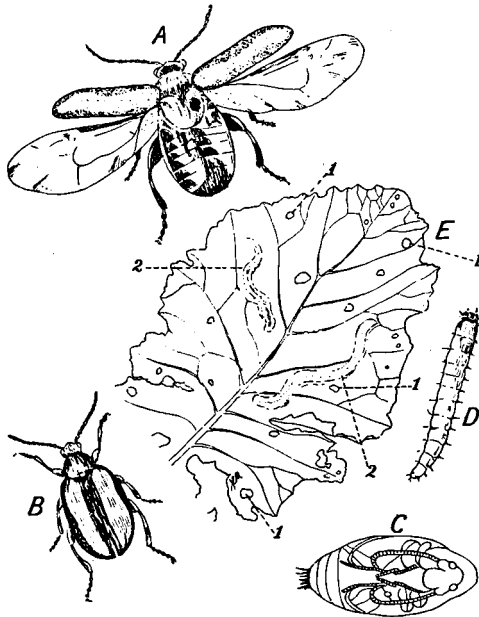

FIG. 149.—Turnip Flea or Turnip Flea Beetle (*Haltica nemorum*).  
 A, turnip flea with wings extended; B, the beetle or "fly";  
 C, pupa or chrysalis; D, larva or caterpillar; E, turnip-leaf;  
 1, holes made by beetles; 2, burrows formed by caterpillars  
 or larvae.

segments, each carrying one pair of feet; (3) two supplemental segments without appendages; (4) four segments with the elephantine or false legs; and (5) the last two segments devoid of legs. Thus the caterpillar possesses three pairs of true legs jointed and clawed, but the elephantine or false legs are neither jointed nor clawed, and consist of pushed-out skin, so that in reality the larva only possesses the number of true legs characteristic of fully developed insects.

*The Large White Cabbage Butterfly* (*Pieris brassicæ*) (Fig. 150) does considerable harm in its larval stages, more especially to garden produce. The caterpillars are greenish at first, and afterwards bluish above and yellow below, with a yellow line along the back. They are spotted with black markings, and carry tufts or a sprinkling of hair. They consume the leaves of the plant until nothing is left but the midrib and large veins, and are extremely voracious, often consuming as much as twice their own weight in a single day.

Ichneumon flies are beneficial in keeping down these caterpillars, one individual being the means of destroying an enormous number. Spraying may be resorted to as a remedial measure, arsenical

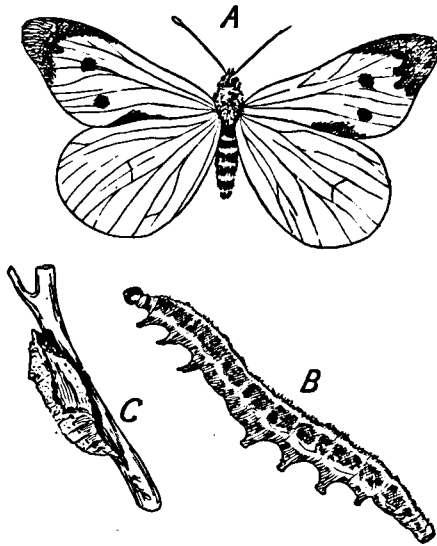

FIG. 150.—Large White Cabbage Butterfly. A, adult or imago; B, larva or caterpillar; C, chrysalis.

preparations such as Paris green affording the best results, while applications of powdered gas-lime or soot when the leaves are wet are also beneficial.

*Surface Caterpillars* are the larvæ of the heart and dart moth, and attain a length of about  $1\frac{1}{2}$  inches when full-grown. The caterpillars are somewhat flat in form, of a dull-lilac colour, and whitish green below. Each segment of the body, except the one next the head, possesses small tubercles, each tubercle being surmounted with a hair. The caterpillars feed during the night, and do considerable harm by gnawing the leaves off the crown of each plant, and then passing on to another.

Hand-picking is useful as a remedy, but more satisfactory results usually attend the application of a plentiful dressing of soot, while

probably the best plan of all is to put down bran sweetened with molasses, and sprayed with a mixture of 1 lb. of Paris green to 50 gallons of water. Infested land should not be deeply ploughed, and if the surface is well stirred in the spring numbers of the larvæ will be devoured by birds.

**Diptera** (two-winged), or true Flies, have been regarded as the most highly organized of all insects. The head is freely movable; it possesses large, compound eyes, and also antennæ with three joints. The mouth parts are very powerful, and may be adapted for sucking or biting. The wings are, of course, only two in number, and these represent the anterior pair of other insects, the second or posterior pair being now only represented by a pair of very small structures used as balances.

The metamorphosis is somewhat complicated; the larva is really nothing more than a somewhat degenerate maggot. The pupa varies as to its covering, which often consists of the skin of the larva unchanged. Sometimes the puparium or case may be secreted by the larva, so that if this be split open the skin of the larva will be found underneath.

*The Hessian Fly* has the appearance of a small brown gnat, the female being slightly larger and more numerous than the male. It occasionally appears in the month of May in this country, and the female deposits her eggs on the leaves of wheat, rye, and barley, but not oats. These eggs hatch out in from one to two weeks, the larvæ moving downwards and taking up a position at about the lowest node of the stem so that they are left behind in the stubble, and may therefore pupate there and cause a repetition of the attack the following year. On the approach of winter the larva forms a brown pupa-case called a "flax seed", inside which it pupates in the spring, the fly emerging ten days afterwards.

The damage to the plant consists in the stunting of the ear and the bending of the stalk, the larvæ being lodged between the leath-sheath and the stalk, where it is engaged in sucking the juices of the plant. It is important to sow a kind of wheat that is specially strong in the stem, and consequently less liable to lodge, while autumn wheat should be sown late so that flies may deposit their eggs on other plants. Deep ploughing and a proper rotation are both simple remedies.

*The British Wheat Midge* (*Diplosis tritici*) (Fig. 151) is a two-winged fly of elegant form which does an immense amount of harm to the wheat crop almost every season. It is of minute size, and hovers over the fields in July. The eggs are laid in the ear, and the maggots find a home within the pales. They are small, orange-coloured, sluggish, and readily found on opening the chaff scales. They suck the juices out of the young grain, and reduce it to the size of hen-corn, and are accredited with causing the loss of thousands of bushels. Many grubs are found in a single floret.

*Leather Jackets* include a variety of different species, among which is the common daddy longlegs, which appears from May to September. The larvæ are of a dull earth colour; they possess no legs, but have small fleshy processes on the posterior end of the body. They feed throughout the winter on the roots of all kinds of plants.

and are particularly noticeable in spring and early summer on clover, turnips, and garden produce. They pupate in August and September some distance below the surface of the ground, and the mature pupæ wriggle to the surface so as to allow the adult fly to escape. Undrained and uncultivated pastures are very favourable to the pest, which may therefore be mitigated to some extent by bush-harrowings and heavy rollings, while drainage is most important. Birds and voles also destroy the larvæ on a large scale.

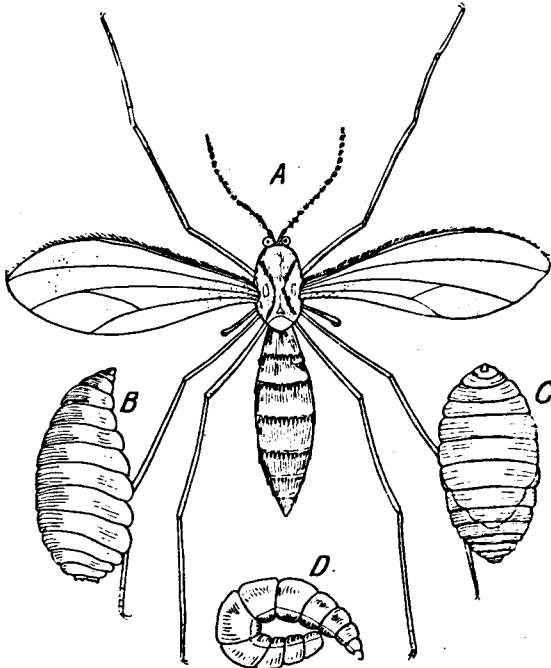

FIG. 151.—Wheat Midge (*Cecidomyia tritici*). A, adult; B, larva; C, cased larva or pupa; D, larva extended and doubled to spring.

The Carrot and Parsnip or Rust-fly (*Psila rosæ*) appears in spring, and is attracted by loose, open soil, or the odour of bruised carrots. The eggs are laid on the root of the carrot, just below the ground, and hatch out into small maggots about  $\frac{1}{4}$  in. long. The larvæ possess no legs and no mandibles, with the exception of two hooks by means of which they burrow to the lower part of the root, and then, in and out, in an upward direction, imparting a rusty-red colour to the root of the carrot. The leaves of the plant wilt, the tops wither, and it finally becomes rotten. Only late crops are affected.

Treatment consists in spraying the crop three times with paraffin emulsion—once after sowing, once after germinating, and once after thinning—so as to prevent the flies laying their eggs on the roots. Infested plants should always be removed and destroyed without loss of time.

The *Gout-fly* (*Chlorops tenuipus*), or ribbon-footed corn-fly, attacks various kinds of corn, but in this country it is most prevalent on barley. The eggs are laid one on each plant at the base of the ear as it forms. The larva or maggot is yellowish white in colour, and legless, tapering towards the head, and blunt at the tail.

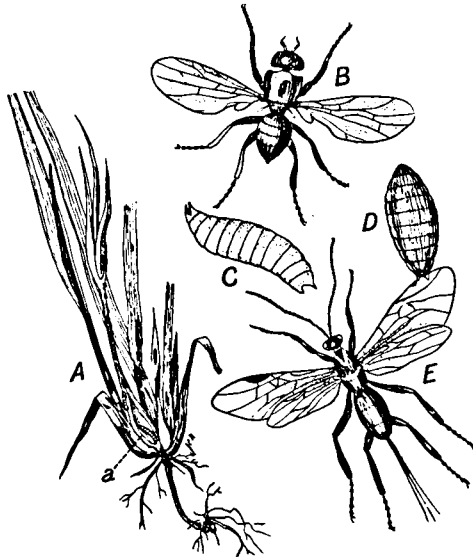

FIG. 152.—The Frit-fly (*Oscinis Frit*). A, a diseased oat plant in spring (a, larva of frit-fly); B, the frit-fly; C, larva; D, pupa; E, *Sigalphus caudatus*, a parasite of the frit-fly, which destroys the larvæ of the latter.

Its presence in the sheathing leaves of the plant causes the ear to become stunted and late in ripening, while the stem is sometimes distorted and swollen at the nodes.

There is no definite remedy for this pest, but in the case of infested crops the plants may be pushed on and ripened by the effects of stimulating manures. Spring-sown barley should be put in as soon as possible, so that it may be better able to resist an attack.

The *Frit-fly* (Fig. 152) is another dipterous insect which does great damage to oat crops, especially if sown late. It is a small, shiny-black fly about  $\frac{1}{4}$  in. in length. The attack takes place in

May or June, and is evidenced by extensive patches of bare ground and a general loss of vitality. The crop may partially recover, but can scarcely escape serious damage. The later broods are hatched in the ears, and do much harm to the grain. The best preventive appears to be early sowing.

The *Ox Warble Fly* (*Hypoderma bovis*) (Fig. 153) much resembles the humble-bee in appearance, being clothed with black, white, and yellow hairs. They are most active in bright sunshine, and are very rapid on the wing. Although cattle become greatly alarmed and often stampede when these flies approach them in order to lay their eggs, they are not harmed in any way by the flies themselves. The eggs, however, are deposited mostly on the forequarters of the animal,

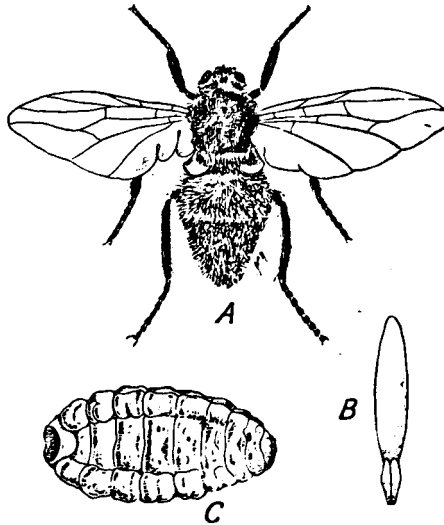

FIG. 153.—Warble Fly (*Hypoderma bovis*). A, ox warble fly; B, egg; C, larva or "ox bot".

where they adhere to the hair by means of special nippers, and in consequence of the irritation the animal licks the place. The larva hatches out in the stomach, whence it bores its way upwards into the body-cavity, through the muscles of the back, and finally takes up a position under the skin. Here it develops and increases rapidly in size, boring a small hole into which it pushes its spiracles or breathing apparatus, and feeding upon the inflammation products and the blood. The presence of these larvæ or maggots on the backs of cattle gives rise to the tumour-like lumps commonly known as "warbles", but the egg, as will be seen from the above, is not actually laid where the warble is found, as was formerly erroneously thought. The larvæ wriggle out of the tumour and fall to the ground before pupating.

*Treatment.*—In order to prevent the fly laying the eggs on the animal treatment usually takes the form of a dressing of cart-grease or paraffin or sulphur on the skin of the forequarters of the animals, but experiments have shown that this is not altogether satisfactory; the easiest method of destroying the maggots themselves, which is of the utmost importance in the eradication of the pest, is that of “squeezing out”, after which they may be crushed, and the skin of the animal then heals up quickly. Smearing the backs of affected animals with some ointment to block the holes of the warbles, and so kill the maggots, is often recommended, the best preparation to use for this purpose being probably a smear compounded of equal parts of Archangel tar and paraffin.

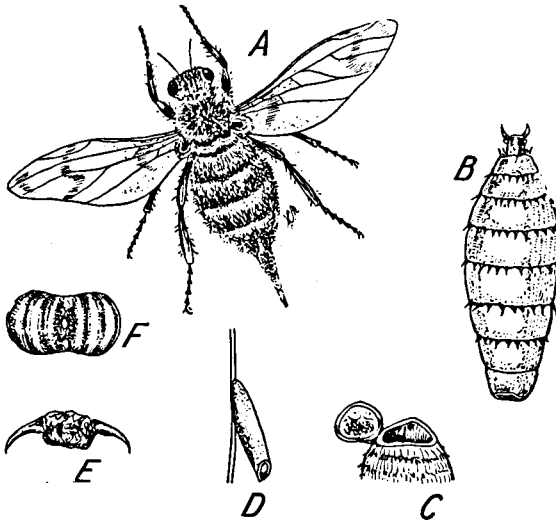

FIG. 154.—The Horse Bot (*Gastrophilus equi*). A, the horse bot fly; B, larva; C, end of puparium; D, egg of fly; E, hooked mandibles; F, spiracles at anal end of bot.

*The Horse Bot Fly* (*Gastrophilus equi*) (Fig. 154) is a very similar pest to the warble fly of the ox, the eggs being laid on the forequarters of the animals, licked off by the tongue, and conveyed to the stomach, where the larvæ can obtain a firm hold of the lining membrane by means of two horn-like structures. They remain in the stomach for some ten months until full fed, when they leave hold and are discharged, often being found sticking round the anus of the horse. They then seek shelter and pupate, 24 to 48 days after leaving the horse, the adult fly emerging after another 30 or 40 days. It is said that the presence of the bots in the stomach stimulates the digestive juices, but this is a doubtful advantage, as the mucous



membrane becomes permanently thickened and frequently perforated, in which case the health of the animal may suffer.

There is no remedy for this pest, and the best treatment is to dress the skin of the animal with creosote or paraffin as in the case of cattle.

*The Sheep Nostril Fly (Estrus ovis)* also has a similar life-history to the two last-mentioned pests, and appears from May to October. Sheep are greatly afraid of the fly, which as in the case of the warble fly is in itself quite harmless. The egg, or it may be the larva itself, is laid by the fly in the nostril of the sheep when the latter is chewing the cud. The larva pierces the mucous membrane, feeds on the products of inflammation, and works its way upwards to the frontal sinus (a bone cavity connected with the nasal chamber). Here it causes the animal considerable irritation, mucous and blood being emitted from the nose, the eyes becoming watery, and the sheep walks with a high-stepping gait, sometimes confused with sturdy or gid, from which, however, it may be distinguished by the fact that the animal never moves round in a circle. The larvæ remain in the sinus for some ten months, when they are discharged, and the trouble thus cures itself. When the larvæ are present in large numbers, say from sixty to eighty, death may ensue. Otherwise, treatment consists in making the animal inhale burning tar and sulphur. To prevent the fly from laying its eggs the muzzles of the sheep should be treated with tar; this may be conveniently effected by allowing the animals to feed from a trough which has a perforated cover smeared with tar.

Thysanoptera comprise very few species, but some of these are extremely harmful. The wings are four in number, very long and narrow, and possess a fringe on their margin, although in some cases they may be small or altogether absent. The larva differs from the adult in that it has no wings, and is of a different colour, usually yellow.

*Corn Thrips (Thrips cerealium)* are chiefly harmful to wheat, barley, and oats. The flies are from  $\frac{1}{8}$  to  $\frac{1}{4}$  in. long, of a shiny-black colour, and lay their eggs in the flower of the plant that is attacked. The larva is then hatched out and subsequently attacks the flower, taking up a position in the furrow of the grain, and sucking the developing fruit, so making the grain shrivel up.

There are no remedial measures when once the plants are attacked, but the attack may be mitigated to a great extent if the crop is sown early, as the grain then hardens before the larvæ of the thrips are mature. Deep ploughing and liming in winter are also beneficial, while, after harvesting, all crop remnants should be burnt.

Hemiptera, or "half-winged" insects, so called on account of the first pair of wings being in some cases half soft and membranous, and half tough. The second pair, if present, are always soft and membranous. The metamorphosis is in all cases gradual, the insect moulting a number of times; there is no inactive stage, the insect being active and feeding all the time.

*Green Flies or Plant Lice (Aphidæ)* are commonly found on all kinds of plants. The eggs hatch out in the spring, after remaining

dormant on twigs throughout the winter, into what is known as a "parthenogenetic" wingless female, or in other words a female which has the power of reproducing millions of young like herself without fertilization. But in order to prevent the colony from becoming choked by the production of so many wingless forms, winged females are evolved from time to time from a kind of pupal stage. As the autumn advances the sexual generation of male and female insects takes place, when the eggs are laid in readiness to hatch out on the approach of spring as above described.

The insects attack the leaves, stems, and roots of plants, the damage being worst in the case of a badly nourished crop, and in hot

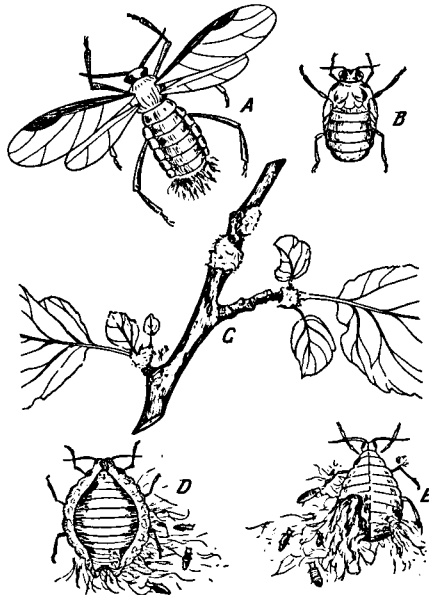

FIG. 155.—Woolly Aphis (*Schizoneura lanigera*). A, winged female; B, plant lice; C, affected branch showing white excretions; D, E, wingless viviparous females.

dry seasons spraying with a solution of soft soap is quite effective as a means of eradication, while paraffin emulsion or quassia may also be successfully used.

*Woolly Aphis or American Blight (Schizoneura lanigera)*.—These insects (Fig. 155), by means of glands situated on their backs, secrete a kind of wax which forms long woolly festoons often noticeable on apple-trees, to which they impart a whitewashed appearance, and serve as a protection to the insects. The life-history is similar to that of the Aphidæ above mentioned. Their attacks are not confined to the

stems of affected trees, but they are also found on the roots, in which case the health of the tree suffers considerably, and they are more difficult to eradicate. The damage is caused by the insect piercing the tissues of the plant and sucking the juices.

In winter, treatment should consist in the destruction of the hibernating insects by means of winter washes, while another plan is to whitewash the trunks of the trees, first scraping off all the rough bark to obtain a smooth surface.

For destroying the insects in the summer, syringing with soft soap solution, or paraffin emulsion, as soon as the first traces of white wool appear generally proves efficacious. In the case of roots attacked by the insects these are best exposed and treated with boiling water, which is quite effective in eradicating the insects and does not harm the tree at all. Injections of carbon-bisulphide into the soil are also used, but these prove harmful if they come into contact with the roots themselves.

*Scale Insects (Coccidæ)* possess a protection in the form of a characteristic scale which exhibits definite lines of growth, and is composed partly of a secretion from the insect itself and partly of the old skins which it sheds in moulting from time to time. The scales of the female are nearly always more prevalent than those of the male, which are smaller and different in shape. The eggs are laid under the scale in autumn, and present a white powdery appearance, hatching out into larvæ in the following year. The larvæ are found in great numbers in spring, and are provided with a beak which they plunge into the tree. In the case of the female it never moves from this position, but undergoes a series of degenerative moults, until it ultimately consists almost wholly of gut and reproductive organs. The male, on the other hand, forms a small scale, and after moulting possesses a pair of wings, and then fertilizes the female.

*The Mussel Scale (Mytilaspis pomorum)* is an example of a scale insect, but the male is very rarely seen, most of the females fertilizing their own eggs, and therefore being characterized as "parthenogenetic". The living insects may be destroyed by prussic acid or hydrocyanic acid gas, but in winter, when there are no living scales, the eggs cannot be destroyed in this manner, and the only practical remedy is to destroy both scales and eggs with paraffin emulsion.

*Slugs and Snails* may for all economic purposes be classed together, as they both belong to the same group, namely Mollusca, possess many characteristics in common, and are all harmful, with the exception of one slug, attacking practically all crops and especially garden produce. They move by means of a large flat muscular surface termed the "foot", possess two pairs of tentacles, and breathe by means of a large pulmonary chamber, so that they are asphyxiated on immersion in water. As a means of protection all species of this order are able to secrete a copious mass of slime, which may be discharged at least twice in succession, so that any dressings intended to destroy the pests must be repeated. Snails are also provided with an additional protection in the form of a large twisted shell into which the mollusc can retire, as it does when dormant during the winter, and the

aperture which is very securely closed by a hard plate formed on the "foot".

Slugs also possess a small shell in the form of a flat plate buried under the skin in the front region of the body. They feed on green crops, clover, turnips, and in fact all vegetable crops, and in winter lie torpid in sheltered places. They are not difficult to eradicate except when present in large numbers, and efficient drainage is also detrimental to them. As regards dressings, these should be such as may dry the surface of the skin and so kill the animal. For this purpose there is nothing to equal a mixture of 4 to 5 parts of salt and 10 to 12 parts of lime, provided that two dressings are applied, the second some ten or fifteen minutes after the first; preferably in damp weather in the early morning or late in the evening.

Snails cannot be treated in this way owing to the protection afforded them by their shells, and consequently a dressing which is distasteful to them must be used to drive them out. Soot or nitrate of soda is generally used, and these serve a double purpose by stimulating the growth of the plant in addition to providing something which will prove obnoxious to the pest.

## PART III.

*BUILDINGS, MACHINERY, IMPLEMENTS,  
AND ACCOUNTS.*

# PART III.

## *BUILDINGS, MACHINERY, IMPLEMENTS, AND ACCOUNTS.*

---

### CHAPTER I.

#### FARM BUILDINGS.

**Typical Plan of Farm Buildings.**—The accompanying plan (Fig. 156) shows a compact set of buildings adapted for a twelve-horse farm of from 400 to 500 acres. It is sheltered from the north, east, and west winds, and is open to the south. The various offices are easily approachable by gangways, gateways, and numerous doors, and are represented by yards, sheds, and accommodation for all kinds and classes of live stock. The main objects of such buildings are amply secured, such as plenty of space, shelter, and economy as regards labour; and it will be seen that each part is easily reached. The buildings form a quadrangle, of four parallel ranges of sheds, comprising as many roomy yards provided with sheds. The range upon the extreme east will be in closest proximity to the farm-house, and will be seen to contain the nag stable, gig-house, hospital, and calf-house, all requiring to be frequently visited. The work-horse stable opens towards the east on to a wide roadway, and is in close proximity to the implement and wagon sheds. The pigsties are placed as far away as possible from the dwelling-house, and are provided with a boiler. The barns occupy the north side next the rick-yard, and are two-storied. The upper floor (not shown) will consist of granaries and stores, and the ground floor is seen to be divided into mixing-rooms and fodder or root houses. The feeding passages ramify in all necessary directions from the mixing-floor. The cows are arranged head to head, but in the other plan given, they are preferably arranged back to back, and the yards are covered. The central gangway is wide enough to admit a wagon-load of straw, and to facilitate the work of carting out manure. The plan explains itself, and is worthy of study, and it is believed to combine all the essentials of a well-contrived set of buildings.

Farm buildings may be extremely simple or very elaborate. Their principal object is to afford shelter to live stock during winter; but they are also required for the storage of grain, etc. They may

take the form of a complete homestead, in which thrashing takes place, and where machinery is erected for pulping, grinding, chaff-cutting, and cooking food. They will also comprise straw barns, granaries, and dressing floors, stabling, poultry sheds, besides yards, stalls, and boxes for cattle. They are usually placed near the farmhouse, and convenient for inspection, so that the designing of farm buildings has occupied the attention of many eminent architects. In some cases the buildings are entirely roofed or covered, while in others they take the form of open yards and covered sheds. Even the

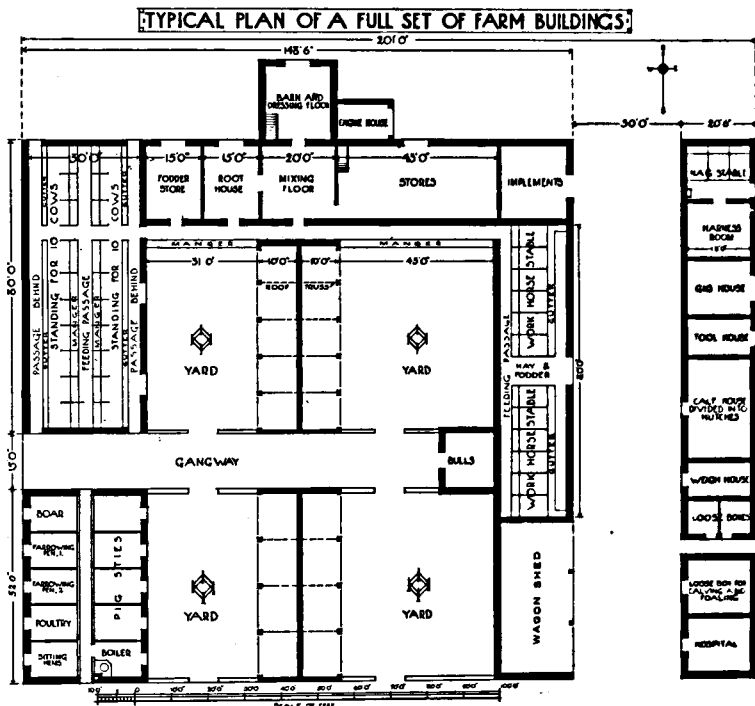

FIG. 156.

rick-yard has in a few cases been laid down with railways and turntables, and the ricks have been built upon trolleys, on which they are conveyed to the machine for thrashing. Similarly, the food may be carried on rails to the feeding stalls, and the manure to a receptacle for its storage. There are also liquid manure tanks, water tanks, bins, pumps, hoists, weigh-bridges, and other appliances too numerous to mention—the whole being very impressive, and conveying the idea of a factory rather than a farm.

It is not the intention at present to describe such a set of buildings ; first, because it would involve plans and elevations, as well as elaborate explanations, and also because there are good reasons for thinking that the day of complicated farm buildings has gone by. Fifty years ago, when Mr. Bailey Denton brought out his three guinea book of farm buildings, circumstances were in many respects different from what they are now ; but the changes have tended towards simplicity and less lavish expenditure.

Landowners are less attached to their properties, and farmers do not ask for complicated fixed machinery. The introduction of portable thrashing machines has abolished one of the principal features of a well-appointed set of buildings. Chaff-cutting is now done as a subsidiary operation to thrashing ; grinding is performed by powerful mills in towns, and at seaports, as also is kibbling and cake-crushing ; and the stuff is delivered at the farm fit for immediate use. There are now a large number of foods which require no grinding, such as germ meals, dried grains, molassine meal, molascuit, rice meal, lamb-foods, etc. There is little use for a bone-mill, and the consequence is that the whole system of fixed power with pulleys and shafting is less wanted even by large farmers. Pulping roots alone remain, but is not worth getting up steam for ; and as for waste steam for cooking chaff or potatoes, it can be more economically generated in a Barford & Perkins steaming apparatus. Those complicated arrangements for a fixed engine, with shafting running the whole length of a barn, and with sheaves and straps for multifarious implements, are at a discount—they add little either to the selling value of an estate, or to the rental value of a farm ; and few tenants are willing to take them over on valuation.

Another objection to a fixed homestead is the growing disposition to convert straw into food or manure, at a distance—nearer to where it is needed—and we now see fewer ricks brought home, but hay and corn stacks employed instead, as shelters for extemporized yards.

**Central Homesteads** suit compact farms of limited extent, where the fixed engine and thrashing machine are still features. Even in such cases it is doubtful if a farmer would ask for stationary mills and chaff-cutters, when he can cut up his straw in the field, and buy his feeding stuffs ready prepared.

In all centralized homesteads the barn is the central object. It is divided into upper and lower, and the granaries extend from the barn at right angles to the main buildings. The cattle sheds may stand on posts under these granaries, and the yards help to fill the quadrangle. The barns run north to south, and the granaries and stores east to west, thereby protecting the buildings from the north and east winds. The rick-yard is best on the north, and the range of stabling opens eastwards, while the piggeries and poultry yards are arranged symmetrically and conveniently for their attendants. The whole forms a compact set of buildings which is a great comfort to the occupier ; but, at the same time, it may mean a constant expense in haulage, and long distances for the teams to travel to and from their work. Even poultry are now found to do better in portable



houses pitched in the field, so that the bottom is knocked out of many of the advantages at one time claimed for complicated central steadings.

The homestead, however, still remains an important adjunct to a farm. It is the capital, where the farmer resides, and is also the proper place for the dairy, the milking sheds, and for butter and cheese making. It is from the homestead that the milk is dispatched to the *depôt*, and it is there that the stores are kept under lock and key. It is also there that grain is dressed for market, and the home-team is stabled; so that even where scattered buildings are more highly valued, the homestead still remains a feature of a well-equipped farm. The small grass fields which usually abut upon it are tenanted by calves and foals, that are better under the farmer's eye; and to outward appearance the homestead still remains much the same as it was.

It is seldom that its site needs to be fixed, because that has already been determined. It is always conveniently placed for roads, and usually occupies a sheltered position close to a good supply of water. It is often protected by trees, and, if not, they may readily be planted, for a belt of trees is both useful and ornamental.

As to *designing farm buildings*, sufficient has been said to show that they ought not to be planned on an ambitious scale. They should, however, be strictly in accordance with the requirements of the farm. This has not always been attended to, for buildings are to be seen adapted for fattening cattle on land which is evidently suitable for dairying and store cattle. Sheep-farmers do not need extensive buildings, and wide-lying farms are better provided with field barns and detached sheds and stables. Even cottages are better placed away from the homestead, where shepherds, stockmen, and teams-men are nearer their work.

The design should be economical, not only as regards initial outlay, but with due consideration to the daily labour of feeding and littering; and it should be of such a character as to secure the comfort of the live stock.

The foundations should be dry, and on a porous substratum. The materials will probably be brick and tiling, but timber and weather-boarding, posts, and rails, will be found durable, and in all respects satisfactory. Corrugated iron is a light and lasting roof, although rather unsightly, but grooved boards laid across purlins supported on main rafters last a long time. They are nailed to the purlins and follow the slope of the roof. They are spaced so as to allow  $\frac{1}{4}$  in. between them; and a continuous groove on either margin carries off the rain-water. This makes an excellent roof for a covered yard, and is both light and cheap and secures ventilation. There are many other forms of roofing for covering wide spaces, and no difficulty need be experienced in planning covered buildings or even covered rick-yards. It is, however, more likely that the existing buildings will require to be altered rather than new ones erected, and we therefore turn to another subject connected with buildings, namely their adaptation to new requirements.

**Adaptation of existing Buildings.**—This is often a comparatively simple matter, and need not entail much expense. It requires no architect, and may be accomplished in many cases by means of timber, hurdles, and other material ready to hand. In many old-fashioned buildings there is a big barn, flanked by large open yards, in which a pond receives the drainage from unspouted roofs. These buildings point back to a time in which corn crops were ricked and thrashed in the barn, and working oxen roamed over the outer courts, and were supplied with roots in long mangers at the back of what might now make an excellent wagon shed. These old barns may be over 140 feet long, and about 30 feet wide, and are divided into bays with thrashing-floors between. They are readily converted into milking sheds, and the accommodation may be increased by T-falls or lean-tos from the main roof for calves and young stock. They have, in fact, the makings of a covered building, and may be easily modified so as to do away with the necessity of open yards. The pond will then become clean, and the space around it useful for poultry, being made dry and sound, instead of being a morass of wet and rotten litter.

As to the internal fittings of the barn, it is sufficiently wide for a double row of cows, either to stand head to head on either side of a central feeding passage, or tail to tail with mangers arranged along the outer walls. Three feet nine inches is ample width for cow-stalls arranged in a double row, and with a length of 40 feet twenty cows can be accommodated. A large barn may be made to house sixty cows without any difficulty, with ample means of entry and exit, and room for stores of fodder. The lean-tos are also useful for bulls, calves, and heifers; and the old-fashioned and disused corn barn is thus converted into an up-to-date cow-shed.

In adapting old buildings to new uses space and sound roofs and walls are principal points. The floor can always be chalked, concreted, or paved with hard bricks; and the space divided by oak posts and rails. Light can be admitted by means of glass tiles, and air through half doors, loopholes, and ventilators. Drainage need not prove a serious difficulty, for cattle in covered buildings ought not to produce more liquid than can be sopped up by their litter, and carried away in the form of solid manure. Drainage is very properly insisted upon as a necessity, but a well-bricked floor supplied with litter, and cleared out daily, certainly gives little indication of surplus wet requiring an outlet.

The adaptation of old buildings to modern practice is an interesting problem. We have seen how a large barn may be converted into a commodious cow-shed, but there are many other cases in which a roof and four walls constitute a capital basis for various other buildings suitable for loose-boxes, hospitals, calf-houses, poultry-houses, implement sheds, silos, etc. Many old homesteads are highly picturesque, and it is some advantage to convert them by means of internal changes without introducing discordant elements.

**Extemporized Buildings.**—Yards and sheds are often required in outlying fields, and it is an advantage when they can be easily transferred from place to place. A straw yard for dry cows or for young stock may be well placed for roots and fodder one year, but

difficult of access the next. Permanent buildings are therefore seen to be open to certain objections which are met by placing a temporary yard and shed exactly where they are needed. We therefore throw out a few suggestions which are within the scope of tenants, involve little expense, and promote economy with regard to labour.

A *straw yard* should be placed near water, and on sloping ground, so as to avoid flooding in wet weather, or from melting snow. The site should be protected from wind by straw ricks, and supplied with roots and fodder. To these ends both corn and hay should be ricked near the site of the yard; and when the corn is thrashed the straw should be disposed in long ekes so as to cut off the north and east winds. A letter L arrangement will serve this purpose well, and the straw ricks should be securely thatched. On the lea-side of these ricks posts and rails are used to form a yard or yards; and cribs and water-troughs are sent up to furnish them. A comfortable covered shed is made by cutting out a roomy bay in the straw rick, and supporting the straw roof on rough timber and vertical poles, fixed in the ground. The construction is simple and well within the skill of ordinary farm hands, and the result is a perfectly comfortable shed and yard, in which cattle may be wintered as well as in any brick-built and tiled building. The cost is amply repaid by the saving effected in carting during the busy harvest season; and also in carting roots, fodder, and manure at various times. The warm and comfortable character of these extemporized buildings is at once appreciated upon entering them during a blizzard, and sheltering under the straw shed.

It may be objected that these yards are open to the rain, but on the other hand there is scarcely any roof water, and the amount of water which falls upon them may be measured by the rain-gauge. Cattle always look well in them, and are free from disturbance or risk of infection.

Not only can cattle be wintered, but pigs may be fattened in these straw yards in large numbers. The fence in this case should be further strengthened with firmly planted wattled hurdles, and the pigs roam through the littered yards, and lie under the shelter of the straw rick, into which they burrow. Locked bins containing meal, and a water-cart and buckets, are placed near at hand; and the troughs are arranged inside the enclosure.

The feeder visits the yard two or three times a day to replenish the troughs with food, and the pigs are contented and healthy. By this system straw may be converted into manure at any required distance from the homestead, and poor land may be brought into a high state of fertility. The lambing-pen is only another example of a system of extemporized yards, showing that they may be adapted for cattle, pigs, and sheep.

**Cost of erecting Farm Buildings.**—Substantial stone or brick-built and tiled buildings, fitted with modern appliances, may easily exceed ordinary estimates as to cost. It is necessary to arrive at the cost per acre, as well as that of the buildings, but it is evident that a set which would be suitable for 400 acres might also do for 500. In some cases the cost is extremely difficult to estimate, as it may include road-making, tree-planting, and fittings of an elaborate order. If, however,

we take an ordinary well-built farmery as designed by Mr. H. Munro Cautley for the *Standard Cyclopædia of Agriculture*, suitable for 400 acres of land, the estimate is about £2,250, although it might be very largely reduced by employing wood on brick footings to most of the shedding, and corrugated iron or some other cheaper substitute, instead of slates or tiles. Taking the estimate as it stands, it works out to £5 10s. per acre. The cost of isolated buildings may be arrived at by cubing the contents. Thus a building 40 feet long, 15 feet wide, and 10 feet average height, might cost from 1½*d.* to 3*d.* per cubic foot, according to the materials used—the figures working out to from £44 3s. 4*d.* to £75. Some of the buildings to be seen on model farms and dairies are fitted with electric light, marble floors and vessels, costly china, and brass mountings. The cow-stalls are sumptuous, and the total outlay almost incalculable. Scrupulous cleanliness, abundance of pure water, freedom from germs, uncontaminated air, and an equable and cool temperature are the objects to be aimed at in a dairy, and can be obtained with encaustic tiles, or even white-wash, red brick and slate slabs, non-porous floors, a thatched roof, a northern exposure, and shade from trees. An abundant supply of cold well-water from an uncontaminated source is important either for cooling milk or washing vessels. Many farm buildings are expensively fitted and entirely under cover, but, however good a roof may be for fattening cattle and for milking sheds, it is less desirable for store stock, and undesirable for show pigs. Cattle love to stand out in the rain, and butchers often prefer steers from small open yards provided with sheds, to those from covered buildings.

**Fine Buildings no sign of Good Farming.**—The public are apt to pay too much attention to buildings, but it is no common thing to find fine buildings in a slovenly state, and surrounded by foul and badly cultivated land. It is also to be feared that they are often accompanied by expensive amateurish management, and an annual loss. There is in fact no relation between fine buildings and good farming, or even between good stock and sumptuous fittings. As already pointed out, some of the best cattle have been housed under thatch, separated from each other by slabs and old sleepers, and approached through miry yards.

The conditions of perfect health are fortunately simple, and realizable by the poor as well as by the rich. Good food and attention, fresh air and exercise, pure water, and clean straw are as easily supplied in simple buildings as in elaborate model homesteads, and are not always to be found even there. Sufficient has been said to show that we rather discourage fine homesteads, and on the whole prefer scattered buildings, either of permanent or temporary character.

**Unnecessary Adjuncts to Buildings.**—The modifying effects of the portable thrashing machine and the travelling chaff-cutter; of ready-crushed cake, and ready-ground meals have already been pointed out, but there are other complications of the past which are likely to disappear. There is for example the rick-yard, which is now left comparatively empty, in favour of stacking in the field. Rick-stands with vermin-proof pillars may be of use in keeping out mice and rats,

but, in order to be effective, they require much attention. Stack-props, heaps of rubbish, hanging straw, etc., admit mice and rats, and staddled ricks are by no means always free from them. Staddles are scarcely consistent with field ricking, and, as a substitute, we recommend early thrashing, and frequent dressings of ricks which are to stand the winter. Elaborate rick-yards may therefore be regarded as belonging to the middle periods of last century.

**Liquid Manure Tanks and Manure Sheds.**—Neither of these adjuncts have ever been appreciated by farmers. As to the first, covered buildings prevent the accumulation of liquid manure, and an adequate supply of litter ought to sop up the urine of cattle and enable it to be carted to the field. Manure sheds are inconsistent with the modern practice of taking the manure straight to the land, and applying it in the long state. They also point backwards to a time when farmers were recommended to mix the horse, cattle, and pig excrements together, to pump liquid manure over the mass, and to convert the whole into “well-made and well-rotted” farm-yard manure. These objects are now attained by arranging the buildings so that the horse litter is daily spread over a contiguous yard for young cattle; by allowing pigs to frequent the cattle yards or by daily removing the wet and soiled litter from cow-sheds or stables to a pig-yard, where it serves as bedding, and is further converted into dung.

**Cooking Apparatuses.**—Cooking food for live stock has never rested upon a sure foundation. It has received little encouragement from the veterinary profession as regards horses, and has not been widely adopted by cattle feeders. It is unnecessary for roots, cake or meal, and does not materially improve chaff. There are, however, certain directions in which cooking of a simple sort may be used with advantage, as for example for pigs, calves, and poultry. Boiled potatoes and steamed parsnips, mixed with barley meal and separated milk, form excellent foods for fattening pigs, and an apparatus already mentioned may be obtained at small cost which can be placed on a floor in a position where there is no risk from fire. It possesses a boiler as well as a steamer, and may be used for preparing linseed mucilage for calves, or for heating water for mixing with calf meals.

Poultry-keepers, too, in many cases believe in warm food as promoting egg production, and a bran mash is found beneficial for horses, brood mares, newly calved cows, and invalid animals. A boiler or steaming apparatus is therefore a useful adjunct to buildings, but it need not take the form of steam pipes leading from a boiler, and delivering hot vapour under heaps of chaff. A little cold water thrown over such a heap enriched with meals of approved character, will serve as good a purpose. Sufficient heat will soon be generated to permeate the heap, but it should not be allowed to remain long enough to become fusty.

**Stores.**—Secure and roomy storehouses have become of great importance to a modern farmer. They are not to be confused with the granary, but are provided with a good floor and bins for crushed cake, for meal, dried grains, and other foods. They are also the

repositories for duplicates of working parts of harvesters, reapers, and mowers, plough and cultivator shares, and land-sides; skim coulters and change wheels; canvasses, quarter bags, sacks, belts, oil, cart-grease, dressings for corn or sheep, and a host of other articles which are required at certain seasons, and are liable to be mislaid. Stores ought to be compact, two-storied, and well-lighted buildings, to which no one should have access but the farmer or his foreman. A special store for wool is also extremely useful where large flocks are kept.

**Implement Shed.**—A good implement shed is too often absent from a set of farm buildings, or is not sufficiently commodious. In these days it is particularly necessary for harvesters, reapers, grass-cutters, horse hoes, drills, manure distributors, seed barrows, sprayers, etc. Some of these may be better kept in the stores, and especially replaceable working parts, but many of the machines are large and ponderous, and need a shed. Some of them, it is true, may be placed in cart and wagon sheds, but in any case a length of shed ought to be specially devoted to implements, other than carriages. A span-roofed shed is often the most convenient, as the implements can be drawn out from either side if the shed occupies an open space.

**Hospital.**—There ought always to be a detached loose-box for any animal which appears to be affected with an infectious disease. This may be used for other purposes, but it certainly should be present for purposes of isolation.

**Ordinary Dimensions of Farm Buildings.**—As previously explained, a set of farm buildings usually takes a rectangular form. Stores and granaries may form wings or transepts on the north side as protectors from the wind; the central building will run southwards as a sort of nave, and may contain the barns and comprise a shed for cows under the upper barn in place of a lower barn. This building will be flanked with yards, and, if necessary, with sheds. The remaining buildings will form parallel lines of shedding, terminating on a south exposure, and will be fenced and provided with gates. The variations in the details of arrangement are considerable, but the buildings as sketched out will be comfortable and well sheltered, and the rick-yard and a belt of trees may complete the picture north of the stores and granaries.

Yards 30 feet wide by 25 feet, with a covered shed 30 by 15 (total space 30 by 40 square feet), will be ample for eight full-sized steers or a dozen stirks. They may be further divided by posts and rails if necessary, but the above dimensions will be found to fit in with the general design of a set of buildings. Cattle-boxes should be 10 by 10 feet and with 4 ft. feeding passage, and in double row may form a range 24 feet wide, and of any required length. Barns, granaries, and stores may be 18 feet wide; horse stables, 15 to 18 feet wide; cart-sheds, piggeries, and other offices of similar width, in order to keep all the buildings to the same general plan. Cow-sheds, if for a single row of cows, may be of the same width, and the length will be determined by the number of stalls, which will be made to correspond with the general design. If for a double row of cows the width of the building will be 29 feet, and should then occupy

a central position with regard to the yards (for dimensions see p. 332). Ordinary sheds for yards may be from 12 to 15 feet deep, and are supported on posts resting on brick footings.

Horse-stalls are generally 6 feet from centre to centre, and should slope gently towards the drains. Too great a slope fatigues horses, as it throws a constant strain upon their fore-legs. A loose-box is more restful than a stall, but takes up more room. Cart and wagon sheds are usually from 12 to 18 feet deep. Outside walls should be at least 9 inches thick. When exposed to vibration or the kicking of heavy horses the walls may be built stouter. Double 4½ in. walls, clamped together, are strong and warm, and are now much used.

*Calf-houses* may be 18 feet square, and divided into hutches 4 by 4 feet, or 6 by 4 feet by means of oak posts and rails with tiling laths nailed vertically, to prevent the calves from sucking each other through the rails.

**Weigh-bridge.**—Although not often included in plans of farm buildings a weigh-house is in accordance with modern ideas. It is useful for testing the increase in fattening animals, ascertaining the live weight of animals for sale, and for weighing produce sold or purchased, and also that grown on experimental plots.

**Materials used for Temporary Buildings.**—In fixing upon the best materials to be used for farm buildings it is necessary to consider the objects aimed at. Extreme durability is not always necessary, and it is well to remember that there are many buildings of a temporary character which the occupier can construct for himself without troubling his landlord. Such are field-yards, hovels, pigsties, and fowl-houses for setting down in pastures or distant fields. Some of these may be thought unworthy of the name of farm buildings, but they are often all that exists in that way on small holdings, and in many respects are equal in efficiency. They are seldom mentioned in books, and are unworthy of the attention of architects; nevertheless, they fulfil the essential conditions of a house, namely warmth and shelter. Their site also can be conveniently chosen, and they may take the form of extensions or adjuncts to buildings already in existence.

These "buildings", although possibly ephemeral, allow of repair, and may in this way be kept up for any length of time. They are easily planned, and are, like more permanent structures, rectangular in outline. A strong pile at each corner defines the area, and posts and rails pitched in straight lines between mark out three sides, the fourth being either entirely open or partly closed and provided with doors. The roof may be made of faggots or fern, thatched with straw, or it may be constructed of rough trusses and purlins covered with galvanized iron or other material.

Simple drains may lead to a barrel sunk in the earth, and it is probable that a garden is in close proximity for which the liquid manure will be useful.

Warmth is secured by a wall of slabs (outsides, from saw-mills) or railway sleepers set upright; and chinks can easily be stopped with grass or sacking. The appearance is neat, and the animals are perfectly happy. As to ventilation, it is easily secured by half-doors

and holes cut in the walls near the roof. Such buildings may be seen wherever there are cottagers and commoners. They are also to be observed on large farms, for colts and calves, and can be constructed with sheets of corrugated iron for roof and walls, but this material is less comfortable than wood and thatch. They are especially suitable for pigs, and may easily be extended so as to comprise space for shelves and bins. They are of course highly combustible, but this is an unavoidable contingency which should always be guarded against with the utmost vigilance. On the whole they are not in more danger in this respect than many other light structures of timber, and they seldom require to be visited after dark.

The materials used are very varied, and may consist of piles, rails, slabs, sleepers, iron, furze, faggots, straw, and fern. The internal fittings are mangers, racks, and troughs, and fattening pigs will be found to do well in them, as well as also brood sows and store cattle. They are easily adapted for cows, calves, horses, or colts, and there is no reason why they should not contain animals of considerable value.

*Mud walls* are largely used in the New Forest of Hampshire, and last a long time. They are seen around high-class gardens and often form the walls of dwelling-houses. They are built with a sort of concrete, and kept in form, while building, with flat boards raised as the stuff hardens. Mud walls should be provided with overhanging eaves to keep them dry, and in gardens they always carry a coping of thatch or slates. They are better resting on brick, as the lower parts are liable to be injured by driving rains. A wide and overhanging roof, however, keeps them dry above.

Weather-boarding is another light and cheap material which always looks neat. It is nailed horizontally on oak frames, and is easily renewed. The frames are practically everlasting, for many of them bear dates of a hundred years ago. Weather-boarding is an excellent material for any set of farm buildings, for it is suitable for barns and granaries, stables and cow-sheds. Like mud walls, these buildings should be protected by projecting eaves which throw off the wet, and should be tarred every year in dry weather, for nothing rots timber more quickly than painting or tarring while it is wet or sappy.

As to cost, it is probable that brick is as cheap as mud walls, but weather-boarding is always cheap, and many squares can be nailed to the frames in one day. The question of haulage is also important, for several thousands of feet of weather-boarding can be loaded on to a wagon. The thrift of our ancestors with regard to buildings is shown by the following case. It is that of a very fine barn in Hampshire, 140 feet long and about 28 wide, with bays, porches, and thrashing-floors, now used both for dressing corn and housing cows. The frame bears traces of having been entirely home-made, for the oak quarterings have evidently been fashioned with the axe, and the trusses and principals, the purlins and rafters, are all apparently of home growth, braced together with iron bands and strong nails. It stands on dwarf brick walls, and is closed in with weather-boarding. The roof was originally thatch, but is now tiled faultily, as the eaves have been scrimped, and the consequence is that the



weather-boarding rots prematurely on the weather side, and has to be replaced occasionally. This barn is more than a hundred years old.

**Thatch.**—Animals thrive well under thatched roofs. There is a prejudice against thatch on account of its harbouring birds and possibly rats, but it is much more durable than many people think. It is also considered dangerous for fire, and, no doubt, if it once gets alight it burns very rapidly. It is, however, curious to notice how many chimneys rise out of thatched houses without creating any thought of risk. There is much less chance of fire in farm buildings than in dwelling-houses, and practically none in the case of hovels and sheds in the open field. Thatch requires keeping up with half and quarter coats, and if attended to will last a lifetime, or longer. It is generally composed of wheat straw, but the best material is heather. It lasts a long time, and so far as appearance goes it is much prettier than slates or tiles. An allowance is made by assessment committees for thatched buildings on account of the cost of keeping them up. Thatch used to be very general fifty years since, and in Wiltshire whole farmsteads were roofed with it, and entire villages consisted of thatched cottages.

Lovers of the picturesque miss the thatch, but it is being superseded rapidly by other forms of roofing. Still, it deserves a place in extemporized buildings for live stock, and is not to be despised.

The object of the authors is to be of assistance to small-holders, and for those who aim at cultivation on a small scale and find a difficulty in equipping their land with buildings it may help them to learn that they can erect commodious and comfortable buildings with their own hands, and at very small cost.

## CHAPTER II.

### ENGINES AND FIELD IMPLEMENTS AND MACHINES.

ONE of the most important considerations on a farm is the motive-power. Steam is the most widely employed, and is in use in all parts of the world for driving machinery and working farm implements.

The different applications of the steam-engine include ploughing, thrashing, crushing and preparing grain, irrigation, etc.

**Types of Engines.**—There are three leading classes of engines in general use: the Portable, the Traction or Self-moving Road Locomotive, and the Stationary or Fixed Engine.

**Portable Engines.**—A portable engine consists of the engine proper combined with its boiler, the whole being mounted on road wheels. Connexions are provided for animal draught for moving the machine from place to place. The most usual type of portable engine is fixed over a horizontal boiler. For small powers, the vertical type of engine and boiler, mounted on a common base, is a convenient plant. High-power engines are provided with double cylinders. A further variety is the two-cylinder compound engine, which is certainly economical in running.

These engines are constructed in a number of sizes, ranging from about 6 h.p. and upwards, the size in most general use for driving thrashing-machines, clover hullers, maize shellers, etc., developing about 18 h.p. and upwards. When not required for thrashing, etc., they are utilized for driving fodder machinery, dairy machines, or similar duties; also very frequently for temporary work on the farm or estate, such as driving builders' machinery, sawing, pumping, irrigation purposes, etc.

**Traction-engines.**—The steam traction engine, or light agricultural locomotive (Fig. 157), bears a general resemblance to the ordinary portable engine. The traction-engine, however, is fitted with gearing, specially wide road wheels, and a number of other useful and necessary accessories, including self-contained water-tank, coal-bunk, steering gear, brake, winding drum, etc. These engines are used for driving and hauling thrashing-machines, for transporting agricultural produce, and for other agricultural purposes. They are also used for duties for which a portable engine can be employed. The sizes in general use are made to develop from 15 to 20 h.p. and upwards. They have to be constructed to comply with the requirements of the Light Locomotives Act, and travel at speeds of from 2 to 4 miles per hour on the road. They weigh from 8 tons in the smaller sizes to from 10 to 11 tons in the larger ones.

Of recent years a smaller and lighter type has been introduced, and finds much favour where less power is required. This engine is generally spoken of as a light tractor, and is licensed to run under the Heavy Motor Car Act. The limit of weight is 5 tons unladen, but they are permitted a maximum travelling speed of 5 miles per hour on the road. The maximum power developed by these small tractors is about 12 to 15 b.h.p. They are specially constructed for hauling light loads and for road travelling. They are, however, equally useful for driving any light machinery to which the foregoing types of engines are applied, up to their power limit. The small tractors are built with single cylinders, or alternatively with compound cylinders. The latter type is in more general use, and is said to be economical in fuel and water consumption, and is recommended for quiet running on the highways.

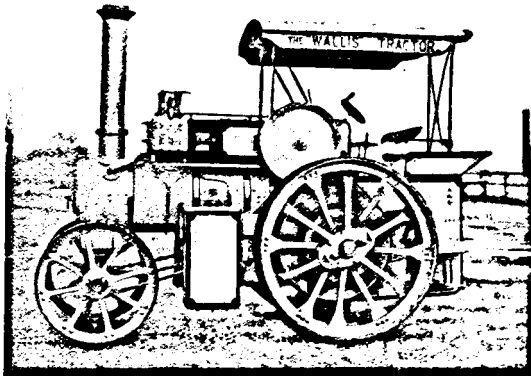

FIG. 157.—Steam Tractor.

Among traction-engines should be mentioned the ploughing-engine, both the type used for direct draught ploughing (Fig. 158) and what is known as the double-engine system, the latter being probably the better known in this country. These ploughing-engines are really modifications of the ordinary traction-engines, but are built somewhat heavier, and fitted with wider road wheels for running over soft land. They are also provided with a specially large winding drum and necessary disconnecting gear. These engines are worked in pairs stationed on either side of a field or stretch of land to be ploughed or cultivated. They are worked alternately, each engine in turn hauling the plough or cultivator in work by means of a cable and winding drum.

Ploughing-engines used for direct traction have come somewhat into favour of recent years, and are extensively used abroad, more especially in North and South America, and where the land allows of

the weight of an engine passing over it on unploughed or uncultivated portions. In construction they are similar to traction-engines, but special attention is given to the width of the road wheels, the attachments and fastenings for coupling up the ploughs and implements, and hauling. They are in a general way not quite so heavy as the engines used in the double-engine system of ploughing, and are without a special winding drum and rope.

**Stationary Engines.**—These are frequently installed for driving dairy machinery, grinding mills, crushing mills, turnip cutters, and other purposes in the barn or sheds. For dairy work the general type used is a vertical engine, combined with a vertical cross-tube, or multitubular, boiler. The boilers are frequently a size larger than necessary for supplying steam to the engine, in order to allow of steam being taken independently to other parts of the dairy for

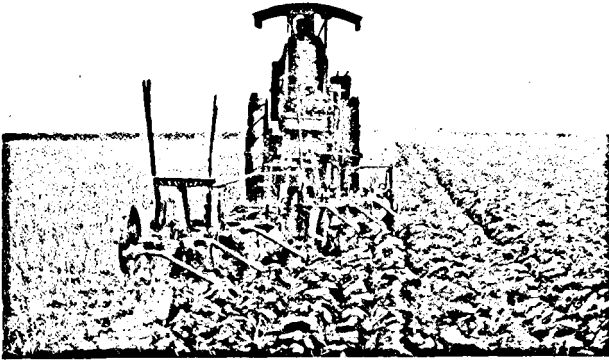

FIG. 158.—Steam Tractor drawing 6-furrow plough.

cleaning, scouring, etc. The exhaust steam from the engine or a portion of it is also frequently used for similar purposes.

Another type of stationary engine is the semi-portable, which is very similar to the portable engine, with the exception that the road wheels and axles are removed, and the engine is then carried on special frames and pedestals. Both the foregoing types are easily fixed, as they require very little foundation, more especially the semi-portable. It will be obvious that they are specially adapted for work of a temporary character.

Undertype engines are used in some cases instead of the foregoing. In this case the engine is placed underneath the boiler instead of above. The undertype requires very little foundation, and is strong, neat, and compact.

It sometimes happens that a small independent engine is required for driving machinery, the boiler for supplying the steam being already in existence, and probably at a considerable distance from the engine-room. In this case a vertical or a horizontal type of engine may be used. The latter has an overhanging cylinder, takes up but little space, and is suitable for running long periods without requiring any attention.

**Fuel.**—The fuel in general use is, of course, coal, and the boilers, as already mentioned, are provided with fireboxes and grates. In many cases, however, wood is the only fuel available, and the boilers are then built with specially large fireboxes for this purpose. In some districts where very common or bad coal is only obtainable, it is necessary to have large fireboxes to obtain the necessary combustion. Straw is also largely used as fuel, and many thousands of engines are to be seen in all parts of the world which burn nothing else. The boilers for this purpose have an enlarged firebox, but are generally fitted with a simple mechanical apparatus for feeding the straw into the firebox.

**Practical Engineering Knowledge.**—The student should first endeavour to make himself familiar with the simplest parts of machinery used on the farm, and also to become acquainted with their respective uses. Among these the following may be mentioned :—

*Bolts* are generally used in conjunction with nuts, for joining two parts together, both of which must be drilled with clearance holes.

A *Set-screw* is somewhat similar to a bolt, but with this difference, that, although used for joining two parts together, it is threaded right down to the head. One of the parts joined must have a threaded hole, and thus no nut is required.

A *Stud* has no head, and is employed to obviate the necessity of drilling a long hole through thick plates, which would be required if a bolt were used. One of the parts is threaded, the stud also being threaded at both ends and requiring a nut.

**Locking Devices.**—A bolt is described as “nobbed” when the small part, projecting beyond the nut, is burred over with a hammer. This method is unsuitable where nuts have to be frequently removed. A far more satisfactory method is that of using a split-pin, in which case a hole is drilled right through the nut and bolt, and the pin fixed into it. This method, although positive, and preventing the slackening of the nut, will permit of the dissembling of the parts, if desired. A split-pin may also be used in a hole drilled through the part of a bolt projecting beyond the nut. A castle nut, however, which has a slot cut beyond each hexagon, is the only really satisfactory way of using a split-pin for locking purposes. A spring washer, although not a positive method of locking, is very satisfactory for all ordinary work, and consists of one coil of a square-section spring.

**Casting and Forging** are terms used to distinguish parts of a machine, as well as the processes which they represent.

A *Frame* is that part of a machine on which all the other parts are assembled. Consequently when all other parts are removed the frame remains as a unit.

*Brackets* are used for supporting shafts or other parts on the frame.

A *Shaft* and *Spindle*, or *Azle*, differ in that the latter carries a moving part and is itself stationary, whereas a shaft revolves in bearings.

*Pulleys*, or *Sheaves*, and other parts may be fixed to shafts in several different ways. For rough work and where truth of the revolving parts is not important, the shaft is square and fits a square hole in the centre of the pulley. Another method is to cut a "key-way", or slot, in both the shaft and the pulley, leaving the shaft round and parallel. A "key", or rectangular piece of steel, is then used to fix the part to the shaft by being put into the slots. A jib-key is used when the pulley comes at the end of the shaft, and the jib of the key becomes useful when the pulley has to be detached. When it is important that a keyed part should run true on a shaft, the shaft should be turned taper, and a hole bored in the pulley to correspond. In removing a part which is attached to a shaft on a taper, great care must be exercised, and a removing tool is necessary.

*Bearings*.—A plain bearing is merely a hole cast, or machined, in a bracket, and when worn the whole part has to be replaced. A bush bearing is similar to the former except the hole is lined with some good bearing metal, and this lining can be replaced when worn. A split bearing is used when adjustment is necessary owing to rapid wear; care should be taken when adjusting this type of bearing that the shaft is not thrown out of line. Ball bearings are sometimes used in agricultural machines, and are of two kinds, the plain and the cone types, the adjustable or cone type being usually less satisfactory than the plain type. Roller bearings are similar in principle to ball bearings, but are wider and employ rollers instead of balls. Their chief defect lies in the possibility of a roller breaking. Ball thrust-bearings are a great improvement on any other type, and take end thrusts on the shaft.

*Methods of Transmitting Power*.—The motion of one shaft may be transmitted to another by means of a pulley and belt, and this method is quite satisfactory when the machine is under cover. The fact that a certain amount of slip may take place is an advantage rather than otherwise, as should the machinery jam, the belt will slip without doing further damage. In some cases ropes may be used in place of a belt, with grooves turned for them in the pulley.

A *Chain Drive* is employed when the shafts are some distance apart, and when the drive must be positive.

A *Toothed Gear* is used when the shafts are sufficiently close to one another, and are driven in opposite directions.

*Bevel* and *Worm Gears* are used when driving two shafts which are at right angles to each other.

*Double Helical Gearing*, where the teeth on the wheels are cut at a double angle, are used when heavy loads have to be transmitted with a minimum amount of noise.

A *Universal Jointed Shaft* is used when two shafts have to be driven which are not in line. It may also be used when the shafts are more relative to one another.

*Wheels.*—Wooden wheels are more expensive than those made of metal. If it is desired to make a strong yet light wheel, the spokes must be arranged in tension instead of compression. Wheels are often provided with curved spokes, as they are then less likely to break in cooling after being cast.

*Materials.*—*Wrought Iron* is easily bent without breaking, owing to all the carbon having been removed in its manufacture. It is easily welded and cut with steel tools, and has a tensile strength of 15 tons (i.e. the stress in tons it will bear per square inch).

*Mild Steel* is similar in nature to wrought iron, but usually contains from 2 to 3 per cent of carbon. In its cheapest form it has a tensile strength of about 20 tons, but this may be considerably increased if it is alloyed with nickel or other suitable metal.

*Cast Iron* is very brittle and soft, and contains a large percentage of free carbon. It is easily melted, and parts constructed of it are made in a mould with the metal in its molten state, which is then rapidly cooled. After casting it becomes very hard on the chilled surface, and in this form is used very largely for ploughshares.

*Cast Steel* contains a large percentage of combined carbon, and has the property of becoming extremely hard when rapidly cooled in water. In this form it is suitable for cutting tools and knives, such as are used for various agricultural implements. It is sometimes used in castings, when its great strength in the soft state is an advantage.

*Case-hardened Steel* is mild steel with a very hard surface section, varying in thickness to about one-eighth of an inch, and brought about by contact for several hours, at a red heat, with certain materials containing carbon. The case hardens when the part is quenched in water, and the soft inner core remains and imparts toughness.

*Brass* is composed of copper and zinc. Its chief properties are that it will take a high polish, and is non-corrosive.

*Gun-metal* is composed of copper and tin, is somewhat similar in appearance to brass, but is a good "bearing" metal.

*Tin* is a pure metal, very soft, and easily melted in a ladle, but when alloyed with antimony and copper it produces white metal of good bearing quality. White metal is sometimes known as anti-friction metal.

*Galvanized Iron* is ordinary sheet iron coated with zinc.

*Methods of Disassembling a Machine.*—All parts as removed should be placed carefully on the side of the machine from which they were removed, in boxes or in convenient heaps. Any part which cannot be so placed, the position of which is important when replaced, should be marked with a chisel or file. Before being taken apart great care should be observed in loosening any seized or tight parts, otherwise a breakage is liable to occur particularly where a cast-iron part has become fixed on a shaft or spindle. Paraffin should be applied liberally at the joint, and blows with a hammer only applied in conjunction with a block of wood. If this method fails, the part may be heated with a blow lamp, when it will usually yield. All parts that have been removed should be carefully cleaned with paraffin, and

great care should be exercised in replacing them to prevent the omission of any part. Any badly worn parts should be noted and replaced, or repaired, at the earliest opportunity.

**Lubricating.**—A knowledge of lubrication is essential for all who have to do with agricultural machinery. Oil-ways and passages should be protected by means of caps, as, when open, water, with dirt in suspension, will find its way into the bearings, and apart from causing damage itself, will tend to make the oil work outwards instead of inwards.

On land wheels, and other slow-moving parts, grease should be used and fed through suitable greasers, to which a removable cap, which cannot be easily lost, would be fitted. For self-binders and other complicated machinery more elaborate methods are necessary.

A number of bearings may be lubricated by one drip-feed lubricator, which usually consists of a small circular tank with glass tubes, so arranged that the passage of the oil may be observed, and which are connected by copper pipes to the various bearings. The drip from the tank may be regulated by a needle valve, and thus each bearing may be provided with the necessary quantity of oil, or, if need be, the aperture may be closed. Considerable economy of oil would be effected if the drip-feed were more largely used.

The syphon lubricator is used on machines of a still more complicated character, such as thrashing-machines and flour-mills. It consists of an oil cup, connected with a central tube, which communicates with the bearings, and a piece of cotton wool in the tube acts as a wick and draws the oil from the cup to the bearings. Care must be taken that the wick is always in place and not tightly wedged in the tube, so as to prevent the free passage of the oil.

The pressure system or force-feed lubrication is now largely used on all up-to-date enclosed engines, and still further emphasizes the importance of thorough lubrication.

**Mechanical Power.**—There are various ways of actuating farm machinery; and horse-gear, steam, gas, oil, or petrol may all be used for this purpose. Any of these primary motors being capable of driving shafting and pulleys. The shafting consists of a length of steel, turned true in a lathe, and running in either plain, bush, split, or ball bearings, and may be suspended from the ceiling or supported on brackets fixed in the wall. Ball bearings, although somewhat expensive, will save a considerable amount of power, and more than pay for the slight increase in their first cost. Moreover, they have a great advantage because when once fitted they may be left for very long periods, and they do not require lubricating with oil, but only with a small quantity of grease at long intervals.

Horse-gearing does not require much detailed explanation. It consists of a large caged or domed driving wheel on a vertical axle, which engages with a pinion wheel connected with a horizontal shaft. At the top of the driving wheel axle provision is made for the shaft or shafts to which the horses are attached. The power is transmitted to other machinery by means of clutches or an intermediate pulley, while if it is required to drive a number of machines overhead, shafting must be set up.



The steam-engine has many points in its favour for use on farms, and chief among them is its reliability. It may be overloaded, but will not stop from this cause, as oil- or petrol-engines do, which rely very largely upon speed for their power. Steam, moreover, is of no small importance on a dairy farm, where it may be utilized for cleansing and sterilizing dairy utensils, driving a turbine separator, and for steaming foods if required. On large farms, also, where a considerable amount of grinding, pulping, etc., has to be done in the preparation of foodstuffs, steam-power is quite equal, if not superior, to other methods.

Steam-engines and boilers have been brought to a very high state of efficiency in recent years, and require a minimum amount of

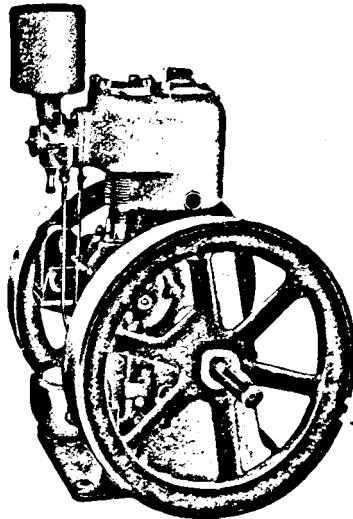

FIG. 159.—Vertical Petrol-engine.

so-called skilled attention. In fact, oil-engines often want more attention than a steam-engine would ever be likely to get, owing to the mechanical inexperience of those in charge of them. Another point of considerable economic importance is the fact that the cost of the necessary fuel for oil- and petrol-engines is very rapidly increasing, and may become prohibitive for agricultural purposes, so that it is quite possible that steam may once more come into favour, if only on account of the cost of fuel.

**Electric Power.**—Where a supply of electric energy is available, this form of power is extremely useful, and even economical. For instance, if a farm happens to be within the radius of a supply from a large power station, of which there are many in the country, a supply

of energy can be obtained from 2*d.* down to as low as  $\frac{1}{2}$ *d.* per unit, according to the quantity used per annum. Electrical energy at  $\frac{1}{2}$ *d.* per unit is undoubtedly cheaper than any other form of power.

Electric-motors have now attained a high degree of perfection, and are very reliable. They can be quickly and easily started, only consume current while at work, and only in exact proportion to the work performed, and thus there is no waste.

Considerable economy of space is also effected in that the motor may be fitted in any out-of-the-way corner—hung from the ceiling, placed on a bracket fixed to the wall, or on a platform laid on the rafters of the roof. They are always ready for instant service by day or night. A very great advantage of an electrical supply also is that lighting may be taken from the same source.

**Oil- and Petrol-Engines.**—These are of very great service in supplying motive-power for work of an intermittent kind, and the engines can be started in a very few minutes. There is no delay

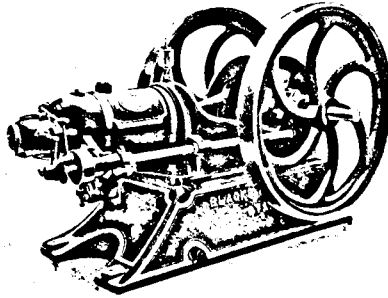

FIG. 160.—Standard Oil-engine.

of any kind, as in the case of steam-engines, nor is there any waste, for the engine stops promptly when the supply of oil is cut off. Ordinary lamp oils are generally used, including kerosene, petroleum, Daylight, Rocklight, and other well-known brands; most of these have a high flash-point and are not dangerous.

Chaff-cutters, root-pulpers, corn-grinders, winnowing machines, separators and other dairy appliances, the saw-bench, water-pump, and perhaps the grindstone, may all be economically driven by the small modern internal combustion engine. Oil-engines, it may be noted, are very similar in principle to petrol-engines, there being a water-jacketed cylinder, a piston, connecting-rod, crank-shaft, fly-wheels, and mushroom-shaped valves common to both, whilst recurring explosions in the cylinder are relied upon to supply the motive-power.

In detail these engines differ very considerably from one another. As a rule, a petrol-engine is vertical (Fig. 159), with an enclosed

crank-shaft, whilst an oil-engine is more often horizontal with exposed crank-shaft. The ignition also differs, that of the former being usually electric, whilst that of the latter is affected by a hot plate, and is called automatic. In comparing the advantages of the two, it should be noted that the oil-engine uses a fuel at about a third of the price of petrol, and, if anything, is simpler in construction than the latter; also it is easier to store large quantities of paraffin oil than of petrol without objection on the part of insurance companies. Here are some of the advantages of an oil-engine as compared with steam: a good oil- (or petrol-) engine of from 3 to 6 h.p. can be purchased at less than half the price of a steam-engine and boiler of similar power, the whole power plant of the engine is far more compact, in portable form it is very much lighter and handier, it can be started in a few minutes, whilst the steam-engine may require an hour. It produces no dust or ashes, and may be installed in a corn store, or loft, no washing out is required, and with a modern type of engine reliability is almost absolute.

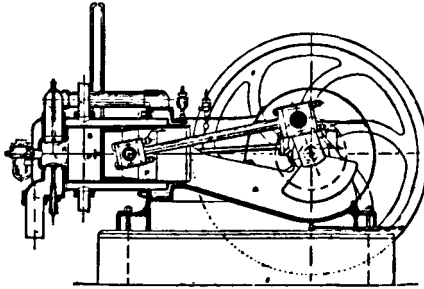

FIG. 161.—Diagrammatic Section of Oil-engine.

The most popular types of oil-engines (Figs. 160, 161) can be started in from seven to ten minutes, according to the size of the engine. First, the vaporizer, situated at the extreme back end, is heated to a dull-red heat by a coil lamp, and in about ten minutes time the fly-wheel is pulled round, which opens a valve through which air is drawn into the cylinder as the piston moves forward. On the piston moving backward this valve is closed, and the air in the cylinder is compressed and forced through the narrow neck at the back of the cylinder into the vaporizer. Meanwhile, a jet of oil is injected into the heated vaporizer and converted into vapour, which mixes with the air forced in by the piston to make an explosion. This explosion thrusts out the piston and the products of combustion follow into the cylinder, and on the return stroke of the piston a valve is opened and these products are forced into the exhaust pipe. The engine is quite automatic in action, the heat generated by the explosion and the compression being sufficient to keep the vaporizer hot, while there is no need for a continually burning lamp or an electric sparking apparatus.

Some oil-engines require no lamp for starting. Low tension magnetic ignition is employed, and this type of oil-engine is made in both the vertical and horizontal forms to suit the wishes of customers who prefer one or the other. Other engines can be started in from five to ten minutes from cold, and run with equal economy on a full or a small load. *Heavy fuel oils*, such as Texas, Scotch Shale, etc., may be used on the crude-oil engine (Fig. 162), which works on the spraying principle. A charge of fuel is injected by compressed air directly into the combustion chamber at the end of each compression stroke. It may here be noted that the cost of the heavy type of oil fuel is rapidly getting beyond all reasonable limits, and should this continue, petrol, paraffin, and crude-oils will be much too expensive for agricultural purposes, and farmers will have perforce to fall back upon steam.

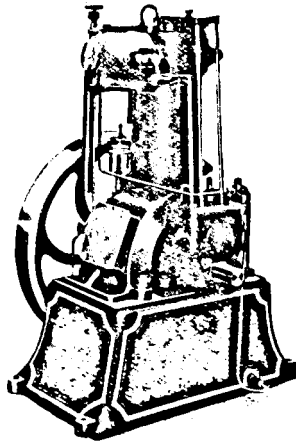

FIG. 162.—Vertical Petroleum Engine.

In studying the installation of an oil-engine the following points should be noted: economy does not lie mainly in the first cost; durability, low fuel consumption, and saving of labour are three of the main things to consider, besides the initial cost, for often the cheapest engine in price may prove to be a very dear one in the long run. Good material and good workmanship are essential, otherwise there is likely to be a heavy bill for repairs. Every particle of fuel should be used to generate power, and in the ordinary commercial engines the consumption of oil usually varies from two-thirds of a pint per b.h.p.<sup>1</sup> per hour in the larger engines to about 1 pint in the smallest. The engine must be simply and easily

<sup>1</sup> Brake horse power.

managed, so that skilled labour is unnecessary, and there should be no part which requires frequent regulation or watching. Once an oil-engine is started it will continue to run as long as there is oil in the tanks and lubricators, and often they can be left alone all day and sometimes all night to do their work without the least attention.

Steam Ploughing and Cultivating are commonly practised, especially where ground has become foul and is likely to benefit from summer fallowing and cleaning. Many farmers, however, systematically steam-plough or cultivate their land in order to plough up pans and to facilitate drainage. Care must be taken not to bring undesirable



FIG. 163.—Wind Engine pumping water.

subsoil to the surface, and this is where the Derby digger has an advantage, the soil being stirred by means of disks. This type of implement, however, is now rarely seen, as, like many other heavy travelling engines that pass over the soil, it is only in exceptional circumstances that good work can be effected, as, for example, on light soils during dry weather, when after sheep folding a good preparation can be obtained for the winter crop.

Double sets of engines are now very largely used for steam ploughing, in which case one engine is placed at either end of the field, the plough or cultivator being hauled backwards and forwards through the soil by means of a wire cable, the engines moving along

the headlands as the work proceeds. Many different types of engines, ploughs, and cultivators are used, each of which possesses individual merits.

Motors in Agriculture are now very popular, and have attained a high degree of perfection. The motor-tractor can be used for a variety of purposes, and there is ample evidence of its economical use as compared with the heavier types of steam-tractors. On a large farm a considerable reduction is effected in horse and manual labour, to say nothing of the necessary stabling, feeding, and attention which horses entail.

Petrol is the fuel generally employed, but paraffin, kerosene, and alcohol are also occasionally used. Each motor has usually two cylinders, possessing inlet and outlet valves, water-jacket, piston- and connecting-rod and crank, as in ordinary gas- and oil-engines. During the first outward stroke of the cycle a mixture of petrol vapour is drawn into the cylinder from the carburettor through the inlet valves. Here it is compressed by the second or inward stroke, when at the commencement of the third stroke the mixture of vapour and air is exploded by an electric spark or other means. The pressure caused by the expansion or explosion forces the piston outwards, thereby performing the third or working stroke, and furnishing sufficient energy for the three other strokes in which there is no impulse. This energy is stored in the fly-wheel during the next three strokes of the cycle. The fourth and last stroke of the cycle consists of the expulsion of the inert products of combustion through the exhaust valves by the return of the piston.

Not only are these motors used for ploughing, but also largely for mowing and reaping, when they haul the necessary implements after them. For locomotive purposes the power is transmitted by means of chain, clutch, or single gearing from the crank-shaft to the driving wheels. In performing stationary work, such as thrashing, chaff-cutting, grinding, pulping, etc., the end of the crank-shaft is fitted with a belt pulley so placed as to be easily adjustable to the necessary shafting.

Wind-power.—The utilization of wind-power for pumping water by means of windmills or engines is undoubtedly economical, as, once erected, these mills or engines require very little attention, the cost being almost entirely due to depreciation and interest on the capital. There are two chief types of windmill, the European and American, the former being somewhat more cumbersome, the whole structure, including sails, shafting, gearing, etc., being supported by a fixed

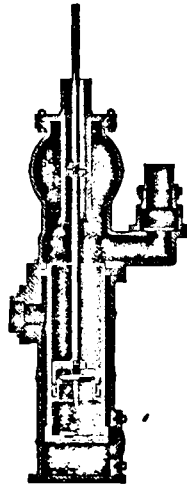

FIG. 164.—Section of Wind Engine Pump.

post. In the American and more modern types (Figs. 163, 164), the wind-wheel, gearing, etc., are all carried at the top of a high steel tower, and rotate round the head on ball bearings. The American machines are self-acting and governing, and are equipped with all modern mechanical improvements, and for many other reasons are preferable to the old European type, which require to be turned into position every time the wind changes. The small hind-wheel seen on every old windmill is provided for the purpose of adjusting the sails to the wind.

Water-power is in many cases available for fixed farm machinery. When it can be relied upon, it practically costs nothing and is used direct from the stream, which is dammed back for the purpose, or it may be conveyed by means of a duct. Water-wheels are either under- or over-shot, but the latter are most economical of water. Want of space prevents our entering upon the subject of hydraulic rams, but they also have been turned to account both for gardening and farming. So far as machinery is concerned there is no difference, for a mill or thrashing-machine can be actuated by water as well as by steam. It is a mere matter of power, and the weakness lies in the fact that water can only be successfully applied where there is an abundant and constant supply of it. The hydraulic ram may be used for raising and supplying water to buildings and for various purposes; and, as is well known, waterfalls are, and will be more and more, used for generating electricity. It is possible that both wind and water will be more used in the future than they are at present, now that electricity can be conveyed to any required distance.

#### FARM IMPLEMENTS AND MACHINES.

A practical knowledge of farm machinery and the use of the many implements connected with agriculture should commend itself to all who contemplate an agricultural career. To be able to instruct others and to know if the best possible work is being performed by any particular machine, with a view to economy of labour, oil, or fuel, as well as the minimum wear and tear of the mechanism, it is essential that those who are held responsible should acquaint themselves with the structure and management of machines entrusted to their care.

Equally important is it that youths who are serving an apprenticeship on a farm should themselves become familiar with the use of the simplest implements, and know what it is to complete a full day's work with those they are using, as without this intimate knowledge it is utterly impossible to successfully control manual labour.

For centuries little progress was made in improving implements of tillage, while during the past fifty years engineers have shown great ingenuity in inventing and bringing to perfection many kinds of machines with which to economize labour on the farm; and the various older types of wood and iron implements and machines have given place to others of lighter construction, in the manufacture of which steel is largely used.

**Tillage Implements.**—The plough (Figs. 165, 166, and 168) should certainly be considered first, as it is undoubtedly the most valuable and the most extensively employed of all agricultural implements. It may be interesting briefly to notice its ancient history, although such remarks may not be very applicable to its present form and capabilities. For instance, the children of Israel ploughed with two oxen (Deut. xxii, 10), their plough had a coulter and a ploughshare (1 Sam. xiii, 20), and they were aware of the advantages of winter fallows (Prov. xx, 4). It is certain that long ago ploughs were furnished with wheels. Nearly all the Greek ploughs had wheels, and although centuries have elapsed since these were the accepted type and most of them have disappeared, yet there are numbers of them still in use among the Hindoos and Chinese. In Markham's *English Husbandman*, published in 1635, the description of the plough is in very many particulars identical with some of the old-fashioned wooden ploughs used in Hampshire at the present day and drawn by oxen, but however interesting it might be to trace the history of the plough to the present time, our purpose is to discuss the principal parts of a modern plough and their functions.

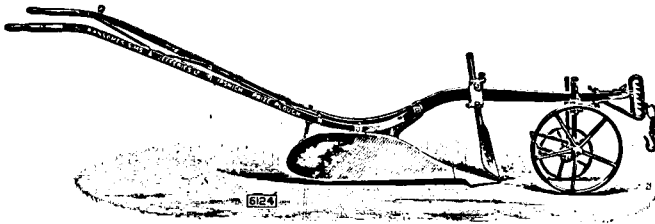

FIG. 165.—General Purpose Plough.

These parts (Fig. 167) may be placed under the following headings: Beam, Frame, Share, Turn-furrow or Breast, Slade, Coulter, Skim Coulter, and Wheels (one or two).

**Beam.**—The beam is the part to which the horses are attached, and terminates at the other end in two stilts or handles for the purpose of steering. For attaching the draft in front is a perforated T-shaped head, with the cross-piece curved, to which a sliding bar with a hake or head is attached and held in position by a pin fitting into one of the holes of the cross-piece. This admits of adjustment of the draft to the left or right as necessity demands, while the hake head, being provided with vertical notches into which the draft chain fits, allows the draft to be raised or lowered, so that by these means it may be regulated both laterally and vertically. With a wheel plough, however, the depth of the furrow is largely effected by means of the land wheel, the setting of which can be regulated so that if the plough tends to run too deep the draught may be lowered, or vice versa. The furrow wheel is used to regulate width, and always runs close to the land side of the furrow.



*Frame.*—The frame or body of the plough is attached or bolted below the beam, and carries all the component parts and draft attachments. It is in most cases made of cast iron, but for districts which are stony it is customary to make it of wrought iron or cast steel. It varies in size and shape, in keeping with the work to be performed, a deep frame being necessary for deep ploughing.

*Share.*—This is by far the most important part of the plough, and it is made of ordinary cast iron, steel, or chilled cast iron. The invention of chilling shares was patented in 1803 by Mr. Robert Ransome, of Ipswich. Before this time ordinary cast-iron shares were used, but the edge soon became too thick to cut the ground properly, and passed over weeds without cutting them. The invention consisted of case-hardening the under side of the share to the thickness of from one-sixteenth to one-eighth of an inch. This chilled part, from its hardness, wears very slowly, while the upper part grinds more quickly away, thereby maintaining a constant sharp edge. The share plays an important part in producing the form of furrow slice required, and cuts the horse-walk horizontally, severing

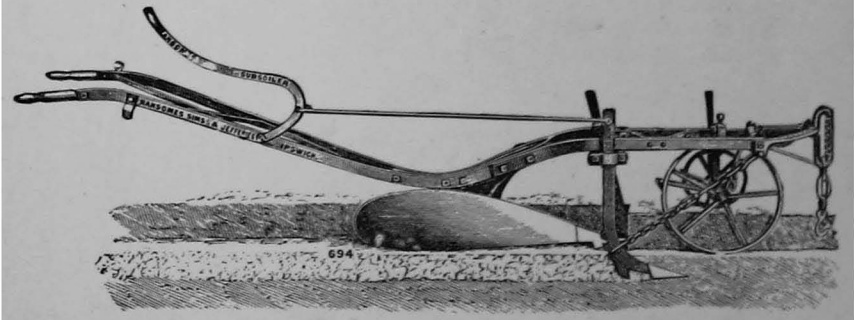

FIG. 166.—Subsoil Plough.

the slice from the under layer of soil. For easy cutting, a rather shorter share is used, while if the ground is hard or gravelly a long pointed share is used, and for skimming stubbles a very broad share does best.

*Breast- or Mould-board.*—The breast- or mould-board is made in an endless variety of shapes and sizes. A short, steep, sharply curved mould-board is used for stubble ploughing; and for furrows which are not required to be so much broken, a longer type with a gentle curve is preferred. The different types are almost legion, and the user must be the judge as to what suits his purpose. Mould-boards are made of steel, and when ground and polished are admirable for sticky soils; while if of ordinary cast iron they are more suitable for sandy soils. The chilling process, previously mentioned, has also been applied to mould-boards, and with great success in prolonging their lives. The process, however, is practically confined to comparatively short breasts, as it is practically impossible to preserve the shape of long ones treated in this way. Breasts for light, sandy, or medium soils should have a hollow or concave form, but for heavy

clay the surface must be longer and convex. Between these two descriptions an enormous number of different designs are used, and it

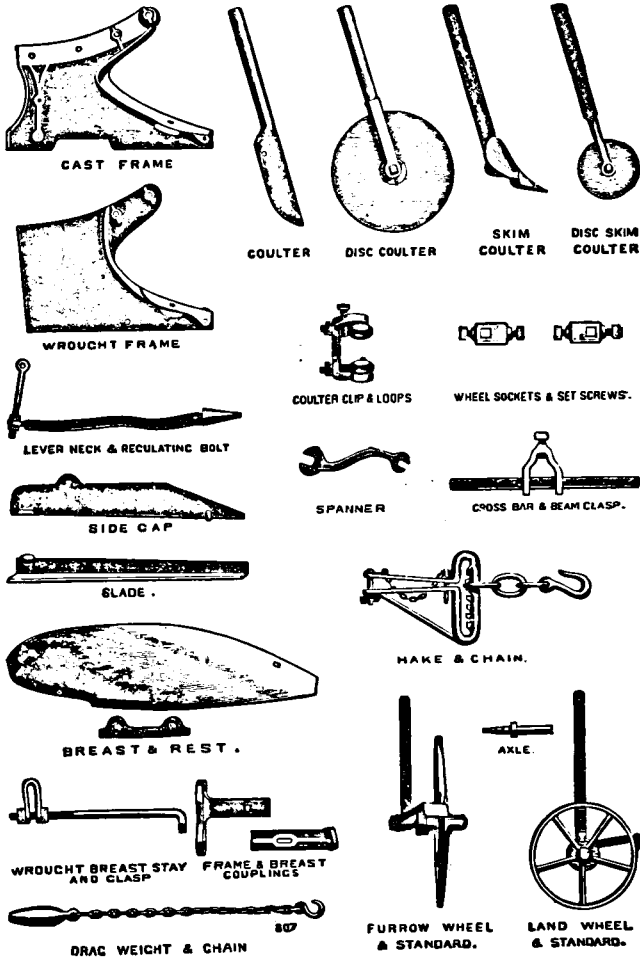

FIG. 167.—The Parts of the Plough.

is still no easy matter to determine which form is best for general purposes.

*Slade.*—The slade is an important part of the plough body, inasmuch as it supports the plough and keeps the “pitch” or “bite” of the share at the correct angle, and if it is not in order the share will not do its work properly.

*Coulter.*—The coulter is passed through a socket in the beam in front of the share and fixed by means of a clamp. It makes the vertical cut, separating the furrow slice from the unploughed land, and, simple as it may appear to be, much depends upon the coulter being properly formed and fixed. It is best to have its end or point about 1 inch from the point of the share vertically. The angle at which it is set is usually about  $60^\circ$  to the ground, in sticky land about  $75^\circ$ , and in trashy or brashy soil it should be set nearly vertical.

*Skim Coulter.*—The skim coulter is a plough body in miniature, and is placed slightly in advance of the coulter. It is used on

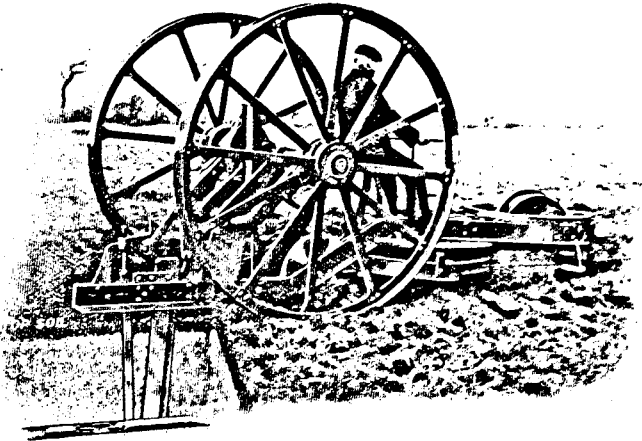

FIG. 168.—Mole Plough for forming a channel in the subsoil to drain the land.

lea lands and where there is loose manure or other material on the surface which requires burying. A draft chain with weight attached is also useful in dragging in long weeds and manure or stubble.

At the present time ploughs are used in three forms, namely, swing ploughs without wheels, ploughs with one wheel, and ploughs with two wheels. There are times when swing ploughs are very useful, as, for example, on undulating or grippy land when the depth of the work can be varied by pressure on the handles. By the addition of one or two wheels, when the land is level, the work is made much easier for the ploughman, and does not require so much skill as a swing plough. The smaller wheel is called the land wheel, as it runs on the unploughed land and assists in regulating the depth. The large wheel, or furrow wheel, runs in the open furrow and helps

to keep the plough upright and to regulate the width of the furrow. Assuming a complete plough, it may be set as follows :—

1. Raise land wheel to the depth required, which is generally marked on the upright stalk ; if it is not so marked, the depth of the ploughing is equal to the vertical depth from the bottom of the wheel to the point of the level of the share.
2. Place furrow wheel to the width required, which is generally marked on the cross-bar ; if it is not, then it is the distance from the land side of the share to the inner edge of the furrow wheel.
3. Adjust draft while ploughing by regulating the setting of the land wheel.

When proceeding to assemble the parts of a plough which is in pieces, they should be attached to the frame in the following order :—

1. Put lever neck into frame and screw up tightly.
2. Attach slade, frame, and breast couplings.
3. Fit share on to nose of lever neck.
4. Attach breast, and connect up couplings.
5. Fix breast, adjusting stay connecting breast and handles.
6. Fix side-cap or side-plate.
7. Adjust wheels, coulter, hake, etc.
8. Adjust as shown above.

Disk coulters are sometimes fitted in place of the ordinary type when the soil is very weedy or trashy, or, in fact, on any foul land. They cut the weeds away and enable the mould-board to turn the trash in. They must not, however, be used on stony land.

Double-furrow (Fig. 169) and multiple ploughs have advantages over the single-furrow type as they economize time and labour, while the draft is lighter than the combined draught of two single-furrow ploughs doing the same work. They are not, however, adapted for heavy retentive soils, where three and sometimes four horses are frequently required to perform satisfactory work even with the single-furrow plough. On light upland farms, such as are common in Hampshire and other southern counties, the double-furrow plough is now extensively used over large tracts of land folded with sheep, to be followed by the shallower rooting cereal crops. Where coarse, weedy stubbles, or ground dressed with long manure are to be ploughed, this can only be effectively performed by the single-furrow plough.

*Cultivators.*—Few implements employed in working the land have shown so much improvement in recent years as the cultivator (Fig. 170), which formerly consisted of inefficient stirrers, known as scarifiers, scufflers, or grubbers, mounted on heavy frames, and necessitating much labour to draw them through the ground.

The newer form of cultivators have light, steel frames with sickle tines (Fig. 171) capable of penetrating even the hardest ground, and affording that vibratory motion so beneficial in stirring soil that has become stale or impervious to air. No implement has done more to economize the working of land than the modern cultivator, as it can be readily converted into a steerage horse-hoe or a three-row

ridger, in addition to being useful as an ordinary cultivator and broad sharer.

It is customary to use the cultivator in stirring stale furrows in spring, where after autumn ploughing they have been subjected to winter rains, and cannot dry out readily until moved. It is often preferable on heavy clay soils to cultivate them well in spring instead of giving a second or cross-ploughing, as there is then less risk of

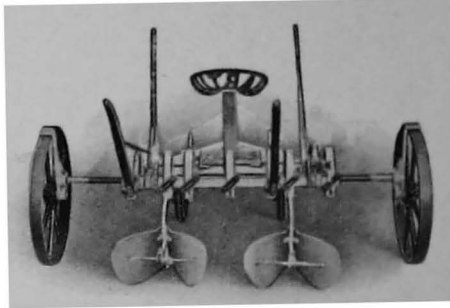

FIG. 169.—Double-furrow Ridging Plough.

bringing unweathered soil to the surface, which at that season bakes as hard as a brick, thereby preventing the formation of a good tilth.

Heavy wheel-cultivators are still to be seen on many farms, and where engaged in skimming, or for a deeper movement of the soil, require four good horses to draw them, there being no springing movement to counterbalance the friction to which the tines are subjected.

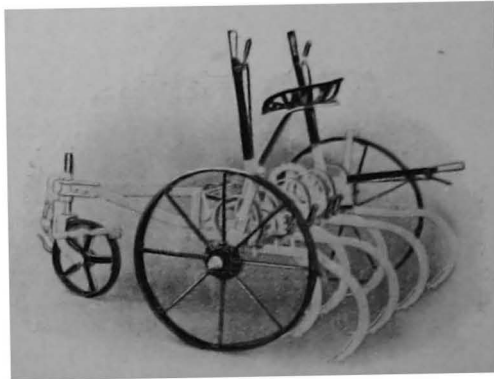

FIG. 170.—General Purpose Cultivator.

The student cannot do better than make a careful study of the many types of cultivators exhibited at the principal shows, as practical engineers are usually present and are always willing to explain the merits of any particular machine. Cultivators which combine ridging, horse-hoeing, and skimming are extremely useful on small farms where cost of equipment is an important consideration.

It will be noticed that the sickle-curved tine not only forces its way through the ground, but causes the moved soil to ride up the curve, thus retaining the fine soil on the top and bringing couch to the surface, a point of extreme importance. For excessively stiff soil a more rigid tine must be employed, and for this purpose machines with a heavier frame and a smaller number of tines are employed.

In some cultivators spring pressure on the rear sections or frames gives largely increased penetrating power without loss of flexibility, the form of tooth-seat permitting the tines to be set at will, either to cultivate the surface lightly or to dig deeply into the ground. The tines have four different angles of work, and a change can be very readily effected. In some instances tines are projected beyond each side in order to cultivate or break up the wheel tracts, while some of the smaller cultivators, made expressly for small farms, can be fitted with a grain seeder, and so perform the work of broadcasting.

Another very useful implement for the small farmer is the combined skim and scuffle, the skim comprising a pair of broad steel

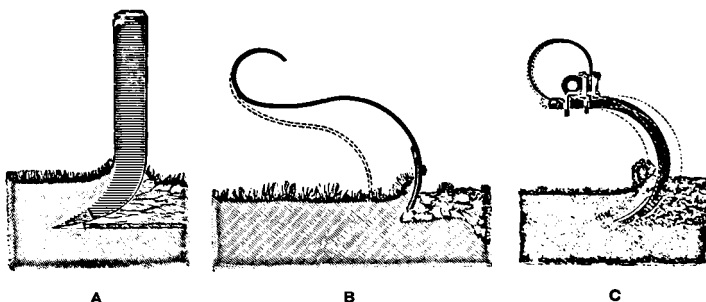

FIG. 171.—Types of Cultivator Tines. A, rigid tine—simply opens the ground without pulverizing it. B, spring steel tine—pulverizes the soil if previously worked, but liable to spring out of work. C, sickle tine—penetrates hardest soil and thoroughly stirs it with a vibratory action.

knives for paring stubbles after harvest, which can be simply removed and the frames converted into a scuffle by fixing the tines to the cross-bars.

In the best-grade cultivators the pole is made of wood with wood whippetrees, and neck yoke. The frame is of high carbon steel, well braced, heavy, and strong. The wheels, which should be of steel, are entirely within the frame, and can be moved along the axle to suit drills of from 22 to 30 inches apart. The standards and tines are heavy, and are adjustable sideways, up and down, and also for the necessary pitch. The steel points should be reversible, and 10 inches long by  $1\frac{1}{2}$  to 4 inches wide, according to the purpose for which they are required. The axle therefore does not come in contact with the tops of the plants when working in rows of roots.

*Clod-crushers.*—A clod-crusher is merely another term for a roller, as these implements only differ from the ordinary smooth cylindrical

roller in being composed of a number of sections or rings strung on an axle. The Cambridge, or ring-roller, is the type most commonly used, and answers all practical purposes, although in special instances better work may be done by a similar implement in which the rings are indented or notched, as these spike-like projections pierce the hard clods and force them asunder. When the surface soil has become baked and hard, and the lower layer remains of a dough-like consistency, it becomes impossible to perform satisfactory work with any kind of clod-crusher, as all that it does is to press the brick-like clods into the soft mass below, while, after the consolidation of heavy soils, the attempt to break surface clods has a disastrous effect. When used in conjunction with summer fallowing, there is less risk of injury than when preparing seed-beds in spring. The newer types of cultivators have done much to dispense with the heavy draft clod-crushers.

The common or smooth roller is generally used in the form of cylinders of from 10 inches to 3 feet or more in diameter, the larger cylinders being sometimes made to hold water, and thus admit of the pressure being regulated in accordance with the consistency of the soil. The object of using two or more cylinders in the construction of low wide rollers is to prevent the surface of the soil being disturbed more than is necessary when turning. A plain roller cannot be dispensed with on any farm, as it is essential for the sowing of grass, clover, and other small seeds. It is also useful for consolidating light soils, especially in spring where wheat and other crops requiring a firm seed-bed have been lifted owing to the loosening and hollowing effect of frost. Heavy rolling assists in checking the ravages of wire-worm among spring-sown crops. Shaftless rollers have much to recommend them, as they are more easily turned, and there is no risk of horses' shoulders being rubbed. Another good plan is the adoption of a scraper, which clears the roller of any soil that may cling to it as it passes over the land.

*Harrows*, like cultivators, have now been brought to a high state of perfection, combining efficiency with lightness and durability.

The principal types of harrows are : drag harrows with or without handles, light or seed harrows, the zigzag, flexible, chain and link, sickle tine, and disk ; there are also many modifications of these to suit special circumstances. In many of the lighter, or grass, harrows flexible frames have been successfully introduced, as, for example, in the familiar chain harrows, the whippetrees of which are now usually made of iron or steel tubing. A useful form of this harrow is constructed of cast-iron cusps, connected by wrought-steel links, they being longer on one side than on the other, and it may therefore be used either backwards or forwards or on either side, according to the state of the land. Others, again, are closely studded with short steel wire-like tines, which are extremely useful for collecting surface weeds, or even destroying the seedlings of charlock or other weeds on arable land in early spring. Most flexible harrows admit of being lightened by the removal of sections of tines from the rear. The effectiveness of these harrows depends largely upon their adjustability to inequalities on the surface of the land.

The cultivator and harrow are to the farmer what the fork and rake are to the gardener, the former being used for the purpose of opening up the soil early in the season, and the latter for levelling the surface and securing the necessary tilth for sowing. Drags, or heavy harrows, are, as it were, intermediate between the cultivator and the zigzag harrow. The drags usually follow the cultivator, or may be used to break down the furrow on lighter soils. The curved tine handled drag harrows are extremely useful for working down tough furrows, and can often be successfully followed by the cultivator.

Zigzag harrows are essential as seed harrows in the preparation of the seed-bed, and are now almost invariably made of iron, and are of different weights. They are so constructed that no two tines follow one another in the same groove. The tines pass through slots situated at the points where the cross-bars intersect. In some instances each tooth is adjustable, being provided with a self-locking and self-wedging clip. The harrows, of which there are usually

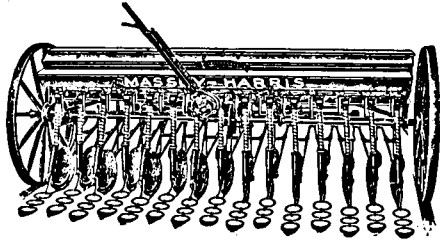

FIG. 172.—Disk Force-feed Corn Drill.

three, are attached to a draft pole on which is a draft chain to which the whippetrees are hooked.

Rotary harrows,<sup>1</sup> an altogether distinct type, are effectively used in breaking down furrows. Disk harrows are invaluable where permanent or temporary pastures are being broken up, as they cut the old turves and so facilitate drilling. Wherever old plantations or scrub are being brought under the plough the disk harrow will be found useful.

Spring wire-toothed harrows have teeth specially provided with sharp-cutting edges, while some have the appearance of a cultivator without wheels, the teeth being twisted. They are extremely useful in opening up ground that has become compressed and impervious to air. These harrows are also useful as light grass seed harrows, and for covering behind the drill on arable land. Many farmers still "brush" harrow their pastures in spring, which means taking a few strong thorn branches and tying them to an old gate, which is then inverted, and dragged over the ground to displace moss, distribute manure or other loose material on the surface. This work, however, is much more effectively performed by either a chain harrow, or, where moss is prevalent, with a wire-tooth harrow.

<sup>1</sup> Rotary harrows possess no actuating force or true rotary nature; they only swing round as they are pushed.



*Seeding Implements.*—The seed drill (Fig. 172) of the present day is as near perfection as it can well be in view of our present methods of seeding. The advantages of drilling are that it ensures the seed being deposited in the soil at uniform depths and at regular distances, while by adjusting the weights attached to the coulter the depth may be regulated so as to admit of very small seeds being sown shallow, and larger seeds at a greater depth. There are also many devices for covering the seed with fine soil after it has been deposited in the grooves made by the coulter.

Soil and climatic conditions are sometimes such as do not admit of drilling, as, for example, in the sowing of late wheat when the weather conditions are uncertain; and to avoid risk, the broadcaster keeps pace with the plough, a practice which ensures highly satisfactory results, as also does the ploughing and pressing of clover leas in readiness for broadcasting wheat or leas for oats, but conditions which suit wheat and oats are not equally adaptable to a crop like barley,

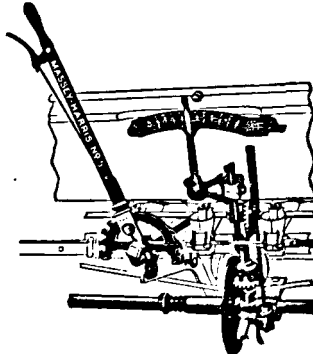

FIG. 173.—Force-feed Corn Drill Speed and Disk Pressure Regulators.

which to ensure an even sample demands a regular germination, and a regular distribution of the plants over the ground, together with a proportionate share of sunlight, a matter of less importance in the case of the other cereals.

The importance of regularity in drilling root crops cannot be over-estimated, as facilities are then afforded for cleaning by hand- or horse-hoeing.

In ordinary corn and seed drills the grain is lifted from the seed-box by cups, and conducted through flexible funnels, or down contracting and expanding steel tubes, or other devices, to cope with the inequalities in the surface of the land, and these terminate at the heel of the coulters, which is supported by long coulters levers hinged to a mortise bar at the front of the drill. The depth to which the coulter enters the soil is regulated (Fig. 173) by pressure by a spring, or by attaching weights to the coulter, while the width of the rows can be regulated by moving the coulters levers along the

bar, removing coulters with levers attached wherever necessary. Combined root and corn drills without steerage apparatus are never entirely successful when crops are sown which necessitate horse-hoing, as difficulty is experienced in getting the rows straight, especially where one horse draws stronger than his companion. Straighter drills can be drawn when a back steerage is fitted to the axle, more freedom being obtained by reason of the main parts being attached to the axle bar.

Most drills have a fore steerage carriage, but the shorter leverage of this, and the absence of a middle mark, make steering less easy. The travelling wheels in the majority of steerage drills carry the weight of the seed-box and gearing, and the quantity of seed to be sown is regulated by adjusting cog-wheels of various sizes. To enable the coulters to be lifted off the ground when turning, an adjustable pulley is used which also prevents the heavy coulters from sinking too far into the loose soil. By reversing the roller and tightening up

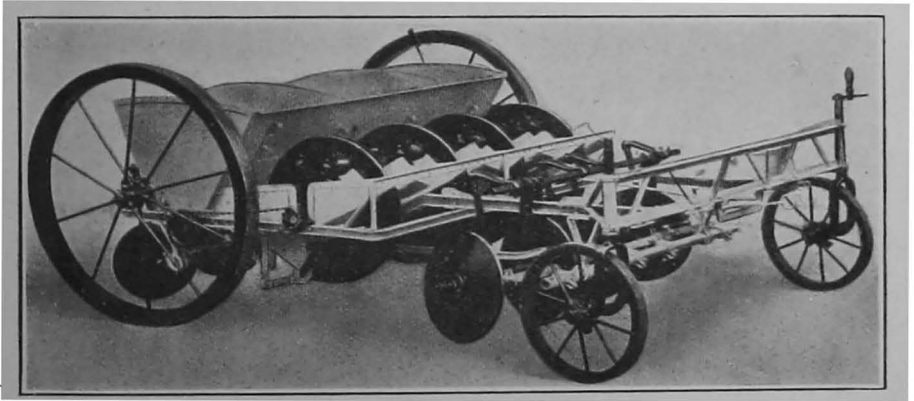

FIG. 174.—Potato Planting Machine.

the chains all the coulters may be pressed deeper into the soil. Excellent two-horse drills are made now with single-wheel steerage and markers.

There are many combined drills on the market, some being constructed to hold liquid manure which is delivered with the seed, but these require a very heavy draft; those which sow the manure in a powdered condition are less cumbrous. Disk drills are used where weeds and undecayed turf have to be cut through, and so prevent catching or bunching. In other instances coulters are reversible. The force-feed drill is a machine of light draft that can be worked by a man and a pair of horses. It indicates the exact quantity of seed sown and the area covered in a day.

In Scotland and the North of England, where turnips are sown on the ridge, a very distinct type of ridge drill is used for turnip and mangel sowing, as shown in Fig. 38. One-coulter hand drills are generally used for garden, and perform their work very effectively.

*Potato Drills or Planters.*—The expense entailed by the hand planting or dibbling of potatoes has resulted in several ingenious machines (Fig. 174) being devised for the planting of small or large areas, the majority of which embody the dredger principle. Another type of machine now extensively used is one wherein a number of cups attached to an endless chain lift the tubers from a hopper, and deposit them at regular distances in the rows. The width of the drills may be varied by readjusting the chain wheels fixed to the machine. It is estimated that a machine of this construction drawn by one horse, and attended to by a lad, will plant from 7 to 8 acres per day.

Small farmers who rarely want to plant more than an acre or so of potatoes will not require a drill for special work of this character, but where such machines can be hired an economy of labour will be effected, and the work of planting will be better performed. Especially is this so on heavy land where it is customary to plough in the sets.

*Horse-hoes.*—Horse-hoes are necessary for the cleaning of root crops; and the ordinary type of horse-hoe (Fig. 175) is often applicable

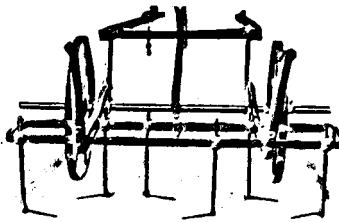

FIG. 175.—Three-row Horse-hoe.

for other crops, although different types are made. For example, a single-row hoe, or scuffler, is used for potatoes. There is also the steerage horse-hoe, in which a number of tines are fixed on a frame attached to a fore-carriage, and used for either roots or corn crops. Staked blades made in various widths from 4 to 20 inches are used according to the crop being dealt with. The lever horse-hoe is extensively used and the blades are carried on coultter arms hinged to a front bar, and these arms are carried beyond the point at which the hoes are attached to admit of their being weighted with adjustable weights to regulate the depth of the work. This type of hoe is preferable for shallow working. Either horizontal V or vertical L-shaped hoes are used; the former are preferable for moving the centre of the furrow, but the L shape is less liable to cut out the plants, as the wings point directly towards the furrow and their position may be noted better than in the case of the V shape. The latter, however, require slightly less draft.

**Harvesting Implements.**—When we reflect on the old sickle, it is no less than amazing to contemplate the great progress that has been made in haymaking and harvesting machinery. No manual operations demanded more strenuous labour on the part of the workers than did those associated with harvesting and thrashing, especially in the case of small farmers, who many years ago laboured by candle-light in the early hours of the morning with the flail, the then only available means for separating the grain from the straw and chaff. The thrashing-machine is now so perfectly constructed that much of the grain can be sold without subjecting it to winnowing or any other cleaning operation.

*The Self-binder.*—This machine (Fig. 176), of which there are now many types, has rendered the cutting and harvesting of corn a very simple process, and the excellence of the work performed leaves nothing to be desired. After being cut by the knives the crop falls

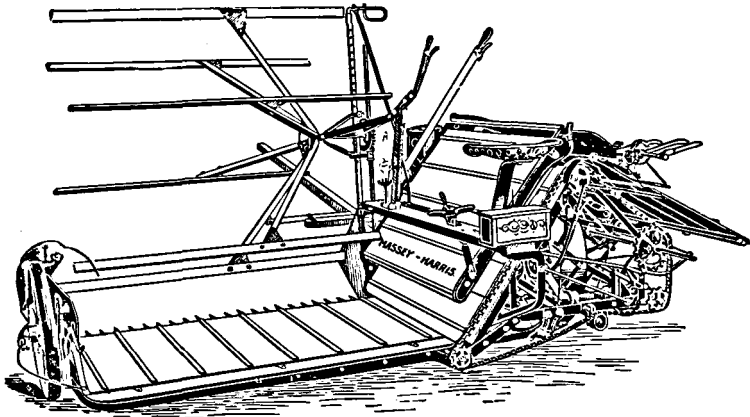

FIG. 176.—Self-binder.

upon a revolving canvas platform, and is finally passed between two other parallel canvases placed in a sloping position, which revolve on rollers, thus carrying the corn to the sheafing deck, where it is formed into a sheaf by means of packers, then bound and knotted by strong hemp twine at a given tension, and finally ejected on to the ground, or into a sheaf carrier (Fig. 177) by a simple mechanical contrivance. The manipulation of the canvases and reel is simple, but much skill is required in regulating the mechanism for timing the several actions involved in packing and tying the sheaves. Makers have, however, so perfected their machines that many of the old difficulties are no longer encountered.

The working of the knotter or tier (Fig. 178) is based upon the principle of the needle of a sewing-machine, and to understand its use, together with other parts of the machine, in order to be able

to repair a temporary breakdown in the field and to apply the necessary amount of lubricating oil economically, the farmer must study the construction of whatever machine he intends to adopt for use. Students cannot acquire this knowledge better than by being allowed to dissemble an old machine and reconstruct it under the supervision of a capable practical agricultural engineer.

Binders are carried upon a main travelling wheel (Fig. 179) having a wide sole or tyre, and a comparatively small wheel at

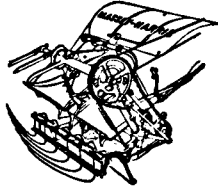

FIG. 177.—Sheaf Carrier for collecting sheaves ready for stooking.

the extreme end of the platform. The cutting apparatus, or knife, is usually 6 feet long, and is driven from gearing taken direct from the main wheel, and practically all the other movements are taken from chain gearing passing over a series of conveniently placed sprocket-wheels, while occasionally some of the motions affecting the sheaf and binder are transmitted by means of bevel-wheels through a spindle to the fore-part of the machine. Binders are now generally fitted with roller bearings which admit of considerably easier draft.

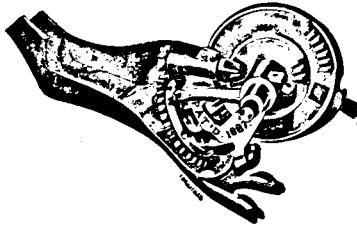

FIG. 178.—Knotter.

The various makers give full details of the respective merits of their machines, and fully illustrate the principal advantages in their catalogues, so that there is no need to further enlarge upon them.

The introduction and perfection of haymaking machinery has enabled farmers to deal much more effectively with large areas of cut grass than was possible when the greater portion of the work of drying and harvesting the crop was dependent upon manual labour, and considerably less hay is now spoilt through lack of strength at

that particular time when the dried grass must be collected and placed in bulk, and yet retain to the fullest extent the natural sap and constituents upon which so largely depend its quality and its value as food for stock.

*The Reaper and Mower.*—Those who have not had the opportunity of attending practical engineering classes and dissembling one or other of the principal types of machines would be well advised to procure a book of instruction, illustrating the various sections and mechanism of these machines.

There are now many forms of reapers, such as the self-raking reaper, the self-acting back delivery reaper, and others, some of which have steel platforms. Manual delivery machines cover little ground, are light in draft, and are specially suited for small farms or where crops are badly twisted by wind, or have become laid.

The reaper and mower have many points in common, but the latter is geared higher so as to effect a ready clearance, while on some reapers provision is made for attaching the hinged rack at the back of the cutter-bar, with a foot lever to raise or lower it so as

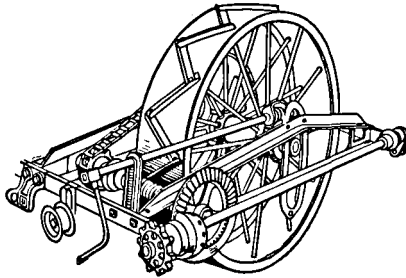

FIG. 179.—Main Driving Wheel of Binder.

to form the sheaves. While the operation of cutting is the same in both machines the frames are vastly different. The modern reaper, like the self-binder, has one travelling wheel, with a fixed and rigid cutter-bar necessitating a small travelling wheel so placed as to preserve the balance. The usual length of the knife of a mower is 4 ft. 6 in. as compared with 6 feet in the case of the binder, but other lengths are obtainable. The revolving rakes of the self-delivery reaper, while very effective in sheafing, are very exhaustive of power, especially if the corn lodges or drags, the arms of the rakes being driven from a standard placed of necessity at some considerable distance from the outer edge of the platform. In the modern type of self-delivery reapers the arm of the rake is much shorter than formerly, the capstan carrying the rakes being placed nearer to the heel of the knives, but notwithstanding this the draft is exceedingly heavy when a tangled crop is encountered, and may even exceed that required by an ordinary binder in cutting a crop that stands well up to the knives.

Mowers are made with both open and closed gears, and an arrangement for reaping is attachable to some machines, an ear lifter being fitted to the finger-bar above which is a rotating rack with tines, so curved as to keep the corn away from the knives.

*The Swath Turner.*—Among the almost endless variety of harvesting machines, the swath turner is undoubtedly one of the most important. By adjusting a lever the machine is made to turn the swath without breaking, in the proper direction so as to follow a left- or right-hand mower; to turn inwards to collect two or more rows into one, or to turn outwards or in opposite directions if required. The principle of the swath turner is that of rotary blades or prongs turning helically so that as the machine advances the ground below the swath is swept by the blades or prongs, on which the swath is lifted and turned over on to dry ground, two- or three swaths being usually turned at one and the same time.

*Tedder or Kicker.*—The hay tedder is a machine of more recent date, but considerable improvement has been made on the original types, which subjected the grass to very rough treatment, and made

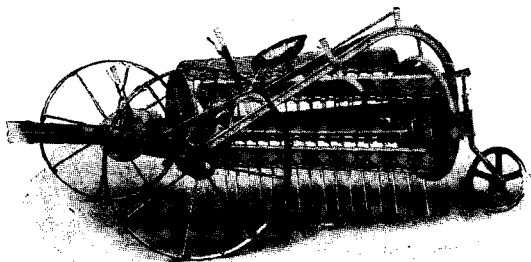

FIG. 180.—Combined Side-delivery Rake, Swath Turner, and Tedder.

it susceptible to more than ordinary damage in the event of rain falling. The use of hay tedders is more applicable for poor crops on the lighter soils of the South of England than on heavier soils in rainy districts, where, if the crop is heavy and is spread evenly over the ground, it does not readily dry.

Even among the lighter crops the operation of tedding or kicking is responsible for much of the loss of the shorter grass, and especially of the leaves of clover; but where a large area of ground has to be covered some sacrifice must be made in view of economy of time. Where the crop is entirely composed of clover, or other legumes, the tedder should not be used.

*Tedder and Side Rake.*—A machine combining a side rake and tedder (Fig. 180) has recently been introduced which, in addition to collecting the swaths and delivering the hay into windrows, also performs the work of tedding by reversing the direction of rotation of the rake or drum, thus causing the hay to be thrown up and scattered gently and effectively, the hay lying in two swaths.

*The Side-delivery Rake.*—The side-delivery rake (Fig. 181) has met with considerable favour. In the most approved machines the raking apparatus is placed in front of the main axle, so that the driver has full view of the working of the machine. The rake bars are carried out at an angle to the line of travel, thereby facilitating the movement of the crop sideways. The raking apparatus is suspended from the main frame of the machine, ensuring the rake teeth being always parallel with the ground in whatever position they may be raised above it. A lever admits of the rake bars being raised or lowered, and another allows of the machine being thrown in or out of gear.

*Swath Turner and Collector.*—These machines are made to turn or collect the swaths by means of a series of prongs fixed to an endless carrier, which circulates around two heads, one on either side of the machine, and which gather the hay into windrows. The frame of the machine is fixed slightly obliquely to the line of draft, and when one set of prongs comes in contact with the ground the others are slightly

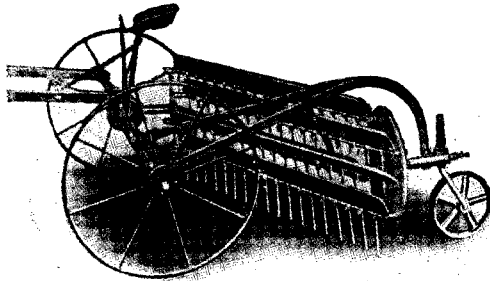

FIG. 181.—Ordinary Side-delivery Rake.

raised, falling into work again as they pass downwards. The most approved machines work equally well on ridge or furrow as on the level, and turn the crop by a brisk action of the prongs, in place of pushing or paddling it to one side as is usually done by the older types of machines. A modern machine will deal very effectively with grown through crops.

*Hay Loaders.*—The hay loader is attached to the rear of a wagon and embodies the principle of the ordinary straw elevator, its own travelling wheels supplying the necessary motive-power. The windrows must be made with judgment so as to admit of a steady flow of hay passing up on to the wagon. If the rows are too wide or the hay irregularly placed the effective working of the machine is interfered with.

*Hay Sweeps.*—The hay sweep is largely used on many extensive upland farms in Hampshire and other Southern Counties where it is necessary to build the ricks in the fields, as the width of the sweep is not adaptable for use in small fields or where gateways have to be



negotiated. The sweep consists of a wooden framework 14 feet wide on two wheels  $3\frac{1}{2}$  feet in diameter, with tines 10 feet long and 18 inches apart fixed to the frame. The more improved machines admit of satisfactory work being done on uneven ground, which was not possible with the older types of this implement. The use of the sweep enables light crops of hay to be very quickly picked up, the long tines running under the hay, which is pressed up towards the rear until the machine can hold no more, while to empty the contents the machine is run backwards and this allows the hay to slide off. By elevating the tines the hay can often be brought close up to the rick and thus effect considerable economy with both horse and manual labour, or if not sufficiently dry to put in bulk the hay may be placed in cocks ready for carting.

*Hay Stackers or Elevators* can only be economically utilized on large farms where a large acreage of land is laid up for hay, and where the ricks assume large dimensions, as is frequently the case with sainfoin, clover, and the coarser grasses from water-meadows. The expense of these elevators, the infrequency of their use, and often the inconvenience of storage or rapid depreciation in value when badly housed in winter, largely accounts for their being little used, although they can be used for corn and straw during thrashing, and may thus be in use all the year round. The use of the elevator undoubtedly relieves the men of a great deal of laborious work, the pitching of hay or corn being considered the most strenuous form of work upon which a farm-hand can be employed, but it rests with the farmer to work out the actual saving in money which its use will ensure.

The portable elevator, or clip-fork stacker, has now largely displaced older methods. Two youths, one attending to the horse and the other to the clip-fork, can usually keep four or even more pitchers on the field fully employed, so that there is little doubt that this form of elevating will gradually become more popular.

*Pyke-lifter*.—In the North of England, Scotland, and Ireland much of the hay is put up into "pykes" or miniature ricks, conical in shape, weighing from  $\frac{1}{2}$  to  $\frac{3}{4}$  ton, and the loading of these on to ordinary carts entails much labour, as the hay becomes well settled. The pyke- or rick-lifter is merely a sleigh-like contrivance, sometimes on low wheels, which is backed and tipped against the bottom of the pyke. The lifter is provided with a windlass with a rope or chain which is placed around the base of the pyke and wound up, drawing it on to the platform which is then pulled level. Special types of elevators are sometimes used for loading on to ordinary carts, or a tripod arrangement which is placed over the pyke, iron grabs with fork-like clutches being fixed into the bottom of the pyke, and a horse is attached to the tackle fixed around the base so that in pulling the pyke is raised sufficiently high for a flat cart to be backed beneath it to receive the load.

*The Horse-rake* is essential for raking meadows or stubbles after the main portion of the crop has been lifted. Its construction is too familiar to require any explanation. The fact must not be overlooked that the horse-rake frequently collects damp wads of grass,

which the wheels of the mower may have pressed into the soil and which have escaped the tines of the swath turner, also that these must be shaken out as they will turn mouldy or fusty if placed in the rick. Moreover, care should be taken to see that stones are not brought into the rick, as if so these will break the chaff-cutter when they are included with the hay for chaffing.

**Spraying Machines.**—No machines have been more improved of recent years than those employed in spraying, and all kinds of sprayers are in demand for a variety of purposes, such as spraying hops, charlock, potatoes, fruit-trees, and lime-washing. In nearly all instances an airtight compartment which contains the spray fluid is connected by means of a valve with an air-chamber in which air is compressed by a pump, so that when forced out of the nozzle of the machine it carries the liquid with it in the form of a fine spray.

In a Four Oaks sprayer, and other improved types, a small pump is fitted to the outside of the container, an outside air-chamber being considered more effective than the older type. No stirring is needed, as at each pump the jet is forced from the bottom of the liquid, and there are therefore no inside attachments.

Messrs. Strawson did much pioneering work in spraying, and invented a machine capable of dealing with large areas. These machines control a series of nozzles connected by rubber tubing through which the spray fluid is forced. The pump is worked either by hand, as, for example, when the container barrel is placed in an ordinary cart (see Fig. 69), or by gearing when a self-contained machine is used. Charlock or potatoes may be sprayed by the same machine, but in the latter case the nozzles are fitted with fauces, so arranged as to admit of the under as well as the upper surfaces of the leaves being reached.

In the production of milk under hygienic conditions the lime-washing of cow-houses by means of spraying machines has proved of inestimable value, and many firms have introduced portable sprayers specially suited for this purpose.

In some compressed-air spraying machines (see Fig. 67) very little time is lost in securing the necessary pressure, as much as 80 lb. per square inch being attained in about two minutes. Many machines are provided with pressure indicators.

As many machines made of copper were found to corrode, it became necessary to use two distinct containers, and this difficulty has now been overcome by the use of jacketed chambers.

**Manure Distributors.**—Several types of manure drills admit of either broadcasting or drilling, and are capable of dealing with all kinds of fertilizers. These drills are now less complicated than formerly, and in types like the Imperial (Fig. 182) at the bottom of the hopper there is a reciprocating steel plate, fitted with fingers, together with a galvanized steel platform. Revolving on this plate is a series of horizontal finger-wheels (Fig. 183), which, with the assistance of the finger-plates, carry the contents out of the hopper. The manure is delivered on to a spiked delivery board, which admits of its being perfectly distributed close to the ground. As there is no internal stirring, caking or clogging of the manure is prevented,

and spring steel scrapers remove any manure adhering to the finger-wheels before they return again to the hopper. The finger-wheels are readily released for cleaning by raising the pinion with spindles attached which drive them. The clutch arrangements and main drive wheel are actuated by a chain, while the finger-wheels and finger-plate are driven by worm gearing, which considerably reduces the draft. The speed of the finger-wheels is altered by a set of change

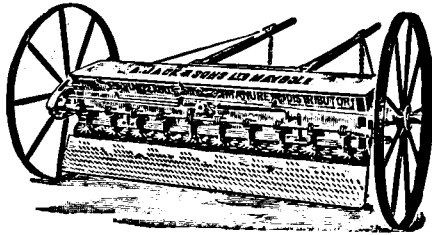

FIG. 182.—Manure Distributor.

wheels, so that the distribution of the manure may be varied from  $\frac{1}{2}$  to 25 cwt. per acre.

Disk-delivery manure distributors are largely in use, but work at a disadvantage during windy weather; while it is also less easy to distribute the manure evenly, owing to their centrifugal action, and in some types it is difficult to regulate the width of the sowing. Usually, however, coarser manures are thrown to a farther distance from the machine, but it must be remembered that fine manures,

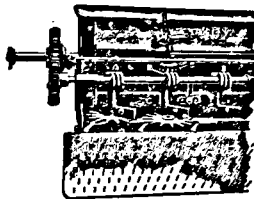

FIG. 183.—Section of Manure Distributor, showing :  
 A, finger-wheel and pinion in working position ;  
 B, pinion raised and finger-wheel partly withdrawn ;  
 C, finger-wheel entirely withdrawn for cleaning.

such as basic slag, are very easily carried by the wind. The machines are easier to clean than those fitted with chain or shaft deliveries.

The driving-wheels only actuate the feeder and spreader when moving in a forward direction, while the quantity of manure is regulated by means of an adjustable slide. In some of the more improved types the opening of the lid automatically cuts off the delivery of the manure. Where the spreader is of small diameter and

placed near to the ground, the distribution of the manure will be considerably more even than when it is some distance from the ground.

There are a great number of machines on the market, and the clogging of the manure and the difficulty in cleaning have always been great drawbacks. This, however, has now been largely overcome, the parts being easily removed for cleaning and possessing only a few of those bolts and nuts which give rise to corrosion. All manures of a sticky or pasty character are, however, best mixed with finely sifted soil to ensure even distribution.

*Dung Spreader.*—Dung spreaders find favour on many farms, and the machine practically consists of an ordinary wagon with a discharger fixed at the end, which distributes the manure in a fan-like sheet covering a wide stretch of the ground. The operation is controlled by a lever, and the application of the manure may be varied from five to thirty loads per acre. Where short manure is used the machine does its work well and economically, but these distributors

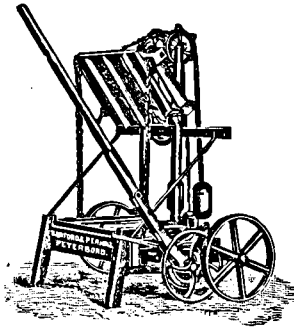

FIG. 184.—Hay Press.

are less suitable for the conveyance of the dung produced each day to the field. A considerable advantage lies in the fact that the distributing apparatus can be readily removed from the wagon, which may then be used for ordinary purposes.

*The Hay Pressers.*—A good hay press (Fig. 184) is a valuable acquisition on almost any farm, as its use not only considerably reduces the time and expense entailed in trussing, but also lessens the cost of freightage on the hay; pressed hay being conveyed at lower rates than that tied by hand.

The essential parts of the machine consist of a platform, to which a weighing apparatus is sometimes attached, and a ram actuated by a lever. The truss, as cut from the rick, is placed on the platform and weighed. The ram above is then let down and pressure applied by means of the lever, the hay being reduced to almost half its bulk (Fig. 185). When sufficiently contracted the hay is quickly tied with string and the lever lifted, when the ram admits of the truss being removed.

Hay presses in the hands of experts will dispose of as many as five trusses in eleven minutes, including both cutting and pressing. The press should be provided with road wheels and shafts for transport.

Root-thinners.—Root-thinners (Fig. 186) have been introduced within recent years, especially where the land is free from weeds. They may readily and regularly “gap” or “bunch” on either the

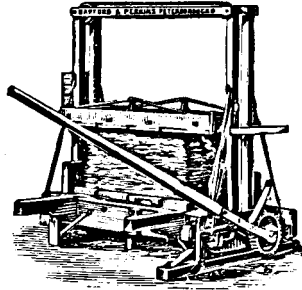

FIG. 185.—Hay Press in use.

ridge or the flat, but are scarcely reliable for actual singling. Neither can they be trusted where the plant is irregular, as the rotary action of the knives is uniform and may cut out plants which ought to be left.

Farm and Garden Implements include many instruments that are common to both departments. The spade is the only one, apart from

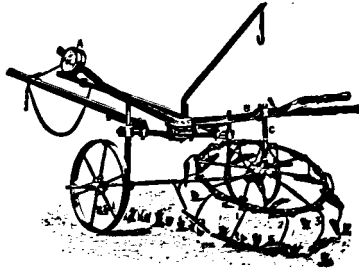

FIG. 186.—Root-thinner. A, counterweight to regulate weight on hoe; B, screw block for regulating angle of hoe wheel in conjunction with wheel stump; C, 1, 3, 8, 9 in. hoes in work, together gapping 12 in. between bunches.

the plough, which systematically inverts the soil, but it has the additional advantage of pulverizing it. The digging fork is used for a similar operation, but cannot be successfully employed on light soils. Inventors have from time to time endeavoured to embody the principle of the spade to farm machinery, for as yet nothing has rivalled the excellence of the work performed by the spade. This

fact is well known to gardeners, who when they wish for a well-grown crop of potatoes plant the seed as digging proceeds. There is all the difference between good and bad digging, and students should try and make themselves fully conversant with this important operation.

The hoe is also largely used, and, like the spade, dates among the very earliest implements used in cultivation. In fact, these two implements were the actual forerunners of the plough itself, which was originally drawn by men. In gardens the Dutch or push hoe is largely employed for weeding or scuffing until the crop has become well established.

The great advantage in its use is that the ground is left untrodden, as the hoer walks backwards, and consequently the weeds soon perish. There are many different types of hoes extant, some being almost entirely local. In Hampshire, for instance, frames are specially made into which new hoe blades may be fitted when the old ones are worn out. The common or draw hoe is chiefly used for heavy work and where strong weeds have to be dealt with. The head is given sufficient weight for the hoe to be assisted when driven into the ground, while steel adjustable blades are very useful in severing tough weeds, such as knotgrass. The potato hoe has a short shank and is also heavy-headed, as retentive soils often have to be loosened and broken up.

Half-moon shaped hoes have an advantage inasmuch as they do not collect the soil so much as those with square blades, while they assist in easier singling out of the plants. This type of hoe is usually made with what is known as a swan-neck. There are many forms of combined hoes, a useful type of which is the triangular hoe, so admirable for priming seed grooves.

Other implements include shovels, mattocks, grubbing axes, forks, turf- and verge-cutters, trowels, turf-beaters, hedging shears, pruning saws and knives, secateurs, scythes, hooks, spuds, while every farm and garden should always have its own chest of tools. The other necessary equipment will include wheelbarrows, water-barrows, water-cans, sprayers, and other utensils already familiar to the reader.

## CHAPTER III.

### CARTS AND BARN IMPLEMENTS AND MACHINES.

**Carts and Carriages.**—At the present day many firms specialize in the designing and construction of farm carts and wagons, and improvements are being constantly made. It is easy to see that the purpose of the farmer is much better met than was the case when this industry was left entirely in the hands of village wheelwrights, who used the same models that their fathers and grandfathers had left them.

The general purpose cart is suitable alike for the harvesting of crops, the carting of hay, hauling out manure, conveying goods of all descriptions to market, even to pigs, sheep, or calves. In an ordinary farm cart of the general purpose type the "ladders" should be removable, a perfect balance being maintained whether they are attached or not. Some simple but effective form of tipping arrangement is essential, such as will not allow of too much play. As regards the wheels, these must, of course, be strong and conveniently dished so as to afford easy running and a square even tread on the road. As a rule, the width of tyres on a general purpose farm cart ranges from 3 by  $\frac{5}{8}$  in. to 4 by  $\frac{3}{4}$  in. Vertical harvest raves can also be fixed on the ends of the ladders. Anything from 1 to 2 tons can be carried on these carts, according to the width of the tyres. With tyres 3 by  $\frac{5}{8}$  in. a strong one-horse cart will carry 20 to 25 cwt. ; 3 $\frac{1}{2}$  by  $\frac{5}{8}$  in., 30 cwt. ; 4 by  $\frac{5}{8}$  in., 30 to 35 cwt. ; and with tyres 4 by  $\frac{3}{4}$  in., a two-horse cart will carry 35 to 40 cwt.

Needless to say, a great deal of the value of a cart or wagon depends on the quality and seasoning of the wood. The shape and design vary in different districts. In hilly parts of the country, for example, a light spring cart is much preferable to the larger type of farm wagon. Local customs also play a great part in the design of farm carts. In Devonshire, for instance, types may be noticed quite different from those in common use in Scotland and Ireland.

Milk floats are usually made with bent or crank axles so that a low body can be built on them. This makes it easier to handle heavy churns and milkcans, and low-bodied carts of this type are also useful for carting heavy merchandise to market or to the station. Good springs are essential for carts of this type so as to prevent undue jolting.

Cattle breeders and exhibitors use specially designed carts, the floors of which are only a few inches off the ground. This enables heavy cattle to be loaded without much difficulty.

Farm wagons, drays, lorries, and trolleys are of many different types. Some are mounted on springs, and these are specially adapted for carting corn, potatoes, and fruit, or conveying sheep and pigs to market, the wheels being extra high so that the floor is about on a level with that of a railway van. Strong farm drays are also built without springs. Some of these have a floor-space of about 72 superficial feet, as contrasted with the 40 feet in ordinary old-fashioned farm wagons, and sacks can be loaded over the sides instead of only at the tail-board, while some admit of as many as 20 quarters of corn being loaded on the floor of the dray in an upright position. For carting hay and straw or any form of loose farm material, such as manure, lime, coke, coal, etc., the light hay drays are very useful, carrying from 2 to 3 tons. One of the latest types of farm carts is a combined form of cart and wagon. The front wheels and shelvings are attached to an ordinary cart in such a manner that they can be detached when required in a few minutes, thus converting the vehicle into an ordinary farm cart.

**Trucks.**—The introduction of traction-engines was naturally followed by trucks, adapted for conveying grain and other heavy materials in larger quantities than in carts and wagons. These are largely used by millers and to a limited extent by large farmers possessed of the necessary power, but they fall beyond the range of ordinary agricultural carriages.

**Thrashing-machines.**—Since the first revolving drum was patented by Meikle in 1788 the thrashing-machine has made steady progress, with the result that it would be almost impossible for the better types of modern machines to perform their work more efficiently than they do at present.

The thrashing-machine (Fig. 187) has a fascination for the majority of people, and most of us in our young days have gazed on it in wonder, and imagined, as well as our minds could admit, the various processes to which the grain was submitted, from the instant it was wrenched from the ear until it was returned through the slots at the rear of the machine. A knowledge of the essential parts of the machine is necessary for all who are entrusted with the thrashing of cereals or leguminous and other crops, the grain of which has to be separated from the other parts of the plant.

The large rotary steel and wrought-iron drum must first be mentioned, with its fixed fluted steel beaters. The drum is made sufficiently heavy to maintain an equal speed of from 800 to 1,000 revolutions per minute so as to ensure a perfect thrashing and to avoid breaking the grains. An open barrel concave partially encases the drum and is usually made of wrought iron in two parts hinged together. By means of three adjusting screws on each side outside of the machine the distance between the drum and concave can be readily regulated to suit the different kinds and conditions of grain. The gratings of the concave are formed by wires which pass through holes drilled in the concave bars.

The grain having now been removed from the ears or pods falls through the wires of the concave, while the straw passes along the shakers and falls out at the front of the machine, or passes through





a chaff-cutter (Fig. 188) ; the remaining material passes along to the cavings screen and is finally expelled.

The straw shakers are made on the reciprocating principle and are fitted with two crank-shafts, one at each end of the box, thereby giving a very evenly balanced motion and a vigorous alternative tossing action over the whole surface of the shakers. In order to further increase the separating power of the shakers, iron prongs are attached to the boxes, thereby assisting in separating the straw and extracting the grain. Steel check plates suspended over the shakers also serve to arrest any grain that may fly out from the drum, while also preventing the straw from travelling too fast along the shaker boxes.

The cavings riddle or upper shoe, together with the other shoes, is hung on ash hangers, which being flexible require no oil about their points of suspension. The cavings riddle is made in two pieces for convenience in changing it to suit all kinds of crops. A reciprocating board shakes back anything that falls on it to the

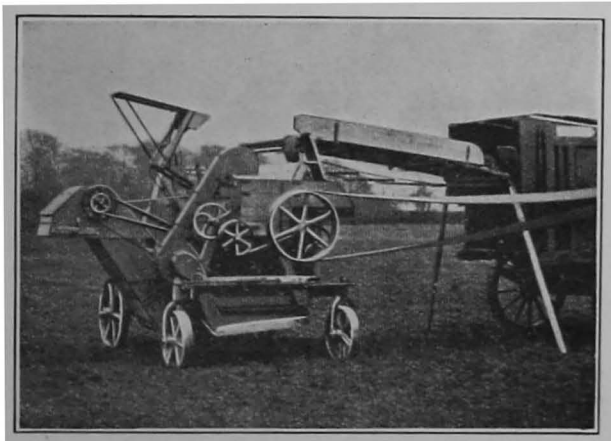

FIG. 188.—Maynard's Automatic Chaff-cutter attached to thrasher.

middle of the machine where it falls on to the riddle which reciprocates so as to sift it and remove anything that will pass through the holes, carrying the cavings and like material forward where they fall under the straw. The chaff and corn fall through on to the lower shoe, another reciprocating board, which works them toward the middle of the machine again, where they fall on to a series of sieves and encounter a dividing blast directed under the cavings riddle, which prevents any tendency to choke, and assists in the separation of the grain.

The lower dressing shoe is of larger capacity, and so constructed that the blast from the large fan passes underneath and through the chaff sieve. The lower sieve which receives the corn and chobs is extended outside the shoe, and has at the lower corner a small adjustable tail-board, which may be raised or lowered, while the

machine is running, to suit the quantity and nature of the chobs. The tail-board prevents the chobs from leaving the sieve until all the loose grain is separated.

There are two seed sieves to the lower shoe, the first placed in the upper part which serves to remove the seeds from the chaff before it is blown out by the fan and thus preventing the seeds from being redistributed on the land through the chaff, and the second in the bottom of the shoe under the corn sieve. The corn, having received its first cleaning when passing over the dressing shoe, is now precipitated down the shaker shoe into the bottom of the case enclosing the corn elevator to undergo a further cleaning process.

The corn elevator is usually of the bucket or dredger type, and so placed in the machine as to be free from injury. The cups or buckets are generally made of steel plate and are firmly riveted to the belt, which is wider than the cups to prevent the latter from rubbing against the elevator casing. The elevator is generally able to lift grain at the rate of 8 bushels per minute. The faces of the pulleys have gaps in them to prevent slipping of the belt.

The corn, having now been taken to the top of the machine at the rear of the drum, is there dealt with in another cleaning section where it passes into the awner or hummeller. The awner and chobber are arranged on the same spindle. The grain falls on to the screw which conveys it to the barrel of the awner where the knives mounted spirally around the spindle, revolve rapidly and effectually remove the awns from barley, and at the same time conduct the grain to the conical chobber, where it receives its first rubbing. The chobber may be used with six, three, or if desired without any knives or beaters, and yet being of conical shape will clear itself as effectually as when the knives or beaters are fitted in position.

By means of slides the grain may be made to fall direct into the sacks from the elevator, or it may be discharged into the second dressing shoe after passing through the awner barrel, but before entering the conical chobber casing. The second dressing shoe has two sieves placed one above the other, and the grain in falling through them is thoroughly cleansed of all dust, chaff, etc., by the blast from the second fan which plays underneath and through these sieves.

Wheat, or barley, which may have been insufficiently treated in the chobber and awner rolls over the ends of these sieves assisted by the blast, and is conveyed by the overflow spout to the first dressing shoe, where it is again dealt with and passes a second time through the awner and chobber. After leaving the second dressing shoe the rotary adjustable screen effectually separates all thin grain and seeds from the best corn. This screen is fitted with a revolving brush, which keeps the wires clear, and it has an inside worm which causes the grain to pass evenly along the screen. All those grains which are too large to pass through the screen are conveyed to the other end and fall into the corn spouts, thus constituting the best corn, while the thin or tail falls into the tail spout; those nearest the entry being the smallest or tail proper, while those falling later are known as seconds.

**Seed Dressers.**—The demand among farmers for pure samples of seed has resulted in the introduction of many effective seed dressers or cleaners, but these machines concern the seedsman rather than the farmer. The student can always see the dressers at work at the principal seed stores, when it will be observed that seeds of light weight, rough surface, and irregular shape are rejected from the more perfect sample, the latter being finally discharged, dressed, and purified. Seeds representing the worst types of weeds, such as docks, dodder, stoncrop, thistles, and many others, together with dross and dirt, are readily extracted from clovers and other seeds difficult to clean.

The fault of the older types of machines was that they removed a large proportion of good seed along with the weed seeds, thus entailing considerable waste; but nowadays, in many instances, as much as 1 ton of seed can be effectively cleaned in the course of a day by modern machines without any appreciable loss of good seed. No machine can effectively rid samples of peas or beans of seeds infected with weevils, or of damaged peas. These must be gone through by hand if high-grade samples are to be produced. The same remarks apply also to potatoes, but the fact that cereals, such as oats for example, can be freed from wild oats, clover from dodder and other destructive weeds, does much to reduce the subsequent cost of labour on the farm.

**Winnowing Machines** are essential in preparing samples of grain for market, although, as has been pointed out, some of the more improved types of thrashing-machines deliver the grain in a very clean and satisfactory condition. Winnowing, however, is always capable of further improving the sample and getting rid of the lighter corn. The structure of the winnower is so simple that it requires no description, as an inspection of it will soon demonstrate its working. An elevator is often attached to a winnower and worked by a strap from the driving-wheel spindle. It raises the grain by conducting tins as it passes from the machine into a hopper sufficiently high to admit of a sack being placed on a weighing machine underneath.

**Sheep-shearing Machines.**—For some years past the art of hand-shearing has been gradually superseded (especially in the Colonies) by the introduction of power shearing machines. Still more recently these machines have come into vogue in many parts of Great Britain, and bid fair to take the place of hand-work. They are simple in construction, being actuated either by hand, oil, electric, or steam power, and one clipper is stated to shear a sheep in two minutes. They are essentially developments of Clarke's horse-clipper, and are worked from a shafting which causes the rapid revolution of a spindle protected by a flexible tube. The accompanying illustration shows the general appearance of the machine and the principle employed (Fig. 189).

**Potato Raisers.**—The potato raiser (Fig. 190) has done much to reduce the cost of lifting heavy crops, and in the more modern types of machines the forks are so constructed as to throw out the tubers at the rear of the machine and without bruising or scattering

them too much, thereby facilitating gathering. By means of a lever the depth to which the forks work can be easily regulated. Years ago many potato growers imported Irish peasants during the harvesting



FIG. 189.—Sheep-shearing Machine at work.

season, but now the introduction of improved machines has rendered this practice no longer necessary.

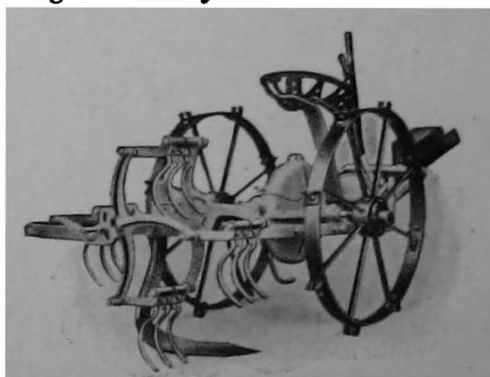

FIG. 190.—Potato Raiser.

In one type of digger a "share" catches the furrow at an adjustable angle, and the earth and potatoes both pass into a revolving drum, when the former is released through a wire sieve of which the

drum is made, the potatoes meanwhile being conducted backwards by the motion of the drum with a helical blade, and finally passed out at the end of the digger. Although the drum revolves in close contact with the ground it does not actually come in contact with it, and thus only ordinary draught is required to work the machine.

**Potato Sorters or Separators.**—Sorters were invented in 1885 and were the first machines of continuous feeding introduced for the purpose. A well-made machine is calculated to sort or grade about 5 tons of potatoes per hour in three sizes. They not only sort the potatoes but also deliver the “ware” into bags, the “seed” and “chats” into scuttles, and the soil underneath. The “seed” and “chats” are sometimes delivered on the front side, enabling the sorter to be used in confined situations, as, for example, at the clamp. Large machines, on the other hand, are constructed with the “seed” delivery spout at the back and the “chats” spout on the front side. If a platform is fitted it will afford every facility for the removal of “blights”, and should be placed conveniently for a man to work.

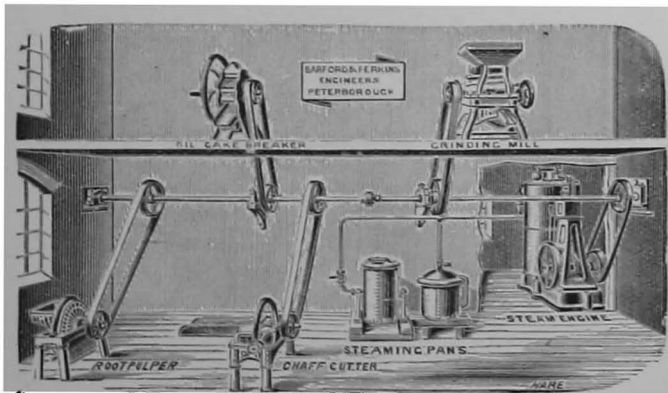

FIG. 191.—Section of Barn, showing arrangement of Food-preparing Machinery.

The sorter can be used either with or without the platform, but in either case the “ware” is delivered direct into bags. The top riddles vary in size from 2 to 2½ inches, and the bottom ones from 1 to 1½ inches. These sorters are at once adapted for grading all kinds of bulbs, onions, fruits, etc.

**Food-preparing Machines.**—The introduction of small portable gas- and oil-engines has enabled much of the hard and expensive manual labour formerly necessary in the preparation of the dietary of farm animals to be dispensed with, and even on farms of quite modest dimensions, grinding, crushing, cutting, or chaffing are practised to a greater extent than was possible with the older types of manual machines, and Fig. 191 affords some idea of the setting up of the necessary plant. The modern flour-mill has attained to a high degree of perfection, and while the student need not tax his mind with regard to its intricacies, he should, nevertheless, visit a mill and follow the

various processes in the manufacture of flour, taking careful note of the manner in which the various by-products are obtained. Very important principles are applied in this type of machinery, many of which have a very distinct and useful bearing on the more general barn machinery, and especially in the compounding of feeding-stuffs.

Grist Mills are invaluable to the farmer who feeds heavily with mixed meals, as in using them he knows exactly what any particular mixture contains. A good machine is also capable of grinding to fine flour, or to any larger intermediate size up to cracking or quartering beans.

Combined disk grinding mills and a pair of crushing rollers will grind almost anything, barley for barley meal, maize, or even oats for birds, while the rollers will crush oats or crack beans or peas.

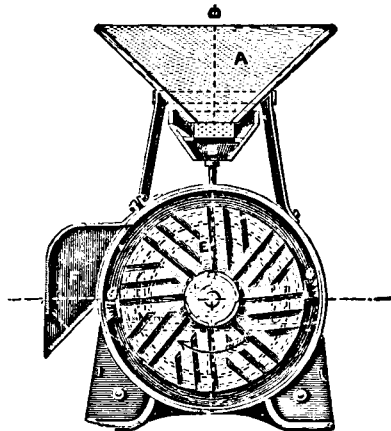

FIG. 192.—Longitudinal Section of Stone Grinding Mill.  
A, hopper; B, shoot; C, feed spout; D, fixed stone;  
E, running stone; F, delivery spout.

There are several excellent makes, both of stone (Figs. 192 and 193) and of disk grinding mills, on the market of various sizes. The latter type of grinding disks are made of chilled cast iron with fine ribs cast on both sides. There are two of them, one fixed and one revolving, and in most cases they are reversible and interchangeable. Thus when the ribs on one side are worn down they may be turned round, and therefore last considerably longer than single plates would. Some makes are flat and others slightly cone-shaped.

The grain is placed in a hopper at the top of the machine, and if there is a granary above, it is usual to cut a hole in the floor directly over the hopper, and to make a shoot by means of a sack with the bottom seam opened, so that a number of sacks may be shot on the floor of the granary over the hole, and the grain will automatically feed itself into the hopper with no risk of its being wasted or spilt.

The grain falls from the bottom of the hopper on to an adjustable shaker or screen, which regulates the feed to the mill, and also removes any foreign matter such as stones, nails, or pieces of stick, which would otherwise damage the grinding disks, through a perforated false bottom. The grain then passes, by means of a funnel between the disks, the distance apart of which may be regulated by a wheel and screw causing the rotating disk to move closer or farther from the fixed one. The closer the disks are set the finer the meal. Should necessity arise, very fine meal can be produced by running it a second time through with the disks adjusted to a closer degree. This, of course, requires more power, but is very effective, the meal thus treated being quite fine enough for young birds, pheasants, etc.

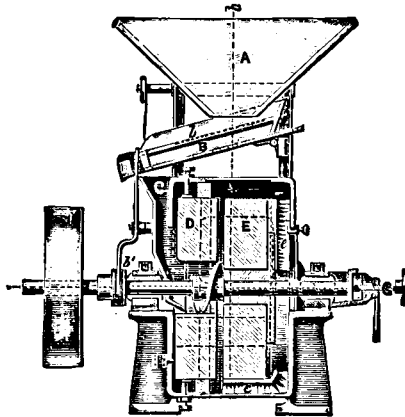

FIG. 193.—Transverse Section of Stone Grinding Mill.

The crushing rollers are very simple, the grain being fed from the hopper as described above, and the rollers being adjustable by means of screws, so that as the material falls between them it can be crushed to any desired degree.

Cake-breakers are almost indispensable on the farm, and usually comprise a pair of rollers made up of a number of star-shaped teeth, which, being mechanically coupled, revolve between one another so that the teeth interlace, and thus draw the slab of cake through and break it up. Some machines are provided with two sets of rollers, the second set being used if necessary simply by moving a shutter. The broken cake passes over a screen on its way to the floor, and it is usually advisable to instal the machine on the floor above the mixing-floor. The whole cake is then stored on this floor, and after being broken up may be run through a hole into a heap on the mixing-floor, as required.



A Combined Root Cleaner and Pulper is extremely useful on any farm, as the cleaning of mangels, for example, which have been pulled out of heavy tenacious soil entails much labour and waste when the work is performed by hand. By the time mangels are got out of the clamp in spring, the soil has shrunk from the root, and is soon dislodged by the rotary action of the machine. The cleaner comprises a drum or open cylinder some 6 feet or so in length, and 2½ feet in diameter. It is made of wrought iron, of T or other patent section, a portion of which is serrated, and which revolves at a much slower rate than the pulper barrel. Another pattern has a pair of spirally shaped shafts or screws set at a slight angle and revolving inwards. On both sides of these screws are

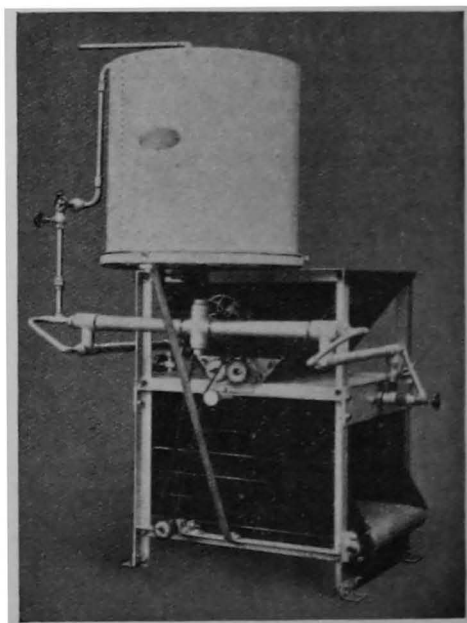

FIG. 194.—Reader's Steaming and Molasses Mixing Machine.

a number of triangular plates with crimped edges, against which the roots are knocked or bumped as they are carried along to the cutters by means of the two screws. The pulper barrel is composed of adjustable section plates, while the knives are also instantly removable and replaceable, and can be adjusted to cut the ordinary ¾ inch finger for sheep, double this width for bullocks, or even to slice the whole section of the root.

Chaff-cutters.—In the improved chaff-cutters a device has been introduced which no longer necessitates the attendant pressing the fodder forward with his hands, a practice which was often attended by disastrous results. The material now only requires lifting into

the box, and is then carried forward and compressed ready for cutting by the action of the web or carrier. Most modern machines, moreover, can now be regulated to cut three lengths by means of a sliding pinion.

A Combined Chaff-steamer and Molasses Mixer is extremely useful when it becomes essential to substitute large quantities of chaffed straw and molasses when roots are scarce. Previous to this invention the molasses were merely sprinkled over the chaffed straw or other material by means of a watering-can, but this does not ensure thorough incorporation nor even distribution. Thus, some animals would get too much treacle, with detrimental results, while others would get too little and consequently fail to do so well.

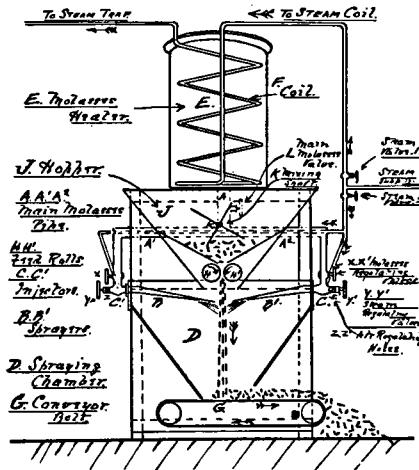

FIG. 195.—Section showing working of Molasses Mixing Machine.

In the case of a molasses mixer (Figs. 194, 195) the treacle is put into a drum, capable of holding the contents of a barrel, and warmed by means of a steam coil just sufficiently to enable it to flow into a main pipe, which bifurcates and leads to injectors, one at each end of the machine. During its progress along the pipe the treacle is strongly heated until it is mixed with steam and converted into treacle vapour, in which condition it is forced through sprayers or spreaders in a downward direction from each side of the machine, so that the chamber contains a mass of treacle vapour through which the chaff to be treated has to pass.

The chaff is fed from a hopper above, and may be led into this direct from a chaff-cutter placed on the floor above. It then passes through two rollers which deliver it across the whole width of the

392 BUILDINGS, MACHINERY, IMPLEMENTS, ACCOUNTS.

mixing chamber, when, after passing through the firing zone where both streams of vapour from the sprayers meet, it falls on to a moving belt and is delivered at the front. The molasses are not only thoroughly and evenly incorporated with the chaffed material by this process, but the steam also assists in softening the straw, making it palatable and more easily digestible, and sterilizes every particle as it passes through the machine. The machine is capable of dealing with a maximum quantity of sixty sacks of chaff per hour, and at this rate as much as from 20 to 25 per cent of treacle can be mixed. the regulation from zero to this figure being under perfect control.

## CHAPTER IV.

### LABOUR AND FARM BOOK-KEEPING.

**Manual Labour.**—The substitution of machinery for manual labour is less easy on the land than in the workshop, because agricultural work is not continuous nor indefinitely repeated, but, on the contrary, is restricted to certain seasons. A machine on a farm may only be required once a year, or at long intervals, as in the case of harvesters, hay-tedders, sheep-shearers, and many other machines, which also suffer from disuse, and are liable to be superseded by improved types. Secondly, a good deal of agricultural work requires to be done with judgment, as for example hoeing, cabbage-planting, rick-building, and stock-feeding; and no mechanical contrivance can rival hand labour in this respect. Thirdly, the work on a farm is limited as to quantity, and so distributed throughout the year that great rapidity becomes comparatively unimportant.

It is vital to a manufacturer that his machines should turn out "thousands a minute", and keep going day and night, but this is not the case on a farm, where a certain and very limited number of men are required, who are able to turn their hands to any kind of work. It is desirable that the few men and boys employed on a farm should have regular employment in a great variety of work, and this is unfavourable to the introduction of machinery.

Labour-saving implements are useful at times, but do not necessarily diminish the number of men and boys employed on a farm, neither do they always lower the wages bill for the year. There is also the superiority of hand over machine work which is universally acknowledged; and no machine can reap, mow, or hoe as well as a good man.

There are other considerations which militate against the use of machinery on farms. If work is taken away from men in the harvest field and done more quickly and cheaply by machinery, it may involve a higher level of winter wages, because harvest has customarily been looked upon as the opportunity for clearing off petty debts for clothes and boots, and the labourer can ill afford to lose his harvest money.

It is on these grounds that many really good farmers prefer to mow their clover and barley by hand, even if it costs a little more to do so. It is not from objects of pure benevolence, but rather to keep their men together, and contented, with a confessedly low rate of winter wages.

There are, however, many cases in which machinery may be introduced with excellent results, although the benefits are interwoven with drawbacks. Drilling is better than broadcasting, but it is both

slower and dearer than hand-sowing. Mowing and reaping by machinery, on the other hand, are more rapid than hand work, but their economy is sometimes doubtful when replacements, breakages, and horse labour are to be added. The self-contained labour of a good man may then appear to be no more expensive.

No agricultural operations can be compared with the work of the loom or the printing-press, for there is no startling increase in results on a farm—only a comparatively small advantage in speed and efficiency, an addition rather than a multiplication. Even in thrashing, which is one of the best examples of the application of complicated machinery to farming, it is curious that the cost is not so very much reduced in comparison with the flail—perhaps by one-half, but nothing comparable to the reduction of cost in weaving or printing.

The above remarks dispose of certain reflections upon farmers, as a body, to the effect that they are slow to adopt machinery. When, however, it is remembered that implements deteriorate in value immediately they are purchased, that they are quickly superseded by improvements, and that they, in many cases, sell for very little second-hand, the conclusion is inevitable that a man at from 3s. to 5s. a day is open to none of these objections, and that viewed as a machine he can adapt himself to any task, under a great variety of conditions. The same is true of horses, as already explained; and accounts for what strikes manufacturers as strange, namely, that farmers continue to rely upon men and horses as their chief sources of power.

*Manual Labour on the Farm.*—Farm labourers are divided into several classes which have little in common, and rarely interfere with each other. The teamsmen attend solely to their horses and tillage work; stockmen are entirely engaged with their sheep, cattle, cows, and pigs, or poultry. "Labourers," on the other hand, do anything they are required to do, and are paid on a lower scale; and "strappers" are called in during busy seasons and discharged when done with, and naturally receive higher wages than regular hands (see Piece Work).

There is much confusion in the public mind as to agricultural labourers and their wages. The fact is that many classes of farm men are well paid and comfortably off. On a large farm there is a foreman, a dairyman, a shepherd, a head-carter, an engineer, a thatcher, a hedger, sometimes a water-meadow man, etc.; and below them come helpers in the dairy, stables, stock-yards, and sheep-folds. The ordinary labourers are comparatively few in number, and most of the permanent-staff is composed of men in responsible positions. If a 500 acre farm be taken as a type it will be found that the heads of each department, with their helpers, constitute by far the larger numbers of names on the pay-sheet, and that three or four ordinary labourers make up the remainder—except, of course, in the busy seasons of the year. Wages are lower in the country than in towns, but expenses are many shillings a week less, and in many districts cottages are provided free of rent to head men. In rural districts cottage rents range from 1s. to 3s. a week, according to the rate of wages, but the terms of service often include a house and garden.

Many a man who has been tempted into the town at what seemed a high wage, has found to his cost that house rent alone reduced his spending power to the country level. As to what farm hands actually make, it is true that nominal wages range upwards from 12s. a week, but this low rate is soon raised when hoeing, haymaking, harvesting, and root-storing supervene, i.e. from March to November. It is in fact doubled, for a good man at piecework is not contented with much less, or if he is it is because he prefers to work short hours to get back to his own garden.

*The number of persons employed on farms varies enormously, according to the systems of cultivation followed. On ordinary mixed farms, where there is a fair proportion of grass land, from four to five persons per 100 acres, including boys, may represent the regular staff on the pay-sheet. That is from twenty to twenty-five names on a 500 acre farm. The number rises by about one-third during the summer, and sinks back to the winter level after the roots are stored. On farms where potatoes are cultivated on a large scale, or where fruit or hops are grown, it is impossible to state the number of people employed, or the cost of labour per acre, as it varies within wide limits. If a farmer on a mixed farm can keep his labour bill down to 23s. per acre over all, he is an economical manager, if his work be efficiently performed. Writers on costs have often assumed 30s. per acre as representing manual labour on arable land, but in fruit-growing districts such estimates are of no value.*

*Effect of Live Stock on Cost of Labour.*—It is generally thought that grass land must lower the cost of labour, but this is not necessarily true. No doubt it is the case where the land is grazed by young and dry stock, but not where milk cows are kept, as is now so general. As long as cows are milked by hand, and the milk yield is kept up both in winter and summer, they entail a great deal of labour, and it has been alleged by an excellent authority that the conversion of a large proportion of the arable land into pastures, with the object of producing milk, has increased rather than diminished the cost of his own labour per acre.

Live stock absorb much labour, especially on arable farms, as they are responsible for the cultivation of root and fodder crops, as well as handling the same during winter. Live stock are the cause of most of the work in the winter, such as carting out manure, shifting roots, hurdles, straw, and hay, chaff-cutting, grinding, cake-breaking, water-carting, and most of the tasks connected with the lambing pen, the yards, sheep-folds, and farm offices. A well-stocked farm must always involve a greater expenditure in labour than one on which few cattle and sheep are kept.

*Horse Labour.*—Reasons have already been given why horses have maintained their position on farms, and also why manual labour possesses merits over machinery which cannot be ignored. It must therefore be accepted as a truth that horses are likely to keep their place on farms for many years to come, and this view is strengthened by the high prices now given for young agricultural horses, at a time when motor-omnibuses, taxicabs, tram- and motor-cars are displacing horses in towns. Horses are as important in times of peace as in

times of war, in agriculture as in hunting, and there is no reason for fearing their abolition.

The number of horses required on farms is controlled (1) by the proportion of arable to pasture land, (2) by the rotation of crops, (3) by the stiffness or lightness of the land, (4) by the distance from railway and markets, and (5) by the head of live stock kept. Each of these considerations affects the amount of horse labour, and renders it impossible to supply a figure expressing the number required for a given area. Grass land involves a certain small expenditure of horse labour, which, however, is easily supplied by the teams required for the arable portion, so that the number of working horses may be calculated upon the area of arable land.

Next comes the rotation, which may be a four-, five-, or six-course, etc. It is evident that when land is allowed to remain two years under "seeds" instead of one, that two-fifths of the land is removed from the ploughed area, and if they are allowed to lie three years, three-sixths or one-half of the land is deducted from immediate tillage. In estimating the number of horses the rotation must be taken into account, and in order to arrive at a reliable figure the area under fallow or roots should be taken. Thus in a short four-course rotation there will be 25 acres of fallow to every 100 acres of arable land; in a five-course there will be 20 acres, and in a six-course about 17 acres. If a proportion of the arable land is always kept in sainfoin a still further reduction in the root area will take place, so that it becomes necessary to ascertain the amount of root land, and to use that as the unit for arriving at the number of horses necessary.

The tenacity of the soil is the next point for consideration, as the land may be light in character and adapted for two-horse teams, or it may be distinctly four-horse land. This is an important matter, but it would be incorrect to suppose that four-horse land requires twice as many horses as two-horse land. Heavy land is worked and cropped on a different principle to light land, and may require to be less frequently ploughed, and also needs less horse-hoeing, harrowing, rolling, and cultivating than land under a greater variety of crops. The number of horses required per 100 acres of stiff land need not therefore greatly exceed the number necessary on light land, and in both cases a pair to 50 acres of arable land fits many districts. The number of horses required on arable farms, on the basis of fallow or roots, may be stated in tabular form as follows:—

TABLE SHOWING THE NUMBER OF ACRES OF FALLOW AND ARABLE LAND WHICH MAY BE WORKED WITH ONE TEAM OF TWO HORSES.

Quality of Land.	Acres of Fallow.	Acres of Arable Land in different Systems.		
		On 4-course.	On 5-course.	On 6-course.
Very stiff land . . .	9	36	45	54
Stiff land . . . . .	12	48	60	72
Ordinary loams . . . .	15	60	75	90
Very light soils . . . .	20	80	100	120

A very large proportion of the arable land of this country may be worked by one pair of horses to 15 acres of roots, or 60 acres of arable land, but the above figures show how the number may vary with the tenacity of the soil and the course of husbandry pursued.

*Effect of Improved Implements on Cost of Horse Labour.*—Horse-drawn implements have hitherto competed very successfully with steam. The introduction of double and triple ploughs, spring-tooth cultivators, light drills, wide broad-casters and horse-rakes have almost revolutionized land cultivation. Heavy implements have been abandoned in favour of light steel frames and chilled working parts, capable of covering a larger area.

If these improvements do not diminish the number of horses per acre, they at least enable the farmer to cultivate his land more thoroughly, and to keep it in cleaner condition. It is not very long since the liquid manure drill was introduced as a novelty and as an improvement upon the old ash-drill; but both have found a successful rival in light two-horse drills, capable of distributing superphosphate without any admixture of water or ashes. The improvement is too evident to allow of any argument for the older methods. It reduces the number of horses for drilling roots by more than one-half, as may be easily shown.

In water drilling at least two water-carts with two horses each are necessary, for water must always be carted uphill. Four horses are wanted in the water-drill, and two in the harrows that follow it, i.e. ten horses. With the light "economical" drill two horses only are needed, water-carting is abolished, and a half-harrow drawn by one horse will cover the seed quite as well as a two-horse implement. Again, in ploughing, three horses in a two-furrow plough are sufficient for stubble land, and two may be used on loose land. The saving is most evident, and on light soils, where triple ploughs can be drawn by three horses, it is remarkable. So is it with wide drills and broad-casters, for width adds very little to the draught of a drill, and nothing to that of a broad-caster. Wide horse-rakes are also economical in the hay and harvest field. Older forms of wagons have given way to lighter boat wagons, which cost less money and are less cumbersome. There are many other ways in which horse-drawn implements have been improved of late years, with the effect of greatly diminishing costs, and even the number of horses required.

There are, however, so many odd jobs which need horse labour, and these are so often neglected for more serious operations, that it may be desirable to attend to these rather than attempt to work a farm with fewer horses. An odd or unattached horse is always useful, and where milk is to be conveyed to the station a pony is also necessary.

*Absorption of Horse Labour in Harvest.*—Economy in the use of tillage implements is all the more necessary now that harvest operations are so largely performed by horse-power. The absorption of horse labour in cutting grass and corn crops, horse-raking, hay-tedding, and stacking often becomes a decided drawback in root cultivation, and it is there that the use of labour-saving horse implements comes in with most effect. These novel tasks for horses



are inconsistent with lowering the strength of the team, but the adoption of lighter, wider, and more effective tillage implements liberates horses from the immediate cultivation of the land, and enables the farmer to carry on his entire work without getting "behind" in his operations.

*The Cost of Horse Labour* is difficult to estimate because it is so mixed up with manual labour. It is necessary to separate these two main divisions of labour, and the best course is to keep the pay-sheet distinct from the costs of horse work. If teamsmen and boys appear on the pay-sheet they ought not to be again charged against horses, or these costs will come twice over. On the other hand, they are incurred on account of the horses, and if, through the introduction of steam-power a horse is dispensed with, attendance upon him is also saved. If all possible charges on horse labour (including drivers) are debited against horses, it is clear that the expenditure on manual labour will be reduced; but there is a tendency to first state the cost of manual labour as arrived at from the weekly pay-sheet (including teamsmen's wages), and then to reckon the wages of the ploughman in estimating the cost of ploughing, thereby charging his wages twice. The effect is confusing, for it is true that laying down a horse in favour of steam saves both the maintenance of the horse and his attendant; but in estimating the actual cost of horse labour on the farm it is unfair to include drivers, first in the manual labour account, and then as an integral part of the cost of ploughing. Either course may be adopted, but we must be careful to consider which view is taken.

Manual labour, as previously explained, is considered to include teamsmen's wages, and it therefore only remains to consider the cost of maintaining horses apart from the pay-sheet. Manual labour on ordinary farms has been stated to vary from 23s. to 30s. per acre, and horse labour, in addition to these amounts, will be found to be about £1 per acre. This sum is arrived at by taking an average case of 60 acres of tillage land, managed on the four-course system, for every pair of horses. The bed-rock cost of keeping horses on a farm is much less than in the case of horses kept in towns or detached from land. Their food is produced at prime cost, and, in fact, they produce it to a great extent themselves. Their grazing ought not to include profits to the grazier, and, as already pointed out, they have often to be content with hay, straw, and corn which would not fetch the highest prices on the market.

Most calculations as to the cost of horse maintenance on farms are based on full allowances throughout the year at top prices, which is not according to fact. Another point is depreciation, but it is met by many farmers by breeding their own animals, and selling them at 6 years old when at maximum value. The annual cost of a pair of horses to a farmer includes food, litter, harness, shoeing, wear and tear of implements, depreciation, risks, interest, veterinary attendance, etc. In a paper contributed by the writer upon bed-rock costs of tillage (1906) a careful estimate was given both as to food and maintenance of farm horses, which is still applicable, although the present cost of oats on the market may be higher. Still, 16s. per

quarter for undressed oats of the weight and quality generally used on farms is not unfair, nor is £2 10s. per ton for hay, considering that the manurial residues both of food and litter are retained upon the farm.

ESTIMATE OF ACTUAL COST OF MAINTAINING A FARM HORSE, ATTENDANCE BEING CONSIDERED TO BE A PART OF THE COST OF MANUAL LABOUR.

	£	s.	d.	£	s.	d.
104 bushels of oats at 2s. . . . .	10	8	0			
15 cwt. of hay at 2s. 6d. . . . .	1	17	6			
22 weeks night grazing at 1s. 6d. } 3s. per week . . . . .	3	6	0			
22 weeks cut fodder at 1s. 6d. . . . .						
Chaff . . . . .	1	0	0			
Roots . . . . .	1	0	0			
	<hr/>					
Total food . . . . .	17	11	6			

Litter is sunk, as being returned to the land with the manurial residues of oats, hay, and other foods.

Shoeing and blacksmith's work, divided over all the horses . . . . .	2	0	0			
Harness . . . . .	1	10	0			
Stable utensils and repairs . . . . .	0	10	0			
Veterinary attendance . . . . .	0	10	0			
Depreciation on value of £45 at 6 years old . . . . .	2	10	0			
Risk 10 per cent, on an average value of £30 . . . . .	3	0	0			
	<hr/>					
Total cost . . . . .	£27	11	6			

Attention is drawn to the following points in the above estimate. (1) £45 is a high figure upon which to base annual depreciation; (2) 2 bushels of oats per week all the year round is a very full estimate for oats; (3) £5 10s. is a high rate for insurance and depreciation on a young and well-kept-up team. The estimate requires to be discounted rather than increased, and on this ground it seems more probable that the actual cost per horse would be nearer £25 per annum than the £30 which is often assumed to represent it. If we strain a point and allow £30 per annum as the cost (which is not, however, granted), there is this simplification of the calculation, namely, 60 acres of average tillage land worked by horse labour costing £60, or at a cost of £1 per acre. This, it is submitted, is a liberal allowance for the cost of horse labour per acre on medium land; and, taking the variations according to rotation followed and the character of the land, the cost will be found to lie between 10s. and £1 13s. 4d. per acre. This great difference is due to the land and the rotation—the highest price being incurred on stiff land, managed on a four-course shift, and the lowest on very light land managed upon a six-course system, in which half the tillage land is under temporary grass.

It may be said with some truth that as the cost of horse labour goes up, the cost of hand labour comes down. The maximum amount for the former will naturally be expended on heavy four-horse land, in which a team can only plough  $\frac{1}{4}$  acre per day, and the expense of a pair of horses is divided over only 36 acres of tillage. Here there

will be little hoeing or catch-cropping, whereas on light land there will be much hoeing and a greater variety in cropping. In order to arrive at the cost of team labour on a given farm, estimates should be made as to the number of horses required, and the cost of maintenance of each, but in doing so care must be taken not to confuse manual with horse labour; nor to make the mistake of charging harness, blacksmith, farriering, and repairs of implements twice—first as charges against the horses and then as trade-bills against the farm.

For Steam- and Motor-power, see Engines and Machinery.

**Piecework.**—The most economical method of paying labourers is by results, or piece. The system has never been in favour with trade-unionists, as it is thought by them to depress the wages of older and weaker men, but this really need not be the case if an equitable scale of payments is arranged.

The price of piecework ought to be based upon the amount which an able-bodied man can perform without distress, in order to earn a good wage. Thus, if a man can hoe half an acre of turnips in a day the price may be 6s. to 7s. per acre, and for twice hoeing 10s. or 11s. per acre, on the ground that the second hoeing is easier than the first. This last is a good system, as it induces the men to take pains with the first hoeing in order to give them less trouble when they go over the work a second time.

The principle of piecework can be applied to a large number of objects, but some work is better done by day-work. In any case a good deal of supervision is needed to avoid scamping, and remuneration should be made conditional upon the work being well performed, in fit weather, and under proper conditions. These restrictions sometimes cause friction, as when a band of men wish to tie up corn before it is dry, or to continue mowing before the wet has blown off barley.

One object in letting work by the piece is to get it quickly done, and, certainly, it is wonderful to notice how long men will stick over day-work. The price should not, however, be too high, as many labourers judge accurately when they have made what they call "wages", and leave their work early in the afternoons, whereas the idea is that they should work long hours and make double wages. Their object is to get a good price and find time to work their own gardens, and to this there can be no objection, provided the farm-work is not neglected. Another difficulty is found in the disposition of men to abandon their work on holidays, and this may extend over week-ends. In growing weather, root crops and weeds make such rapid progress in the interval as to render the price fixed upon inadequate; and a strike may be the result. These are serious drawbacks to letting certain classes of work by piece, but with care in selecting men and fixing a price which encourages industry, the system works well and is widely adopted.

**Piecework applied to Tillages.**—It has been recommended to apply piecework to tillage operations, but in spite of a few excellent examples the idea has not spread. One of the principal leakages in the conduct of a farm is the dilatoriness of teamsmen and boys. They waste time at every turn, without appearing aware of the fact.

They are slow in leaving the stable, long on the road, frequent in their stoppages while at work, and premature in "hatching off". The pace is also slow, and in travelling by rail it is noticeable that, as a rule, the teams passed in the adjoining fields are stationary. It is also notorious that an acre of land is rarely ploughed in the day, although at plough pace ( $1\frac{1}{2}$  miles an hour) and with a 9 in. furrow it ought only to occupy  $6\frac{3}{4}$  hours. It is the same with all tillage work, and is even worse in carting. In hauling manure to the field, the work often drags to a provoking degree, owing to the fillers waiting for empties, and boys idling when they meet on the road to exchange carts. Many other examples might be given, and the result is that the work done falls much behind the standards fixed in books of reference. A system of piecework has therefore been suggested by which the teamsmen should be paid at so much an acre for ploughing, harrowing, rolling, etc. If a teamsman's wage be 2s. 6d. per day, it would not be unreasonable to fix 3s. per acre as the price of ploughing, and harrowing might be paid at  $2\frac{1}{2}d.$  to  $3d.$ , and thus a scale of remuneration might be arrived at—as was, indeed, done many years ago by Mr. Matthews of Knittishall. There would be no difficulty in the case of known areas and straightforward work, but the principle would be less easy to apply when operations are constantly interrupted. Elaborate schemes of prices are to be found, but would be better constructed to suit the standards of different localities.

*Carting out Manure by Piecework.*—A method frequently used by the writer in carting out manure was found highly satisfactory to both fillers and spreaders. It consisted in a price of from 4s. to 4s. 6d. for filling and spreading sixteen to seventeen good single-horse loads per acre; the farmer finding carts and horses, and a man to draw out the manure into small heaps. This is equivalent to about 3d. per load, and the men divide their earnings among themselves and the boys; and the result is brisk work and no stoppages on the road.

*Piecework for Live Stock.*—The same principle may be extended to live stock by way of encouraging attention and care. Thus 1d. per single lamb weaned; 1s. for every pair of twins weaned; 1s. for every ram sold, on ram-breeding farms; 3d. for every pig weaned; 1d. or 2d. per score of eggs collected; 6d. per couple for all fowls marketed, etc. Dairymen may be paid at the rate of 1s. 6d. per cow in milk instead of in wages, the man finding milkers.

*Prices for Piecework.*—It is not proposed to give a full list of prices, as they vary considerably in different districts. The principle acted upon is, in the first place, the recognized rate of payment for the particular class of work. In cases where it is desired to introduce piecework instead of daily wages, the best plan is to ascertain the amount of work a good or average man may be expected to do in a day. Thus sowing grass seeds by the seed-barrow may be let at 2d. or 3d. per acre on the assumption that 20 acres can be covered in a day; singling turnips may be let at 5s. or 6s. per acre on the basis of half an acre per day; mowing grass, which is very hard work, and requires good food and plenty of it, may be let at 5s. or 6s. per acre, while mowing barley, or upland clover, may cost from 2s. 6d.

to 4s. per acre, according to the stoutness of the crops. An experienced farmer and his men may be trusted to settle such prices, and it will be found that the cost per acre will be diminished, even if the men make higher wages than when employed by the day.

Agricultural Labourers' Wages vary with the class of work, the pressure of work, and the skill and experience of the workers. If the lowest and the highest wages are compared they will be found to vary to such a degree that no figure can be used as an average. After many years experience in Wiltshire and Hants the writer believes that 12s. per week has fairly represented the winter cash wage of an ordinary agricultural labourer, in many cases the man paying his own house rent in the neighbouring village. So it was in 1877, and also in 1910, although there was a general reduction to 11s. during the severest times of agricultural depression.

This wage is given irrespective of skill or (within certain limits) of age, the smart man of 25 and the man of 60 being paid alike. Boys receive from 3s. to 4s. a week to start with, and are gradually raised until they claim man's pay, at which they stop until they become decrepit. The recent movement in favour of higher wages for agricultural labourers has no doubt affected all the above figures.

Twelve shillings a week does not, however, express the weekly or yearly earnings of a man, but his regular pay from the middle of November to, say, the middle of April. It implies regular employment in all weathers, and includes many wasted hours during which the men are storm-stayed, or are given work of comparatively unremunerative character to the employer. Extra men when wanted for thrashing and other kinds of work have usually received 2s. 6d. per day, and some good men find it better to remain unattached to a farm and earn what they can. Regular employment is, however, mostly regarded as desirable, and in many cases a cottage and garden on the farm are allowed free of rent, the man being subject to occasional calls upon his time on Sundays, or for attending upon sick animals, when occasion requires, without demanding extra pay as a right.

Some idea may be formed as to the estimation in which the men and their wives hold their wages by their willingness to take in an unmarried young labourer at 5s. or 6s. a week for board and lodging, and probably washing, which is really as much as the youth can spare out of his own 8s. or 9s. per week. There is no idea of hardship, and no appearance of under-feeding, discomfort, or untidiness, the lodger being regarded as one of the family, and as adding to the weekly income. The amount received on pay-day may much exceed the low level of 12s. per week, if the man has sons who earn money and receive payments for extras. These require to be carefully looked into, as they are liable to mount up to a disconcerting extent. The monotony as to a fixed payment per week is broken by many extras, even in the case of ordinary labourers, and include such items as thrashing days, working the engine, Sundays, egg-collecting, journeys, straw-drawing, and other forms of winter work. Almost every man on a large farm has opportunities for earning extra wages. On such a farm, for example, one labourer is selected as engine-man,

another as feeder of the thrashing-machine, the chaff-cutter, or the grist-mill. Another does all the thatching, sows the grass seeds, and builds the ricks; another is the water-meadow man or "drowner"; another acts as groom, etc. The result is that a pay-day never passes without some reckoning for these duties, so that 14s. or 15s. a week is nearer the amount paid than the fixed wage of 2s. per day.

As the season advances, the labourers (for we are not now considering the team- and stock-men) are given piecework in the forms of hoeing, docking, mowing, harvesting, root storing, potato gathering, etc.; and wages for day labour have in the past been raised to 3s. a day in haytime and 4s. a day in harvest. It is possible these figures may be increased in the future, but farming is not a business to stand heavy extra expenses.

*Unattached labourers* are employed in various ways during winter, either per day or by piecework, and often make high wages, although they are occasionally out of work. The great variety of work for which men are required in the country is probably not appreciated by those who bewail the hard fate of agricultural labourers. A good man is always in demand, and the following are some of the operations open to him:—

- |   |  |
|---|--|
| 1. Hurdle-making.                         | 11. Grubbing tree-roots and old fences.  |
| 2. Hedge-cutting, laying, and faggoting.  | 12. Quarrying gravel or chalk.           |
| 3. Helping with thrashing.                | 13. Cutting osiers.                      |
| 4. Shepherding fattening tegs.            | 14. Drainage work.                       |
| 5. Green-picking, for London markets.     | 15. Felling, topping, and lopping trees. |
| 6. Oak-bark stripping.                    | 16. Basket-making.                       |
| 7. Mowing rushes.                         | 17. Horse-breaking.                      |
| 8. Beating coverts for pheasant-shooters. | 18. Digging.                             |
| 9. Driving cattle to market.              | 19. Road-making.                         |
| 10. Cutting and trussing hay and straw.   | 20. Ditching.                            |
|   | 21. Thatching.                           |

In summer the same class of men engage in hoeing, mowing, haymaking, and harvesting; contract for lifting and storing root crops; form companies for sheep-shearing—a work which occupies many weeks during summer, but is disappearing on account of shearing by machines—and they generally aim at making their 5s. a day at least.

The unattached labourer makes more money than the permanent hand, but neither of them is an object for commiseration. It is, in fact, a nice question whether the loose or the attached man does better in the end, but 12s. a week as a standing wage, with the usual accessories, has seemed, on the whole, to be thought fairly equivalent to what the unattached labourer can hope to make, considering that he may not always be able to find work.

*Variations in Standard Wages.*—Twelve shillings per week certainly represents a low scale of payment. It may have been fairly correct for agricultural counties in the past, but is a good deal below the

payments given in the North of England, the Midlands, and the manufacturing and mining centres. The lowest wages are said to be earned in Oxfordshire, 14s. 6d. per week, and the highest in Durham, 22s. 2d. per week.

*Stock- and Horse-men.*—These men are on a different footing to the ordinary farm labourer. They are paid at a higher rate, and have better chances of preferment. There are situations in all branches of live-stock management which raise a good man into a superior position in comparison with ordinary labourers. He is skilled, to the degree of being an expert, and possesses the confidence of his employer. Even in ordinary cases, head teamsmen, dairymen, and shepherds are paid 2s. per week above the current wage of the district, and are also provided with a house and garden, and receive extra remuneration for certain services or at stated periods. Teamsmen and boys, being debarred from piecework in the field, are given from 20s. to £5 each at Michaelmas, under the name of over-money, and those who have cottages are allowed manure for their gardens, and have their coal and firewood carted free. Dairymen are allowed a stated quantity of milk, and a pound of butter a week. They are paid for egg-collecting and chicken-rearing, and may have 3d. a head for all pigs weaned; and small as these payments may appear to be they recur in some form at every pay-day and increase the week's takings. Shepherds enjoy similar privileges to teamsmen, but also receive extra remuneration at lambing time (often £1), 1d. per single lamb weaned, 1s. per pair of twins weaned, £3 at Michaelmas, and extra pay for shearing. They also have 10s. a year for dog keep, and on ram-breeding farms 1s. for every ram sold. Shepherds of large flocks do fairly well, and enjoy a highly respectable position, as in fact do all these men.

The possibilities for a good stockman are excellent, as he may rise to a head place on a stud-farm, in a pure-bred herd, or a high-class flock, and become well known to a large circle of admirers. The success of a herd or flock depends very much upon the herdsman or shepherd, and hence skilful men may secure very excellent places.

*Cost of Labour per annum.*—If we take a farm of 600 acres in extent, of which 200 are in permanent pasture devoted to dairy (and especially if it includes 20 or 30 acres of water-meadow), the entire area may be viewed as one in respect to labour, and the expenditure upon wages and extra wages may be taken at £800 a year, or 26s. 8d. per acre. Good management may reduce this amount to 23s. 6d., or with less care, or greater liberality, it may run to 30s., but this is as near the ordinary expense of labour as can be stated. It is a question whether "all tillage" would greatly affect this figure, and the controlling element would be the amount of live stock maintained. Thus light land adapted for turnip husbandry and catch-cropping absorbs more manual labour than clay land occasionally summer fallowed.

The largest amount spent in labour occurs on potato and fruit land, and on hop farms, and wherever the cultivation approaches market-gardening. Here the cost of labour may be £3 or £4 per acre over all, or, as garden cultivation encroaches upon field-work, it may

reach a figure which cannot be expressed in per acre terms. The capabilities of land under certain circumstances to absorb labour are practically limitless, as a man might conceivably devote all his time to half an acre of land, or even less. It is considerations such as these which bear out the idea of a population entirely devoted to the cultivation of the land, and a country, even such as England, self-supporting as regards its food supply.

They are, however, inconsistent with the present time, or even with the future ; for by far the greater area of this country consists of land better adapted for extensive than intensive cultivation ; and a sparse population, with great distances from markets, constitutes a bar to small or petty cultivation which no legislation can surmount.

**Hedging and Ditching.**—The management of hedges, and the cleaning out of ditches and watercourses, is a very important branch of farm husbandry. Agricultural Societies all over the country have recognized this fact, and many of them have instituted competitions in hedging and hedge-laying in connexion with their annual shows ; these competitions afford the student an excellent opportunity for seeing how the work is done by experienced men, and they should not be slow to take advantage of it.

Some hedges are naturally much more difficult to deal with than others, but as a rule good work can be done where, say, eight years growth of young wood has been produced. It is not easy to deal with a hedge that is composed of mixed shrubs, or one that is in a very bad state of decay.

The work is easier to follow when one knows something of the actual object of the fence. For example, it may form either a barrier against the intrusion of live stock, a form of shelter for cattle and growing crops, or merely serve to determine a boundary-line. In the first two cases the hedge must be composed of suitable plants, growing in such a fashion as to form an impenetrable bar to cattle, horses, sheep, or any other live stock ; or it must be high and close enough to break the force of strong winds. The whitethorn, as a rule, makes the best hedge for this purpose, but transplanted seedlings, and not self-seeded plants, should always be used, whether for planting or for filling up gaps in old hedges. Another good, quick-growing hedge plant is the Myrobella plum ; and close compact hedges of beech, hornbeam, blackthorn, and oval-leaved privet may also be noticed.

The common whitethorn does best, as a rule, on heavy, retentive, loamy soils, overlying a clay subsoil. If it is planted over strata of adhesive impenetrable gravel the plants will invariably canker. A newly planted hedge is generally protected by a rail or wire fence at first ; otherwise cattle will be continually browsing on the young plants, and this will invariably cause the branches to canker, become stunted, and finally to die. In the second year strong autumn-planted quicks should be cut to the ground line, or at least to within 6 inches of it. A close healthy bottom-growth will then be produced, with strong shoots breaking from below the surface of the ground ; or if 6 inches of stem are left, the plant will form a "leg" as it were. The latter practice is generally adopted in the case of garden hedges,



where the ground underneath the hedge is regularly scoured and kept free from weeds.

Hedges are frequently planted on banks, say 5 or 6 feet in width ; but this method cannot be recommended for arable land, as it encourages weeds and takes up much room. A good hedge can be obtained by planting two parallel rows of thorns, say about 8 inches apart and 9 to 12 inches wide between the rows. If a ditch is required on one side the earth thrown out of the cutting should be laid on the bank. And if a live hedge is planted on a highly raised bank, the latter must always be battled to an angle at which it can stand safely ; different soils have different "natural angles of rest". The ditch indicates that the hedge belongs to the property on which it is made.

The tools required for cutting and laying a hedge include a bill-hook, a good strong axe, a wooden mallet, and a pair of stout leather mittens. Thorn hedges should, whenever possible, be cut with an upward stroke (Fig. 196), otherwise moisture and vegetable growth will accumulate in the cavity formed by the shattered stool,

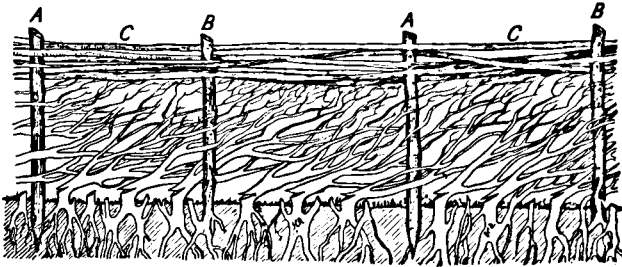

FIG. 196.—Diagram showing method of laying a Thorn Hedge. *A*, dead stakes ; *B*, live stakes ; *C*, heathers.

and give rise to canker. Hedge-laying is extensively practised in Lincolnshire, and well understood in Warwickshire. In some of the southern counties it is customary to allow hedges to grow to a considerable height without being periodically trimmed ; laying is very beneficial in such cases, because it encourages strong young shoots to spring from the base wood.

In the first place, any wood not required for laying should be cut out, and live or dead stakes placed in position to support the newly laid hedge. If live stakes are used they must be notched fairly deeply at the bottom (Fig. 196), otherwise they will produce a thick unmanageable growth at the top. If new growths are to be treated and trimmed as an ordinary hedge, it is advisable to use dead stakes. The tops of the stakes should be headed off level, but not to a point, by a clean cross cut, and bound firmly and securely together by twisting binders or "heathers" (headers) in and out between them. The laid branches are pressed down into their places, however, before the heathers are used, and in doing

this the small wood, or "brush", should in all cases be pushed through on to the field side, where it will form some protection to the young shoots that subsequently break from the bottom of the hedge, and which would otherwise be eaten by live stock grazing in the field (Fig. 197). An alternative is to pack trimmings into position at the bottom of the hedge on the field side, removing them two years or so afterwards, or as soon as the young shoots have become well established.

One other important point to remember is that a hedge should always be laid with an upward inclination, so that the flow of sap may be encouraged instead of being checked. The best time to do this work is winter, when the wood works well, and, where possible, a hedge-layer should always work from the ditch side. The most suitable shape for a farm hedge is conical, with a flat top, not more than 9 or 12 inches wide (Fig. 198, *A*). Low, big-topped hedges are

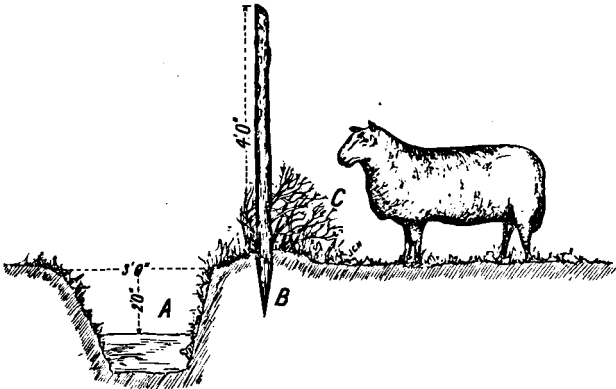

FIG. 197.—Section of Laid Hedge. *A*, ditch; *B*, dead stake; *C*, brushwood to protect young growth.

unsuitable, because cattle will graze on the young tender growths and spoil them, and they also eat out the tops of low wedge-shaped hedges that run up to a fine point, and leave the top of the hedge ragged and uneven (Fig. 198, *B*).

Ditches are constantly in need of attention on the farm. Often banks will give way owing to the land having been ploughed too closely to the ditch, water having accumulated in the furrow and soaked downwards; while another cause of a ditch giving way is the practice of throwing the cleanings on to the edge of the bank, instead of in the middle, over the roots of the hedge plants. After the roots of grasses have bound the soil together, there will, as a rule, be no further trouble on this head. The bottom of a ditch should be kept clean at all times, for if this is neglected it will quickly become choked with rushes and aquatic weeds, which will establish themselves very firmly and entail a considerable expense in cleaning them out.

Similarly, it is essential to keep any culverts that lead into the ditch freely exposed, otherwise sediment will quickly block them up.

**Thatching.**—Well-grown, stiff wheat straw makes the best thatch for all general farm purposes. Rye straw, or reeds, when obtainable in sufficient quantity, are, however, more durable where a thatch is required to last for a number of years. Heather may also be

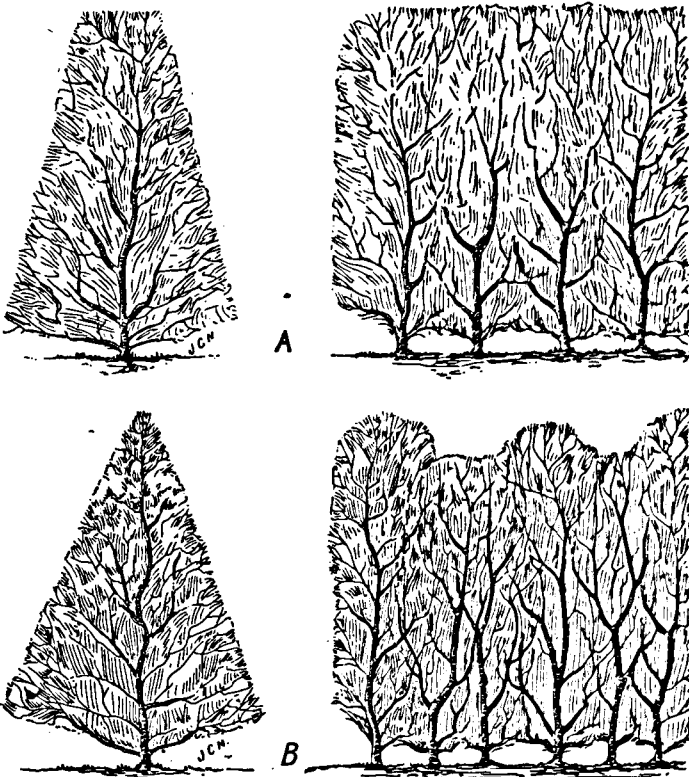

FIG. 198.—Methods of Cutting or Trimming a Hedge. *A.* Correct method—wedge-shaped hedge left broad at top. *B.* Incorrect method—wedge-shaped hedge growing to sharp point at top; cattle browse off the top and leave the hedge ragged and uneven.

employed in some cases, usually for ornamental or decorative purposes. If corn is not intended to remain in the rick for any length of time, oat or barley straw may be used instead of wheat straw, but generally the latter is best for all purposes, and is usually more economical.

The thatcher's outfit consists of a bill-hook, a pair of ordinary sheep-shears, a fork, a straw-rake or comb, a ladder long enough to

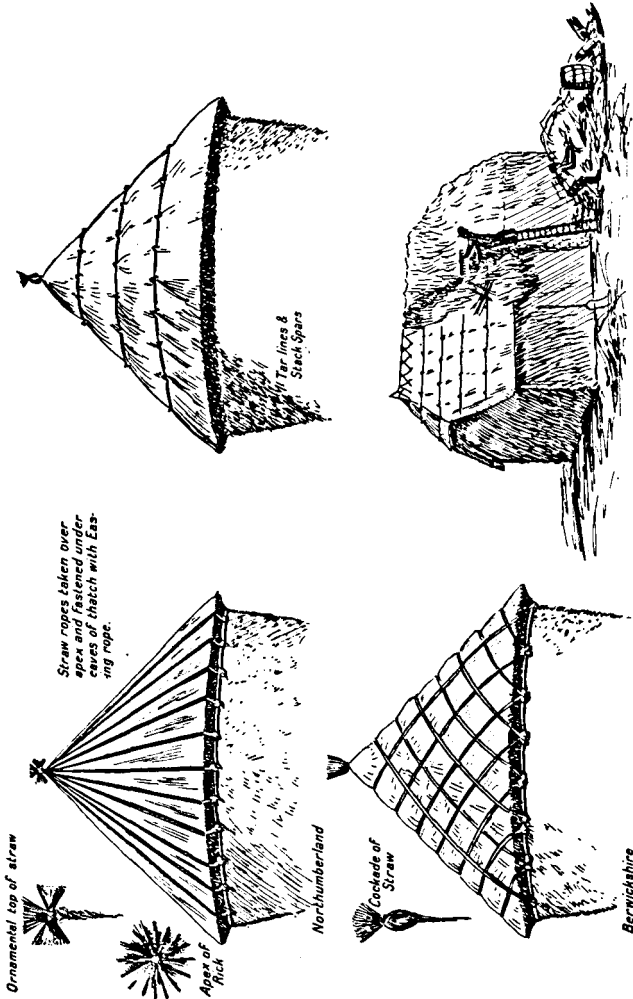

FIG. 109.—Thatching, showing different systems, and method of "yealming" and laying the straw.

reach the top of the ridge when it is laid flat on the roof, a quantity of tarred twine or binding cord, some split hazel rods or spars, and a wooden mallet with which to drive them in.

*Preparing the Straw.*—The first thing to do in thatching a rick is to prepare a suitable quantity of straw. This is known as "yealming", and the bundles that are made up by the assistant and passed up to the thatcher on the rick are termed "yealms". Yealming (Fig. 199) consists in drawing out large handfuls of straw from the bottom of a heap. The straw must first be moistened, as it will not "pack" tightly and securely if it is drawn dry and loose. For this reason straw intended for thatch is often spread, or opened out, when rain is falling in order to get it damp. After damping, the heap is usually trodden down or beaten with a fork so as to rid it of loose ends or rough material, commonly known as "flag and shack", which might otherwise check the flow of water over the thatch. The yealms are made by seizing as much straw as possible in both hands held close together, pulling it out with a sharp swing to the right and another to the left. There is a certain amount of "knack" in this, and if the student watches an expert thatcher very closely he may be able to pick up the art quickly. After drawing, the straw is laid on the ground at the operator's feet, and when enough is collected to fill the grip of both hands, the loose pieces are worked out by combing with the fingers, and are then placed crosswise on a short rope or cord. These are yealms, and are secured by a running noose and so passed up by the server to the thatcher. Yealming is often done months in advance of thatching, and the yealms are stacked ready for use.

*Making a Roof.*—It is quite useless to lay a good thatch on an uneven roof. After a rick has been standing some little time, hollows and humps are seen to appear in the roof, and the top needs levelling before commencing to lay the thatch. All the humps should be carefully combed down and the hollows filled in with loose straw, a tightly-bound "dummy" or bale of straw being placed on the ridge so as to bolster it up.

*Laying the Thatch.*—In laying the thatch (Fig. 199) the first yealm is laid at the bottom on the eaves line, and others are placed above and partly overlaying it, until the ridge line is reached. Usually a double layer of straw is placed on the eaves line so as to cause the water to shoot off without injuring the sides of the rick. In the actual performance of the work the thin ends of the yealms are always worked carefully into the roof of the rick, and each overlaps the lower one. The straw is kept damp, and combed with the rake so as to keep it even. Afterwards it is beaten flat with a sort of wooden shovel, and pegged and corded so as to keep it in position. To ensure a good finish, hipped-end ricks are generally commenced at about the middle of the side, and gable-ended ricks at one end. The width of roof that a thatcher can cover in one working is known as a "stetch". It is not advisable to try and work too wide a stetch at once, for the thatch cannot be laid so effectively at arm's length as it can when worked at a comfortable distance. This entails constant shifting of the ladders.

*Pegging and Cording.*—Split hazel, willow, or oak pegs with pointed ends and smooth sides and about 2 or 3 feet long (known as spars) are driven into the thatch as the work proceeds; but it is essential to drive them in rather horizontally and not vertically, otherwise they

will easily convey water into the interior of the stack. Binding cord is then looped round the spars, or stobs, so as to keep the thatch in position. Very little pegging and cording is required, however, where a mediumly thick thatch has been laid well and properly. After pegging the thatch in this way the eaves are pared off, and a smart finish given to the rick by trimming off all loose straws with shears. The eaves must be so formed as to clear the drip, or water will almost certainly find its way into the rick. The sides of ricks should not bulge out, or the sheaves will be seen to take in "pen wet". In bean and pea ricks the sides, as well as the roof, should be thatched.

## FARM BOOK-KEEPING.

Simplicity and accuracy are the two most important points in farm book-keeping, and both may be achieved without any very complicated system of accounts. On the other hand, farming is a business which suggests analytical book-keeping, or a division of costs among the various departments, such as crops, and different classes of live stock. The aim of analysing costs is to find if a particular cultivation, or description of stock, pays; but the difficulties are great and fail in accuracy. For example, it would be impossible to arrive at a sound conclusion as to whether bullock fattening has paid *per se*, without making a large number of estimates as to the cost of natural foods and litter, the value of manurial residues, the precise cost of grass and hay, etc. If costs are assumed at too high figures the cattle will be brought in debtors; and if the manure is valued too highly, they may be made to show a too large, but fictitious, profit. The result depends entirely upon the values attached to a large number of items, and the figures used are, after all, dependent upon rough estimates and cannot be verified.

It is equally impossible to arrive at the precise cost of horse labour, although such figures as 2s. 6d. or 3s. per working day have commended themselves to some authorities. They are not, however, accurate, and in order to arrive at the cost of raising roots or green fodder, even 1d. per day on horses becomes important. Horse labour is certainly a cost as much as is manual labour, but by crediting the horse account with too high an amount *per diem* it is quite possible to show a profit on the horses, which, in fact, converts the farmer into a haulier who lets out his teams to his farm at a profit, but at the same time causes other accounts to show a loss. The difficulties of analytical book-keeping as applied to a farm are indeed insurmountable, because the cleaning of land and manurial applications ought to be divided over a series of crops, and this would necessitate assumptions which may be false and cannot be absolutely reliable.

The work entailed upon the farmer in analysing his costs would be very great, and when effected would be found to depend entirely upon judgment; and it therefore scarcely appears desirable to make the attempt, except upon experimental or educational farms, in which working out such statistics might be instructive and of inestimable

value to students. It is also more than doubtful if any actuary would pass entries of a fictitious character.

The business farmer will find it better to confine himself to cash transactions, and to make his payments as much as possible by cheques. It will also facilitate his book-keeping if he passes all his large receipts through the bank, so that the bank pass-book shall show most of his transactions. As this system cannot always be carried out, he will also require a Petty Cash-book, which, for convenience, may be kept locked in the cashbox. Cheques for wages and other current expenses should be drawn against Petty Cash, and entered on the debtor side of this book, as may also small sums receivable on the credit side; and the Petty Cash should be balanced once a month and the balances transferred to the Farm Cash-book.

The Cash-book may also be a Day-book or Journal in which are entered all transactions other than the petty receipts and payments. It should be wide, so as to allow of separate rulings for all the principal kinds of produce, as well as for those which cannot be classified, and may therefore be entered in a column for Charges or Sundries. By making use of separate columns for the principal items, both of expenditure and receipts, a Ledger may be avoided; or, if a Day-book of simple ruling is used, each transaction may first be entered in a "Journal", and then transferred to its proper heading in a Ledger. Single entry is to be recommended on account of its simplicity, but if double entry is preferred each transaction will appear on both sides of the Ledger. If, for example, sheep are sold for cash (and most transactions on a farm are of this nature), the result will appear in the Cash Account as "Cash Dr. to Sheep", and in the Sheep Account as "Sheep Cr. by Cash". If petty items, such as cash for sheep-skins or mutton, occur in the Petty Cash-book, they are ledgered in due course as follows: "Cash Dr. to Sheep (Skins)," and again as "Sheep Cr. by Sheep (Skins)". By this system the sheep are credited for all receipts on their account.

Similarly, if sheep are bought for cash, the transaction will appear as "Sheep Dr. to Cash", and again as "Cash Cr. by Sheep". Double entry is necessary where there are a large number of credit transactions as between firms or dealers. As these transactions are rare in farming and easily remembered, it will be found best to use single entry, and keep a memorandum as to what may be owing to or from a particular firm.

If all transactions are entered under their respective heads, it will be quite easy to see at the end of the year what has been received and what has been paid upon each account, and with this object the Petty Cash transactions ought to be transferred to the Day-book in order that all petty receipts and expenditures may be debited or credited in their proper places; the result will be a complete account of what has been received or paid for sheep, cattle, pigs, corn, poultry, etc., during the year.

*Valuation of Stock.*—Such an account as the above should be a true account of all sales and purchases made during the year; but in order to arrive at a conclusion as to the result of the year's trading, it is necessary to begin and end every year with a valuation of stock.

The best time to make a valuation is Michaelmas, although there is no objection to closing the books and opening them for the next year on December 31, or at Lady Day.

A valuation should be made of all live stock, corn, feeding-stuffs, implements, tillages, manures, and everything which belongs to the tenant, and each account should be opened with its own valuation. Thus, if there are £1,000 worth of sheep on the farm the sheep account would open with an entry "Dr. to Valuation, £1,000", and at the end of the financial year the same account will be closed with an entry "Cr. by Valuation, —". The same sum which closes the sheep account for one year as a credit opens the next year's account as a debit item, or, in other words, the sheep account is made debtor for the sheep on the farm at the beginning of the year and credited with the sheep stock at the close of the year. These valuations, together with all the sheep transactions effected during the year, show what the sheep have done for their owner in the interim. The same system is used for every account, and the result is a gross statement as to what any kind of stock or crops has done during the twelve months. It is a simple cash statement, and does not pretend to be more.

On most farms, where a regular system of farming is followed, the valuation will be found to vary within narrow limits, and it is better to value below the realizable or marketable value. Implements and tillages need not be minutely valued, but may be assumed as kept up from year to year. If, however, a detailed valuation of implements is made at the outset, a deduction of 10 per cent per annum may be made each year, and new implements bought during the year may be added at cost price. A fresh valuation of implements may be made, say, every five or six years. Horses, cattle, sheep, pigs, and poultry should be valued in detail, and the entire business of valuation may be carried out without much difficulty. This is a simple system of accounts, well within the powers of any farmer, but it is sufficiently complicated. It will also be found that several other books are necessary in the conduct of a farm, the mere enumeration of which shows that farm book-keeping, even upon the simplest principle, requires a good deal of clerical work. The following books can scarcely be dispensed with if the farmer's interests are to be safeguarded.

*Labour- or Wages-book.*—This book is ruled for each day of the week, and may be so constructed as to enable the farmer to analyse his labour by charging each man's wages to the particular department, field, crop, or stock, on which it has been expended. Thus the shepherd and his helpers may be charged against sheep, or the dairyman against cattle. Such analysis is, however, difficult to carry out absolutely, and is liable to inaccuracies where men are called away from their principal jobs to assist in other departments, as in harvest for example. Analyses of labour may prove a satisfaction to the farmer; but in the system of accounts now recommended the results should not appear in the Cash-book, Journal, or Ledger. The Wages-book contains a record of all names, contracts, rates of payment, drawings on piecework, perquisites, and "over-money", and



the total sum paid is shown at the foot of the money column and carried to the Petty Cash-book, where it assists to balance the cheque for "Wages" or "Petty Cash" on the debtor side.

*Dairy-books.*—The dairyman is provided with a set of books, which he keeps and presents on pay-days. He accounts for all cash received for butter, milk, poultry, or eggs sold at the dairy, and hands over the cash at regular intervals. These amounts are paid into the petty cash-box and duly recorded. The dairyman will also keep a "Service-book" for cows and sows, showing dates for calving and farrowing. He is also provided with ruled sheets for his Milk Record. A large blackboard, ruled for morning and evening of each day, and with all the names of cows in milk on the left-hand column, is found very convenient. The board is securely fixed against the wall of the milking shed in a good light, and the records of weight of milk in pounds is entered against each cow's name in white chalk. The figures are copied on to a sheet of paper, and the board is then washed for the next registration.

*Cropping-book.*—It is desirable to preserve a record of the cropping of each field, showing when it was last in sainfoin, clover, wheat, swedes, or any other crop.

*Granary- and Stores-book.*—This book contains a record of corn brought into the granary or discharged, of purchased food, sacks, stores, etc., with dates, and is best kept on a rough desk in the stores. Such a book is, however, seldom seen.

*Herd- and Flock-books.*—Every farmer who keeps pure-bred or pedigree stock of necessity keeps a private herd- or flock-book, for without it he would be completely lost. Private herd-books, with proper rulings, are supplied by many of the Breed Societies, and should be punctually kept up. Without such books no breeder would be able to certify the breeding of his animals, or to enter them in the records of the society.

*Farm Diary.*—Many farmers keep a diary of all the principal events upon their farms. It contains records of the weather and the seasons, of prices, yields of crops, experiments, calculations as to costs and returns, visitations of disease, etc. It may also contain notes as to contracts and tillages, dates of sowing, mowing, and cutting, all of which become highly interesting as references as time runs on.

*The Farmer as a Book-keeper.*—From the above account of the books which a farmer is almost compelled to keep, it will be seen that he cannot be reasonably accused of "keeping no books". Some form of Journal, Day-book, or Ledger—some sort of balance-sheet—he can scarcely avoid; but at the same time a system of passing all sums through the bank as separate credits greatly simplifies his book-keeping. A Bank Pass-book and Petty Cash-book form excellent bases, and the latter will furnish particulars as to unbanked items, bank charges, interest, etc. The farmer's books should agree with the Banking Account, but some form of ledger or division of receipts and expenditure, under their respective headings, will show the gross amounts received and disbursed for each department of the farm. When to these cash statements are added a Milk Record, Wages-book, Dairy-books, Cropping-book, Private Herd- and Flock-books, and

a well-posted-up Farm Diary, no one can say that the farmer keeps no books.

With such a large amount of necessary clerical work, it seems a pity to suggest for adoption an elaborate system of dividing costs of production, an analysis of horse and manual labour, and a meretricious and speculative apportionment of charges with an attempt to divide costs between successive crops. It is evident, upon the face of it, that such apportionment can only be effected by estimates or guesses, and the further it is pushed in the direction of accuracy the more actual weighing of foods, litter, and roots will be necessitated in order to get at the actual cost. Equally necessary will it be to put a value per ton upon all roots, fodder, etc., produced at home, and supplied to cattle, sheep, pigs, or horses. The whole subject bristles with difficulties, and the worst of it is that, after all, the values and prices affixed are not cash values, but mere exercises of judgment. Well-thought-out calculations as to actual costs and profits would be suitable material for the pages of a farm diary, and a good farmer would be able to construct a costs-sheet against his sheep or cattle of more practical value than could possibly be arrived at by an elaborate analysis of horse and manual labour, fictitious estimates of quantities and values of grass, roots, or litter supplied, all reduced to figures not reflected in any actual cash transactions, but merely the result of judgment or estimate.

As to valuing green crops, roots, etc., it would be extremely difficult to fix amounts, as the value of these natural foods varies enormously. Sometimes they are superabundant and would command no price, and yet in a few weeks they might be at a high premium. It is also as well to point out that if an analysis of accounts of this nature is once commenced, it must involve repeated and re-echoing entries. For example, if cattle are debited for grass, roots, etc., they must be credited with the manure they leave. When this manure is applied to a crop, the crop must be brought in debtor for it at the same rate and credited with unexhausted residue, which would lead to endless complications. Besides, if the manure is charged against root or fodder crops that are not intended to leave the farm, the charge is largely imaginary, for they pay for something which they do not carry away with them. What would be necessary would be fractional charges extending over a long series of crops.

# PART IV.

## *DAIRYING.*

## PART IV.

### DAIRYING.

---

#### CHAPTER I.

##### MILK AND BUTTER.

**Buildings for a Mixed Farm.**—The plan on p. 420 is adapted for a mixed farm where a large area consists of permanent pasture. The stabling for heavy horses is consequently limited, while special accommodation is provided for rearing store cattle and for fattening stock during winter. In the cow-house there is standing room for twenty milking cows, with two feeding passages and one central dunging passage. The covered yards can be used for weaners. At certain seasons of the year, particularly during hot days in early summer, it is preferable to keep the calves under cover during the day, when flies are troublesome, allowing them out on the pastures at night.

No pigsties are seen in this block, as it is considered more hygienic to house the pigs away from the main block of buildings, where the latter cover a small area. Nevertheless, the pigsties should be within reasonable distance of the food-store and dairy.

Dairy farming has made rapid strides during recent years, and much of the heavy land formerly restricted to the growing of wheat, hops, and beans has now been laid down to permanent pasture. This change is very clearly demonstrated in counties like Hampshire and others with a rapidly increasing population and where much heavy or woodland ground exists. Residential counties and populous cities and towns consume enormous quantities of milk during the year, to say nothing of manufactured substitutes and milk preparations imported from abroad.

**Selecting a Dairy Farm.**—It is easy to fix in one's mind all the good qualities a dairy farm should, or might, possess, but it is quite another matter to find them. Good farms rarely come into the open market, and one has often to be content with very indifferent places in which to carry on the business of dairying. Improvements of land and premises can, however, soon be effected, especially when the tenant is encouraged and assisted by a sympathetic landlord.

It has been the writer's pleasurable duty to judge dairy farms in competition for prizes awarded by agricultural societies, and in doing

so he has come across some excellent examples of the adaptability of old buildings to modern ideas, and where no better hygienic conditions could exist, even if buildings were erected with all the latest improvements.

The rent of a farm, whether arable or pasture, will depend largely upon whether it is in close proximity to a good market, and also upon the quality of the soil. A beginner, or inexperienced prospective farmer, could have no greater problem to solve than that of selecting a good farm, as so many factors must be taken into consideration.

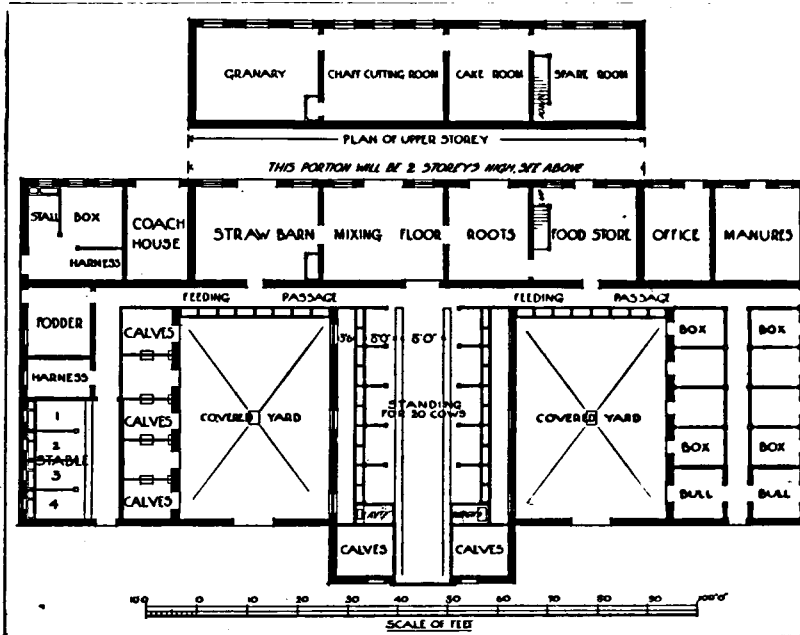

FIG. 200.

A reasonable landlord, or agent, is a first essential, and if the landlord, his agent, or both, are well versed in agricultural matters, the tenant will then stand more chance of ventilating any grievance that may arise; for example, bad roads, buildings, fences, all mean time and considerable expense to keep in repair, and much of this work can be legitimately divided between landlord and tenant.

*Altitude, Aspect, and Climate.*—The best grazing districts are found along river valleys, as the student may have observed in any part of the country in which he has lived or travelled. Where a river

flows sluggishly through an expanse of flat country it often becomes necessary to open up watercourses, somewhat after the manner of those employed in water-meadows (Fig. 9), in order to prevent the surrounding ground from becoming saturated and stagnant.

The higher the altitude within reason, the healthier will the surroundings prove for stock of all ages. In many parts of the country we meet with low-lying land, large areas of which have been converted into water-meadows. When properly irrigated, and the ditches kept periodically scoured, these meadows are invaluable for carrying dairy stock in seasons of drought, while there is always a good water-supply available, but in late autumn and winter much sickness prevails, especially when the meadows are neglected. Heavy dense fogs envelop the ground at night, and often well into the day, and husk will make its appearance among older cattle, especially Jerseys.

The herbage comprising many such meadows is largely composed of sedges, rushes, cotton grass, carex, ranunculus, and very many other species and varieties of indigestible and innutritious plants, and no wonder we hear farmers sometimes say that this or that meadow will not carry young stock.

There is no better site for a farm than where the ground has a gradual slope towards the south or south-west, thus permitting of natural drainage and thereby increasing the soil temperature. The ill effects of allowing cows to lie out at night is very largely dependent upon whether they are lying on wet, cold, and exposed ground, or whether they are well sheltered with a warm soil beneath them. If a bed or layer of leaves be provided in the field, or park, in which the cows are lying out in winter, they will take advantage of this additional comfort, and nothing could be warmer or better suited to resist the cold damp air from the ground coming in direct contact with their bodies.

Land facing north is always cold (see Fig. 8), and grass is late in growing in consequence, the ripening of cereal crops is delayed, and so the operation of harvesting is frequently overtaken by bad weather. Grass grows sparingly in high as compared with low altitudes, and it is important to a dairy farmer that bulk as well as quality of herbage should be secured, otherwise the number of stock must be reduced, or he must grow fodder crops to supplement the shortage of grass.

*Water-supply.*—A good supply of pure water is essential to success in dairy farming. Nothing is more detrimental to dairy cows than for them to have to rely upon stagnant pools, duck ponds, and ditches for their supply of water, and they readily partake of the liquid in these places if they are not railed out of reach.

In many instances what might prove to be useful drinking pools are rendered unfit for use by allowing overhanging branches to shade them, which shut out every ray of sunlight, thereby ensuring a perfect condition for the breeding and well-being of myriads of the lower forms of animal and vegetable life. In hot weather when cows are troubled with warble and other irritating flies, they instantly make for the nearest pool or stream, and thus assist somewhat directly in

the process of pollution, unless the water be that of a rapidly flowing stream or river with a gravel bottom, in which case the animals are cleansed instead of becoming besmattered with filth. When one sees cows' udders coated with a thick layer of filth as black as a sweep's soot-bag it is not difficult to realize how milk becomes contaminated, as no amount of washing prior to milking can cleanse an udder so begrimed.

In the washing of dairy utensils, clear pure water is of equal importance, so that in selecting or adapting a farm for dairy purposes a pure water-supply is undoubtedly one of the most important essentials.

**Selection of Stock.**—Many breeds of cattle are included among those suitable for dairy purposes, all of which have some special features or characteristics to commend them. The Shorthorns are most prominent among dairy breeds on account of their heavy milking capacities combined with fattening propensities, but in purchasing cows in the open market great care must be exercised, as a large percentage of heifers with their first calf show little signs of ever developing into really useful milch-cows.



FIG. 201.—Types of Teats.

A heifer can usually be best judged after her second calving, but here it may be remarked that very few dairy farmers sell their best cows, and many which are sent to market with a second or third calf at foot are sold because of some fault, and one which may not be discovered by any external examination. Thus, if a guarantee cannot be obtained as to the animal's fitness, it is much the better plan to select such heifers with a first calf as present a good appearance.

A good dairy heifer or cow of any breed should be somewhat wedge-shaped, that is, with the lines of the body converging towards the front quarters from whatever point the animal is viewed. Prominent milk veins, with an udder reaching well under the animal and well out between the hind-legs, are also essential, together with well-shaped teats placed squarely on the udder (Fig. 201). The hindquarters should be heavy, with a good length from the loins to the setting on of the tail, and the greater the distance across the loins the better. The hind-legs should be well set apart so as to provide ample room for the expansion of the udder. The distance between the fore-legs, and the height of the fore flanks are of minor importance, but the higher the hind flanks are the better, as this will permit of the udder distending sideways. A delicate, slender-looking neck, the veins of which stand out well, should also be looked for. The ribs

should be well sprung, and the barrel broad and deep. The face should either be straight, as in the case of a dairy Shorthorn, or dished, as in the Jersey, but never raised in the centre so as to give the impression of a Roman nose. One often hears the term "bull-headed heifer", which denotes an animal passable probably in many other respects but having a coarse bull-like head. Such animals are usually of the fleshy type, and rarely ever prove heavy milkers. The shape of the animal's head, and the expression of the face must be carefully noted; the head should be typical of the breed.

In obtaining a knowledge of the different breeds, the student cannot do better than go carefully through the various classes at any of our large shows, such as those of the Royal, Royal Counties, Bath and West, and other agricultural societies, as there is no better method of becoming familiar with typical breeds of live stock.

The student must not go to market with the expectation of seeing a cow possessed of all the above characteristics; but he will do well to use his powers of observation, and as each cow comes into the sale ring fix what he considers her value, so that if the bidding goes below or above his estimate he may try and ascertain the cause. Above all, it is well to note how expert dealers and buyers inspect the cows outside and in the ring, giving special attention to the udder and condition of the milk by drawing the teats.

In size and shape of body the Ayrshire may be regarded as an example of a typical dairy cow, and a careful study of her "points" will serve as a guide in studying other dairy breeds.

	POINTS.
<b>HEAD</b> . . . . .	<b>8</b>
Forehead—broad and clearly defined . . . . .	1
Horns—wide set on and inclining upward . . . . .	1
Face—of medium length, slightly dished, clean cut, showing veins . . . . .	1
Muzzle—broad and strong without coarseness, nostrils large . . . . .	1
Jaws—wide at the base and strong . . . . .	1
Eyes—full and bright with placid expression . . . . .	2
Ears—of medium size and fine, carried alert . . . . .	1
<b>NECK</b> . . . . .	<b>3</b>
Fine throughout, throat clean, neatly jointed to head and shoulders, of good length, moderately thin, nearly free from loose skin, elegant in bearing . . . . .	3
<b>FOREQUARTERS</b> . . . . .	<b>11</b>
Shoulders—light, good distance through from point to point but sharp at withers, smoothly blending into body . . . . .	2
Chest—low, deep, and full between and back of fore-legs . . . . .	6
Brisket—light . . . . .	1
Legs and feet—legs straight and short, well apart, shanks fine and smooth, joints firm; feet medium size, round, solid, and deep . . . . .	9

Carried forward . . . . . 22



	POINTS.
	<i>Brought forward</i> . . . . .
	22
<b>BODY</b> . . . . .	13
Back—strong and straight, chine lean, sharp and open jointed . . . . .	4
Loin—broad, strong, and level . . . . .	2
Ribs—long, broad, wide apart, and well sprung . . . . .	3
Abdomen—capacious, deep, firmly held up with strong muscular development . . . . .	3
Flank—thin and arching . . . . .	1
<b>HINDQUARTERS</b> . . . . .	11
Rump—wide, level, and long from hook to pin bones, a reasonable pelvic arch allowed . . . . .	3
Hooks—wide apart and not projecting above back nor unduly laid over with fat . . . . .	2
Pin bones—high and wide apart . . . . .	1
Thighs—thin, long, and wide apart . . . . .	2
Tail—long, fine, set on level with the back . . . . .	1
Legs and feet—legs strong, short, straight when viewed from behind, and set well apart; shanks fine and smooth, joints firm; feet medium size, round, solid, and deep . . . . .	2
<b>UDDER</b> . . . . .	20
Long, wide, deep, but not pendulous nor fleshy; firmly attached to the body, extending well up behind and far forward; quarters even; sole nearly level and not excessively indented between teats, udder veins well developed and plainly visible . . . . .	20
<b>TEATS</b> . . . . .	12
Evenly placed, distance apart from side to side equal to half the breadth of the udder, from back to front equal to one-third the length; length $2\frac{1}{2}$ to $3\frac{1}{2}$ inches and not less than 2 inches, thickness in keeping with length, hanging perpendicular and slightly tapering, and free flow of milk when pressed . . . . .	12
<b>MAMMARY VEINS</b> . . . . .	5
Large, long, tortuous, branching and entering large orifices . . . . .	5
<b>ESCUTCHEON</b> . . . . .	1
Distinctly defined, spreading over thighs and extending well upward . . . . .	1
<b>COLOUR</b> . . . . .	2
Red of any shade, brown, or these with white, mahogany and white, black and white, or white; each colour distinctly defined. (Brindle markings allowed but not desirable.) . . . . .	2
	<hr/>
	<i>Carried forward</i> . . . . .
	86

	<i>Brought forward</i>	POINTS.
COVERING . . . . .	86	6
Skin—of medium thickness, mellow, and elastic . . . . .	3	
Hair—soft and fine . . . . .	2	
Secretions—oily, of rich brown or yellow colour . . . . .	1	
STYLE . . . . .		4
Alert, vigorous, showing strong character, temperament mild . . . . .	4	
WEIGHT at maturity from 800 to 1,000 lb. . . . .		4
	Total . . . . .	100

The "escutcheon" (Fig. 202) is the area of hair enclosed by the fringe formed by the hair on the udder and thighs of the cow growing in two different directions. A scheme was formulated, known as

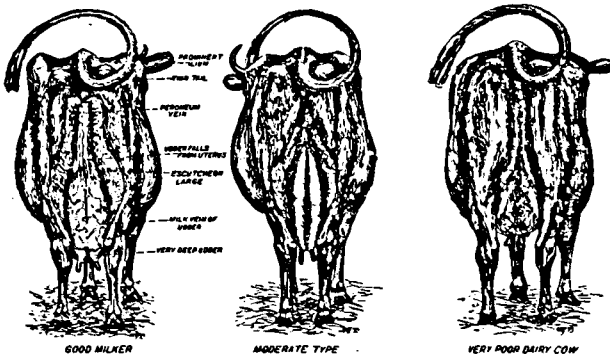

FIG. 202.—Types of Escutcheons.

the "Guenon System" after its inventor, whereby the shape and distinctiveness of the escutcheon forms some criterion of the milking capacities of the animal, and while by no means an infallible guide it is undoubtedly useful for purposes of selection, if a thorough knowledge of the whole system is acquired. As a general rule, the broader the escutcheon is on the thigh the larger will be the milk yield, while the higher it extends the longer will the cow continue in milk.

Large numbers of maiden and in-calf heifers are now annually purchased at spring sales for calving down during late autumn and winter. In making a selection of these, avoid those which have been stunted and starved during the winter, as indicated by their dwarfed appearance, and the tightness of the skin covering their ribs. Keep in view as much as possible the points of a good dairy cow, and see that the hair is abundant and glossy, and the skin elastic and

kind to the touch. An animal, like a plant, when once stunted and starved can never make up such loss by liberal feeding afterwards, and it is often a difficult matter to induce healthy growth and development. Overfed stores are not desirable, as besides being expensive to purchase, it is difficult for any ordinary farmer to keep them up in condition, neither is it desirable to do so, as animals intended for dairy purposes, and especially when nearing calving, must not carry too much loose flesh.

*Milk Yields and Milk Records.*—The object of the farmer who produces milk for the wholesale market is to secure the greatest possible quantity of pure clean milk per cow, and of such quality as attains to the Government standard of 3 per cent of fat and 8·5 per cent of solids other than fat. The heavy milking types of Shorthorns and Ayrshires answer these requirements admirably, animals of both breeds frequently giving over 1,000 gallons of milk during lactation or the milking period. In conducting milking trials at some of the leading shows the writer has frequently been obliged to disqualify some of these heavy milkers on account of their milk being below the 3 per cent standard of butter fat, in some cases only 2 per cent having been registered. Jerseys, which are renowned for their high percentage of butter fat, not infrequently fall below the standard; for example, one of Lord Rothschild's Jerseys, Twylish XI, was disqualified at the milking trials at the Bath and West Show, in 1912, because the fat percentage of her milk yield (62·125 lb. = 6 gallons) fell below the standard of 3 per cent. These instances are merely mentioned to illustrate the fact that in all breeds the quality of the milk is exceedingly variable, and usually the greater the quantity produced the poorer the quality.

Students must take advantage of any opportunity of testing and comparing the fat content of morning's and evening's milk, also that first drawn from the udder and that which is last drawn, or what is commonly known as "strippings". A careful comparison will show that the evening's milk will be richer by about 1·5 per cent, and the first-drawn milk may contain only 1·5 per cent of fat, and the strippings 6 per cent or more. When the milking is done twice a day at intervals of, say, exactly twelve hours, the composition of the two milkings will be very similar, but when there is a difference in the time of the two milkings, then the milk produced over the longer period will be the poorer, the morning's milk often failing to reach the 3 per cent standard.

If a good milking herd is to be built up, it is essential that calves should be selected from good milking dams, while the sire should also be traceable to a heavy milking dam or grand-dam. When the very best selections have been made, a calf having been saved from a dam and grand-dam yielding an average of 1,000 gallons of milk per annum, with a like record on the part of the sire's dam or grand-dam, the progeny may not give a yield beyond 600 or 800 gallons per annum, or it may considerably exceed 1,000 gallons. In any case, however, the above lines of selection are the proper ones on which to work, as often too little attention is paid to the milking properties on the side of the sire, and in breeding for either beef or milk the fact remains

true to-day as it did one hundred or more years ago, namely, that the bull represents half the herd. Nothing could be more detrimental to success than to mate a deep milking Shorthorn cow with a typical beef bull with the hope of increasing the milking properties of the offspring.

Every dairy farmer should keep a record of his herd, and the milk produced by each animal, throughout the year, a practice which involves very little expenditure of time or money, yet possesses considerable advantages, inasmuch as the records give a correct account of each animal's performance during the year, and thus assists the farmer in selecting or retaining only the animals which prove profitable. There is nothing new about the present-day system of milk recording, as it has been practised on many dairy farms for generations, except that in recent years the quantity of butter fat in the milk is also estimated and recorded by the Gerber tester.

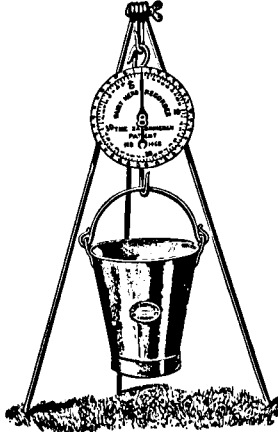

FIG. 203.—Herd Recording Balance.

The only appliances or outfit needful for milk recording are a clock-faced balance with pail, for hanging in the cow byre (Fig. 203), or it may be suspended from a tripod, when it can be easily moved from one cow-house to another, and a pad of record sheets on which the morning's and evening's milk yields of each cow may be entered against her name at the time of milking, when at the end of the week the sheet may be torn off and the yields entered into a milk record book (Fig. 204). If the fat content is also to be estimated a small Gerber fat tester and a sample bottle for each cow will also be required.

**Cow-houses.**—What are known as "model" cow-houses are altogether too elaborately fitted for the average dairy farmer; in fact, stock do not thrive any the better for such additional expense in housing. In the South of England excellent cow-houses exist which



The urine should be effectively dealt with by the material used as litter, or may be directed underground to meadows where it can be irrigated over the land, although the drains are frequently liable to choke. No underground drain, however, must exist within the building, and that outside must be well trapped.

Very substantial cow-sheds can be built at a cost of about 3*d.* per cubic foot or about £8 per cow, while others less durable but equally comfortable and sanitary are erected at a much lower figure.

*Walls and Roof.*—In the erection of a substantial building good brick or concrete walls are best, although wood on brick, or concrete foundations make quite substantial buildings. There is, however, greater danger in case of fire. Brick or stone walls should be pointed outside and plastered inside, or faced with smooth bricks or cement. Brick walls should be of a minimum thickness of 9 inches. Whatever the inside surface, it must be of such a nature as to admit of its being easily whitewashed, there being no cleaner or sanitary method of dealing with inside walls. There is no cleaner surface than that provided by well-glazed bricks, but these are much too expensive for ordinary use. The top of the walls should be beam-filled to prevent the accumulation of dust. Coloured cement is sometimes used up to 6 feet above the ground-level.

Roofs of cow-sheds should be constructed of well-seasoned wood, and covered with either slates or tiles. Many cow-shed roofs are now, however, covered with specially prepared roofing material, asbestos slates being commonly employed.

Roofs are best open to the ridge, and with no lofts erected over them. An open purlid roof with iron cross-bars will answer the purpose quite well.

*Floor.*—A good floor is the most important essential in a cow-house, as if not well laid it will crack and allow the urine to filter through into the foundations. Also, in order to prevent soakage-water accumulating under the foundations and working havoc, it is essential that the foundations be laid from 6 to 9 inches above the level of the ground outside.

Where material is plentiful locally, a good hard bottom may be made of well-rammed clay, chalk, or adhesive gravel, over which are laid 6 inches or so of broken stone or ballast, and then a 3 or 4 in. layer of cement concrete well rammed, and before it has set an inch or so of two parts of crushed gravel to one part of cement, and left with a slightly rough surface. When the surface is floated over and rendered quite smooth it is less liable to hold dirt, but, unfortunately, cows slip badly on it, and are apt to strain themselves.

The passages and rear portion of the stalls should be slightly grooved, as in addition to affording a better foothold this assists in draining and keeping the surface dry. It is often found that a well-washed road grit, or silver sand mixed with cement, in place of the commoner grades of building sand, produces a much quicker drying surface. Unless cement floors are well bedded with straw, they are very cold for cows to lie upon, and for this reason that portion of the bed which comes in direct contact with the body of the cow is often

made of well-rammed clay or chalk, both of which are warmer than cement, while in some instances wood or cork brick beds are used, but none of these substitutes are so clean and durable as cement.

*Gutters.*—If cows are to be kept reasonably clean the gutters must be carefully constructed. They must have a fall in width as well as in length, in such a way that the urine will flow to the edge furthest from the animals and still more rapidly to the exit. The fall in width need not exceed 1 inch for a gutter 24 inches wide and 8 inches deep, while the fall in length may be as much as 1 inch for every 25 feet.

It is very important that the edge of the gutter should be square and not rounded or bull-nosed, as in the latter case the cows when being milked will often work their feet towards the edge and slip, whereas if the edge is sharp the foot is sufficiently sensitive to detect this, and so it is observed that cows will frequently stand with their feet quite firmly on the extreme edge. Rather than have a deep

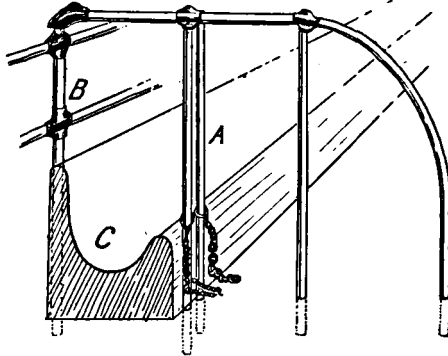

FIG. 205.—Tubular Iron Cow-stall Division.

gutter of only medium width it is preferable to have one quite shallow, or merely dished out, and of ample width.

*The Manger.*—Much difference of opinion exists as to whether the manger or feeding trough should be low on the ground or raised some distance above it. Having tried both positions, we find that although the low manger has many advantages and admits of the cows lying down with their heads well over it, a high manger, so constructed that the heads of the cows cannot be pushed forward when lying down or standing, tends to keep the animals cleaner. A manger of a medium height is useless, as when the cows rise and move their heads forward they soil their beds and consequently soil their udders when lying down.

The manger may be of wood, stout elm for preference, or a half-round glazed two-foot pipe, slightly tilted in a setting of cement. When cows are fed with sloppy foods, such as brewers' grains, fire-clay troughs, one for each cow, are often used, measuring 20 inches long

by 16 inches broad and 8 inches deep, with a capacity of from  $3\frac{1}{2}$  to 4 gallons. Whatever the type of trough used there must be no crevices for food to drop into, where it will decay and give rise to objectionable odours. There are now on the market many patent automatic drinking and feeding troughs.

*Watering.*—Many of the patent automatic combined watering and feeding troughs, apart from being expensive, are unsuited for ordinary purposes. The best device of the kind is where each cow is allotted her own drinking basin and where the tap can be turned off or on at leisure, as when the flow is continuous throughout a channel embedded in the manger there is risk of contamination and infection, unless a very strong current of water keeps the pipe well flushed.

Where cows can be supplied with plenty of good water out-of-doors there is very little need to incur the expense of an indoor supply.

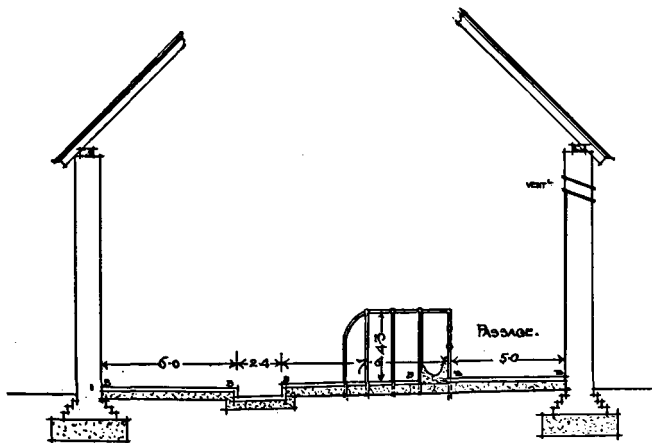

FIG. 206.—Section of Cow-house, with one row of stalls and feeding passage.

The best supply of water is by gravitation from a spring at a high level which is thoroughly reliable, or from clear running rivers, streams, or lakes. In some instances it is necessary to store the water in tanks at such heights as will admit of sufficient pressure being obtained in the cow-shed, dairy, and elsewhere.

*Partitions.*—As already remarked, it is possible to safely house cows without any partitions dividing one from the other. Cumbersome partitions only tend to increase labour, harbour dirt, and very often result in water finding its way into the foundations when they become loosened, or in the case of wood they rot at the base. If partitions are desired, by all means let each cow have its own stall, the partition allowing ample space for the milker.

A modern form of partition is that of "reinforced" concrete, i.e. a slab of concrete with tubular rods embedded in it, and set on



edge. In many cow-sheds where the animals are stalled in couples, concrete divisions, 4 ft. 6 in. long, 4 feet high, and 3 inches thick, are used, but plain tubular iron piping (Fig. 205) is more sanitary and easy to clean and also admits of a very free circulation of air.

*Lighting and Ventilation.*—An adequate supply of light and ventilation must be provided in every cow-house if the animals are to be maintained in good health. Windows should be placed fairly high in the walls, and should be of the Sheringham valve type, opening inwards. Glass tiles let into the roof at intervals are admirable in every way for lighting a cow-shed. If possible, the window area should average 3 square feet of glass per cow. Another suitable type of window is one the upper part of which is glazed with strong rough plate-glass, and the lower part fitted with fixed bars and a slanting framework of bars to close the apertures as desired.

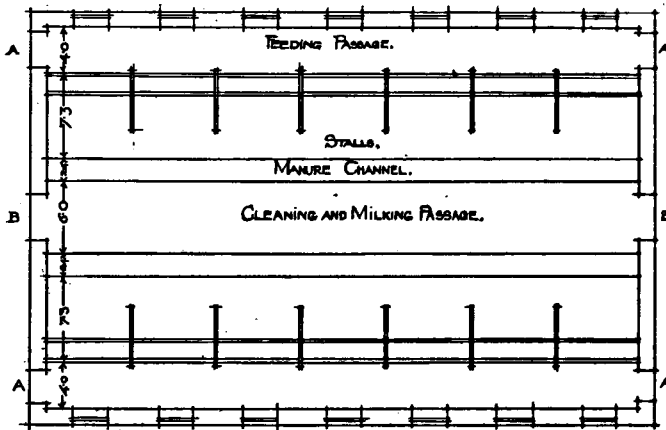

FIG. 207.

No system of ventilation can be considered perfect unless it serves two purposes, namely, expelling the polluted air which arises and substituting pure air from outside. In some instances ventilation may be provided by louvre boards, or boarded openings along the ridge, and by openings at the eaves, but in sheds of better construction more definite systems of ventilation are necessary.

The inadvisability of cows breathing against a wall in such a way that their breath is reflected back on their faces has already been pointed out, and to obviate this defect it is necessary to insert a fresh-air inlet through the wall near the nose of each cow; zinc of fine mesh being placed on the outside to reduce the force of the draught, and a shield placed over the inside of the hole to deflect the current of air. Perforated bricks, drain pipes set with an upward tilt, or metal gratings will answer the purpose. The outlet ventilation must be similarly self-acting and equally simple.

It has been estimated that an average cow weighing 1,000 lb. will inhale 224 lb. of air in twenty-four hours, or about double the amount by weight of her food and drink. This is at the rate of 3,542 cubic feet per hour, and to supply this amount of air for twenty cows a ventilating flue 2 by 2 feet will be required, in which the air must move at a velocity of 295 feet per minute.

*Stalls and Gangways.*—The length of the stall will vary with the breed of cow, remembering always to take the measurement from the front wall—not from the near side of the manger—and to the inner edge of the gutter. Small-bodied cows like the Jersey and

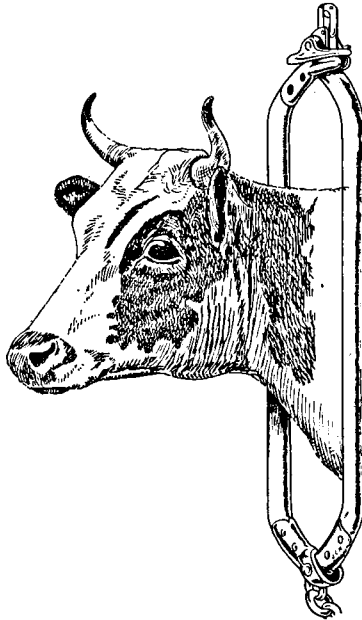

FIG. 208.—Diagram illustrating use of Iron Stanchions.

Kerry should have stalls from 6 feet to 6 ft. 9 in. in length; for Ayrshires and Guernseys a stall from 7 feet to 7 ft. 6 in. will suffice, while for big-framed Shorthorns quite 8 feet must be allowed. It is impossible to arrange a length to suit all the cows in a mixed herd, without, of course, making the stalls to graduate in size, as is sometimes done, say, from 8 to 7 feet. If the stalls are too short the cows will stand with their feet in the manure channel, and when lying down the hindquarters will be unsupported, which is sometimes conducive to abortion.

If the stalls are too long, the cows drop their manure on the standing space, and in lying down soil their udders and thighs.

As regards width, each cow will require from 3 to 3½ feet and larger cows up to 4½ feet each, and rather less in proportion in the case of double stalls. If the stalls are too narrow, one animal may trample upon another's udder or teats, and so cause considerable harm, while if the stalls are too wide the cows can turn round, soil the bed, and prevent another animal from lying down.

*Floor-space.*—The floor-space must never be cramped, and must be to a great extent regulated by the number and breadth of the various passages or gangways; the stalls, mangers, and manure passages being fixed areas. A feeding passage cannot reasonably be less than 3½ feet wide, and the passage behind the cows 4 feet. These dimensions will give about 50 square feet for small cows, and more than 60 square feet for larger ones. In a cow-shed with only one passage in which to perform all the necessary operations of feeding, milking, etc., this should not be less than 5 feet wide, while in some of the large partitionless sheds, already referred to, the centre passage is 7 feet wide.

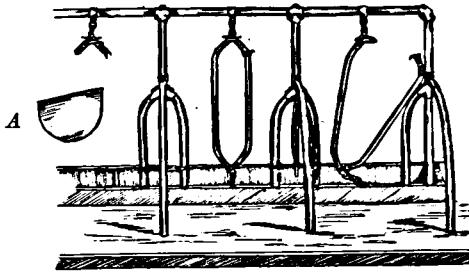

FIG. 209.—Cow-stalls fitted with Iron Stanchions. A, section showing trough division.

The accompanying sectional plan (Fig. 206) will suffice to give the student some idea of the dimensions of a shed fitted with a single row of stalls, while for a double row (Fig. 207) it is only necessary to increase the breadth of the centre passage, and construct a second row of stalls on similar lines to those shown.

*Neck Fastenings.*—Farmers differ in their opinions as to the best and most economical method of tying up cows in the stalls. In a few farms in Hampshire the old wooden bales are still in existence which in former years were largely used for dairy as well as for fattening cattle. This method of securing the animal possessed the inhumane disadvantage of not allowing it to move its head towards its body to allay any skin irritation or other temporary trouble.

The swinging iron stanchions (Fig. 208) which originated in America, and are now common in this country admit of freedom of movement. These neck yokes can be so arranged that by drawing a lever a whole row of animals can be instantly released in case of fire (Fig. 209), a great advantage over ordinary chains and other

fastenings which cannot be readily removed from the neck of a frightened animal.

Straps have one great advantage, inasmuch that should a cow get hung up, and likely to be choked it is often impossible to release a chain through the pressure upon it, whereas a strap can instantly be severed with a knife. Whatever form of neckgear is used it must be so adjusted as to restrict the cow's movements to the space allotted to it, so that it cannot trespass upon its neighbour's preserves.

## MILK.

Milk is the normal product of the mammary glands (Fig. 210) of a healthy cow, and may be regarded as one of the most important of all natural foods, constituting, as it does, the entire dietary of all mammals for some time after their birth. It is easily assimilable and

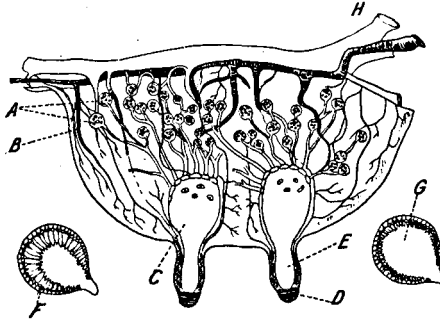

FIG. 210.—Section of Cow's Udder and enlarged Alveoli. *A*, gland lobule; *B*, alveoli; *C*, milk cistern; *D*, sphincter muscle; *E*, milk duct; *F*, enlarged epithelial cells as when giving milk; *G*, the same, when not giving milk.

is a complete food, as it contains all necessary constituents for the maintenance and development of the animal body.

Milk is a whitish, opaque fluid, possessing a mild, sweet flavour. It has an average specific gravity of 1.032, which varies in accordance with the proportion of solids it contains, and is slightly viscous. Its opacity and viscosity are due to the fat and caseous or curdy matter which are present in suspension. The whiteness of milk is due to casein, and its yellowness to the fat, which contains a colouring matter, lactochrome, somewhat analogous to the chlorophyll of plants. Thus, if the fat is removed by separation, the skimmed or separated milk is considerably paler in colour than the whole milk. The boiling-point of milk is practically 212° F., and its freezing-point 30° F.

Chemically, milk consists of water, fat, casein, albumen, sugar, and ash, all of which vary slightly in quantity, but chiefly in the proportions of water and fat, and in the case of the latter the fluctuations are largely due to breed and individuality.

Average samples of new milk, separated milk, and colostrum will contain the above constituents in the following proportions :—

	New Milk. Per cent.	Separated Milk. Per cent.	Colostrum. Per cent.
Water . . . .	87.5	90.4	72.0
Fat . . . . .	3.25	0.1	3.5
Casein . . . .	3.5	3.2	4.5
Albumen . . . .	0.5	0.6	1.60
Sugar . . . . .	4.5	4.9	2.5
Ash . . . . .	0.75	0.8	1.5
	100.00	100.0	100.0

(Colostrum, or first milk, is secreted in the udder of the cow about the time of calving, and its composition renders it eminently fitted for the first nourishment of the calf, and it also possesses valuable aperient properties.)

With regard to the constituents of milk :—

The *water* is identical in chemical analysis with ordinary water, and cannot be distinguished from it. Its chief purpose in the animal body is to act as a vehicle for conveying or carrying all the other constituents into the circulation. The quantity of water present is to some extent affected by feeding and is increased by succulent and watery foods. There is usually a flush of milk when the cows are put out to grass in spring, and this milk is usually poorer in fats than that yielded at a later period.

*Fat* is perhaps the most important constituent of milk, as the yield of butter depends entirely upon it, as well as the quality of the best cheese. Fat is present in milk in the form of minute globules (Fig. 211), formerly thought to be surrounded by an envelope (Storch's theory), but this has now been proved to be erroneous. These globules are invisible to the naked eye, and vary in size according to the breed of the cow, the largest being found in Jersey milk, and they measure about 0.00039 in. in diameter. The fat in milk may be separated into eight species, which are classified as volatile and non-volatile, as follows :—

<i>Volatile and Soluble Fats.</i>	<i>Non-Volatile and Insoluble Fats.</i>
Caprin.	Palmitin.
Caproin.	Myristin.
Capryllin.	Stearin.
Butyrin.	Olein (liquid).

The olein keeps the remaining fats in a soft or semi-fluid condition, and is present in the proportion of from 30 to 50 per cent of the total fat content.

*Casein* is the chief nitrogenous, or albuminoid, constituent of milk. It is semi-soluble in water or milk, forming a colloidal or glue-like mass. It is coagulated by rennet, and then forms an insoluble substance known as "curd", which is the characteristic constituent of cheese. An excess of any acid will also produce a "curd", but it may not always separate out from the whey.

*Albumen* is a substance similar in composition to casein, being also an albuminoid, or flesh-former. It is soluble in water, and ready digested for the stomach of the young, and colostrum contains a large amount of it. Albumen also differs from casein in not being coagulated by rennet or acid, but it is by heat. It escapes from cheese in the whey. In ordinary new milk, albumen coagulates at a temperature of 163° F., forming the familiar "skin", or pellicle, on the surface of cooked milk, in which many of the fat globules are entangled

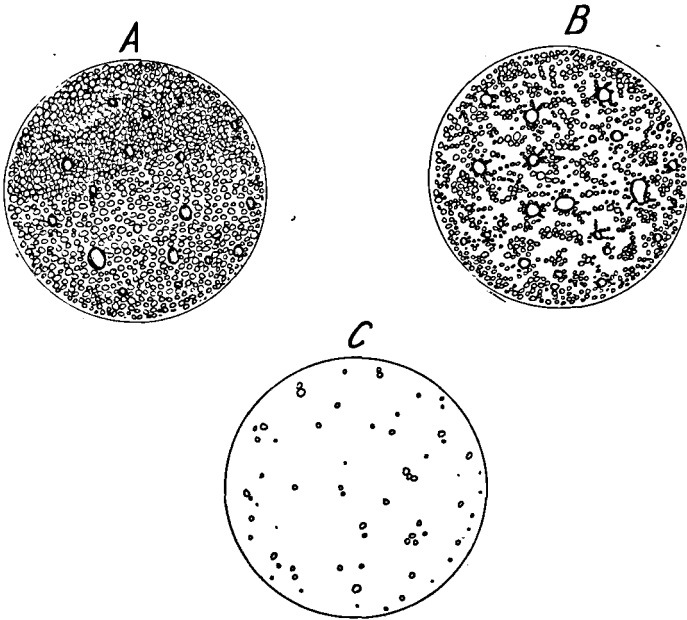

FIG. 211.—Microscopic appearance of Fat Globules. A, cream 12% fat; B, whole milk 3.6% fat; C, separated milk 0.2% fat.

*Milk Sugar, or Lactose*, is a carbo-hydrate, or heat-producing, constituent, only found in milk or its products. It also differs from other sugars in being less soluble in water. It largely escapes in the whey during cheese-making, and can be recovered in the form of colourless crystals, of low-sweetening power. It readily ferments, and is decomposed by the action of certain bacteria, forming lactic acid. This change constitutes the ordinary souring of milk.

*Ash* chiefly consists of mineral matter derived from the soil, and exists partly in solution, and partly in suspension in milk. The chief purposes of the phosphates and various salts comprising it

are the formation of bone and brain ; hence the comparatively large proportion of this constituent present in colostrum.

Influences affecting the Quality and Yield of Milk.—*Breed.*—The yield and quality of milk differ very considerably in the case of different breeds of cows, as will be seen from the following average yields and fat percentages of the chief dairy breeds:—

	Yield per annum. Gallons.	Fat per cent. by weight.
Dutch . . . . .	800	3·4
Shorthorn . . . . .	650	3·7
Ayrshire . . . . .	600	3·7
Guernsey . . . . .	500	4·5
Devon . . . . .	500	4·0
Jersey . . . . .	450	5·3

*The Lactation Period* usually lasts for about 300 days. Milk from newly-calved cows does not become normal until ten days after calving, and from the tenth to the fortieth day it varies little in either quantity or quality. After the fortieth day, the yield gradually declines, but this is accompanied by an increase in the fat percentage. For this reason it is usual at milking trials to allow 1 point for every ten days since calving, after the first forty days.

*The Age of the Cow* has considerable influence on the quality of the milk, and to a lesser degree on the quantity. A dairy cow may be considered as at her prime from her third to her fifth calf, when both quantity and quality of her milk will be at a maximum. The quantity will then undergo little change until the tenth calf, when it will gradually decline, while the variation in quality will be only small. It is never policy to keep a dairy cow in the herd after her sixth calf, unless she possesses an exceptional milk record, and throws specially good stock.

*Individuality* is found to be one of the most important causes of variation in the quantity and quality of milk, and it is for this reason that milk records should always be kept in order to ensure the retention of the best animals, and the "weeding out" of those of inferior quality.

*Feeding* is chiefly responsible for variations in yield, and generally the more succulent and watery the dietary the larger will be the yield of milk. Each cow innately possesses the faculty of producing her maximum quantity of fat, provided her ration is such as will enable her to maintain it. It is found impossible to increase this fat-content by any method of feeding during lactation. If, on the other hand, her ration is such as does not admit of her attaining her maximum, then the use of dry, concentrated foods, particularly those of an albuminous or nitrogenous character, will usually effect an increase in the fat content, although it may prove detrimental to yield (see Diets).

*The Seasons of the Year.*—Milk is most liable to fall below the Government standards of solids not fat, in early spring and autumn, as at both these periods an excess of watery and innutritious food is consumed, and chilly nights prevail. Consequently the cow requires

more of the nutrients contained in her food to maintain the normal warmth of the body, and this results in a decrease in the quality of the milk.

*General Treatment of Cows.*—Good animals, kept clean, comfortable, and free from excitement, will yield the best possible results in milk. On the other hand, where cows are in ill-health or unduly excited, the milk is immediately affected. Especially is this noticeable in cows taken long distances to shows, and in such cases the fat content of the milk may fall as low as 2 per cent, or even less, whereas at home the quality would be normal.

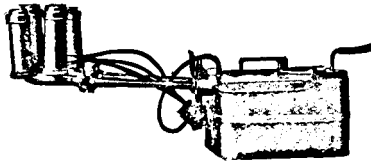

FIG. 212.—The "Amo" Vacuum Milking Machine.

*Milking.*—Quick milking, and clean stripping, increase both yield and quality by stimulating the milk-secreting glands. Careless milking, on the other hand, tends to dry off the cow prematurely and proves detrimental to the udder, as is noticeable in cows which are milked by novices.

*Treatment of Milk.*—*Bacteria in Milk.*—Bacteria (see Fig. 4) are in reality the lowest forms of plant life, and in milk they find a most congenial medium for growth and reproduction. So true is this that one drop of milk may contain as many as 3,000,000 of these organisms.

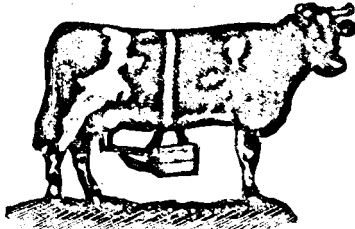

FIG. 213.—"Amo" Milker fitted to Cow.

From a dairying standpoint, and with regard chiefly to the manufacture of butter and cheese, these bacteria may be considered as either harmful or beneficial, so that one of the first essentials in dairy practice is to keep the milk, or cream, free from contamination, and to carefully cultivate the latter class for the production of butter and cheese of the required quality. Beneficial bacteria consist of species producing pure lactic acid from the milk sugar, and pure cultures of them, in the form of "starters", are utilized for inoculating milk



or cream for cheese- or butter-making respectively, so that they may develop and obtain the upper hand, as it were, to the exclusion of all those organisms of an undesirable or deleterious character.

Where milk has to be sold either wholesale or retail, it becomes necessary to manage it so that it remains sterile and free from germ life, and this can only be attained by constant attention to hygiene in the housing, care, milking, and in the after-treatment of the milk. The need for this is even more strongly emphasized when we remember that numerous epidemics of scarlet fever, diphtheria, and typhoid have been directly traced to impure milk, and it has now been definitely settled by scientists that milk may also be a means of transmitting the dreaded scourge of tuberculosis.

*Methods of Milking.*—Of the two methods of hand-milking, namely dry and wet, the latter, although yet by no means obsolete, is to be



FIG. 214.—The "Manus" Pressure type of Milking Machine attached to Cow.

depreciated, necessitating as it does the damping of the hands of the milker with water, or, unfortunately, more often with milk. Any dirt or perspiration from the udder of the cow or the hands of the milker in this way inevitably become mixed with the milk and prove a dangerous source of contamination. By dry milking, on the other hand, this danger is obviated to a large extent, and even if dirt falls into the milk it is of a dry character and can be more easily got rid of by careful straining.

Mechanical milkers of the most modern type compare favourably with ordinary hand-milking, and, although numerous disadvantages exist in the older machines, these have now been to a large extent eliminated. For example, the chief defects of the ordinary vacuum action machine with teat cups, were (1) the difficulty of preventing the teat cups from falling off at awkward moments, (2) the necessity

of hand stripping after the machine, (3) more rapid decline in milk than where the cows were milked by hand, and (4) difficulty of quickly and efficiently cleansing the machine. Most of these defects, however, are got rid of in the most modern vacuum machines (Figs. 212, 213). Others extract the milk wholly on a pressure principle (Figs. 214, 215), without suction action, thus doing away with the necessity of teat cups, and unhygienic and cumbersome tubes. The teats of the cows are gently pressed by two softened convex plates, which are applied regularly on both sides by means of a simple spiral mechanism. The milk is then conducted a distance of a few inches to a receptacle directly under the cow, where it first passes through a



FIG. 215.—The "Manus" Milking Machine in use.

strainer. The machine fits tightly to the udder of the cow, and admits of the minimum risk of contamination. Nothing but practical tests will prove the merits of any particular machine, but when once these have been satisfactorily passed its success ought to be assured.

*Filtering and Cooling.*—As soon as the milk has been drawn from the cow, it should be removed from the cow-house, and immediately filtered or strained, preferably through double-wire gauze (Figs. 216, 217), between which a thin pad of sterilized cotton wool is placed, which may afterwards be thrown away. From the strainer the milk should be passed directly over a cooler, and thence to a milk churn below. The cooler or "refrigerator" (Fig. 218), as it is more

commonly and erroneously termed, consists of a series of copper tubes, tinned to prevent oxidation, inside which a stream of cold water passes, and over the outsides of which the milk is allowed to trickle. The churns usually contain 17 imperial gallons, and weigh 2 cwt. each when full.

**Effects of Heat on Milk.**—Bacteria propagate most rapidly at a temperature of from 80 to 100° F., and by raising or lowering the milk above or below these temperatures their increase may be promoted or checked. If milk is subjected for ten minutes to a temperature of 165° F. all growing bacteria will be destroyed. If followed by rapid cooling to a temperature of, say 45° F. the process is known as "Pasteurization", but while destroying all harmful organisms it is not sufficient to destroy their spores. A complete Pasteurizing and cooling plant is shown in Fig. 218.

The "sterilization" of milk, on the other hand, implies the destruction of all life in the milk, and this is effected by heating to a temperature of from 220 to 230° F. in sealed chambers under steam pressure (Fig. 219).

Apart from its effect on the bacteria of milk, heating is found to diminish its viscosity, and to impart to it a burnt flavour, noticeable



FIG. 216.—"Alfa"  
Milk Filter.

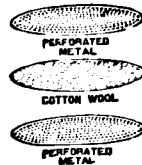

FIG. 217.—"Alfa" Milk Filter  
showing straining media.

in both Pasteurized and sterilized milk, and also in clotted cream, and the butter made from it.

This is due to the partial charring of the milk sugar, and the production of caramel. The creaming properties of the milk are also decreased by heating, owing to the breaking up of clusters of fat globules, and the action of enzymes of unorganized ferments (e.g. rennet).

Very low temperatures retard the growth of bacteria, and for this reason milk should always be passed over a cooler in a pure atmosphere directly after it is drawn from the cow.

At freezing-point (32° F.) the growth of bacteria is entirely checked, and on this account many large dairies are fitted with special cold stores and refrigerating machines, the action of which is dependent upon the alternate compression and expansion of either ammonia, sulphur-dioxide, or carbon-dioxide gas, which, in expanding from a liquid to a gaseous state, absorb a large amount of heat. The gas is made to pass through a tank of unfreezable brine, containing calcium chloride and salt, which becomes intensely cold, and may be used for maintaining a store of milk at a sufficiently low

temperature. It may also be made to circulate through pipes, coolers, etc., for the purpose of cooling milk or other liquid dairy products.

**Estimation of Fat in Milk.**—Having regard to the more universal keeping of milk records, and the necessity for all new milk to

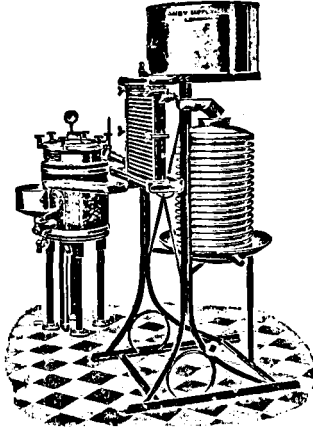

FIG. 218.—Pasteurizing and Cooling Plant.

comply with the Government standard of 3 per cent of fat, testing becomes of the utmost importance in dairying. This can be most conveniently effected by the Gerber process, by which all substances in milk are dissolved by the addition of strong sulphuric acid, the

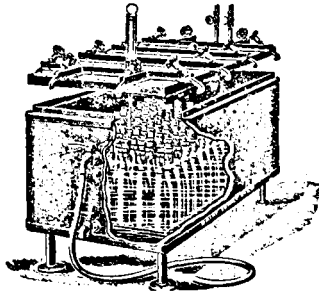

FIG. 219.—Milk Sterilizer (capacity 153 pint bottles).

fat alone being protected by means of a small quantity of amylic alcohol. The volumetric method of estimating the fat is briefly as follows:—10 c.c. of strong sulphuric acid are measured out by means of an acid pipette into a Gerber test-bottle (Fig. 220). 1 c.c. of

amyl alcohol is then measured out with the alcohol pipette, and gradually allowed to run on the top of the acid. Finally, 11 c.c. of the milk to be tested must be thoroughly mixed by pouring backwards and forwards from one vessel to another. It must be measured out with a milk pipette and allowed to trickle slowly on to the top of the alcohol. Or an automatic acid and alcohol measurer may be used (Fig. 221).

Opinions differ as to whether the milk, or the alcohol, should be first allowed to come into contact with acid, but if many tests are to be made it is preferable to put in the alcohol first, as there is then less risk of charring the milk.

The test-bottle is then tightly corked with an india-rubber stopper, and the contents are well shaken in the bulb end until all the curd has dissolved. The thumb should be kept tightly over the cork whilst



FIG. 220.—Gerber Test-bottle.

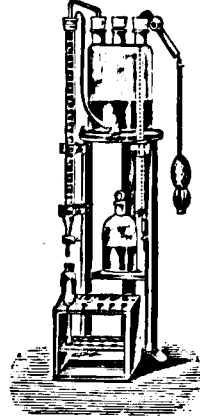

FIG. 221.—Veith's Automatic Acid and Alcohol Measure.

shaking, or it may be forced out, and the contents of the tube spilt. The test-bottles are then placed in the "centrifuge" (Fig. 222), a machine containing a number of horizontal pockets, care being taken to see that each tube is placed with the graduated end towards the centre of the machine, and balanced by having a tube placed opposite to it. Otherwise any odd tube must be balanced by one containing water. The tubes are then revolved in the centrifuge at a high speed for three minutes, after which it will be found that the fat has separated owing to its being lighter than the rest of the milk, and this fat will occupy the thin, graduated part of the tubes, the other heavier constituents occupying the bulb end. By careful manipulation of the rubber cork the percentage of fat may then be read off on the graduated part of the tube.

*Estimation by Weight.*—The above method of testing for fat is found quite satisfactory for all practical purposes, and is very similar to, but simpler than, the Babcock method, so largely used in America. Where absolute accuracy is required, as for example in legal cases, it becomes necessary to use the "Soxhlet" test, in which case a quantity of milk is absorbed by a strip of blotting-paper and

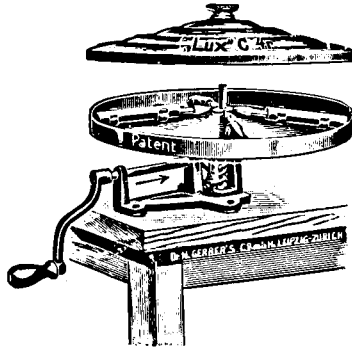

FIG. 222.—Centrifuge for four tests.

a fat solvent allowed to trickle over it (e.g. ether) until all the fat is dissolved, when the ether is evaporated and the fat actually weighed.

*Creamometers.*—Before the advent of more scientific fat-testing instruments the quality of milk was tested by means of creamometers (Fig. 223); that is, test-tubes graduated into 100 equal parts, so that, after resting the milk in these for a definite period, the percentage of cream could be read off. The drawback of the system,

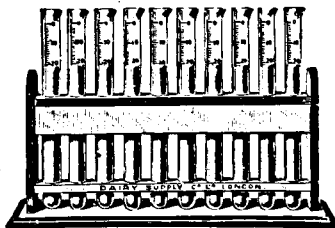

FIG. 223.—Creamometers.

however, is that the results form a very imperfect criterion of the actual fat content of the milk, as the consistency of the cream thrown up will depend largely upon the size of the fat globules and the setting temperature. These tubes can therefore be only satisfactorily used for comparative purposes, provided the milk is at the same temperature in each case—preferably from 90° to 100° F.

*Estimation of Water, total Solids, and Solids not Fat.*—A simple analysis of milk may be performed by evaporation and weighing. An evaporating dish containing a quantity of dry sand, for the purpose of preventing the formation of a scum on the surface of the milk, should be taken and weighed and a definite quantity of milk should be weighed into it. The dish and its contents should next be placed in a steam oven, and maintained at a temperature of 212° F., until no further evaporation of moisture takes place. The actual weight of water originally contained in the milk, and the total solids, may then be determined by weighing, and the percentages calculated.

After making a Gerber fat test of the milk, the percentage of solids not fat may be readily arrived at by subtracting the percentage of fat from the percentage of total solids.

*The Lactometer* is an instrument used for the purpose of ascertaining the specific gravity of milk. It is a modified hydrometer, and consists of a graduated glass stem (Fig. 224) attached to two glass bulbs, or cylinders, one below the other, the lower and smaller of the two being weighted to enable the instrument to float upright. It depends upon the principle that the weight of the instrument equals the weight of the volume of liquid it displaces. Thus, when placed in water at a temperature of 60° F., it will sink until the 0 side of the scale is on a level with the surface of the water (representing a specific gravity of 1.000). Placed in whole new milk at a temperature of 60° F., it should read from about 28 to 32, that is a specific gravity of from 1.028 to 1.032. The necessary correction for temperatures other than 60° F., is made by an allowance of 0.1 lactometer degree for every degree Fahr., remembering that the colder any liquid is, the denser it becomes.

Although undoubtedly a useful instrument, the lactometer must on no account be regarded as a reliable indicator of the purity of milk. For instance, if the specific gravity was shown to be abnormally low by the lactometer, this might be attributed to either the addition of water or to the presence of an unusual quantity of butter fat, both water and cream possessing lower specific gravities than whole milk.

Provided the lactometer reading is known, and the percentage of fat in the milk, the solids not fat may be conveniently estimated by the following formulæ:—

$$\text{Solids not fat} = \frac{G}{4} \text{ plus } \frac{F}{5} \text{ plus } 0.14,$$

$$\text{or solids not fat} = \frac{\text{lactometer reading plus fat per cent}}{4}$$

G = lactometer reading and F = fat percentage.

The specific gravity of cream may also be determined by the use of the lactometer, in which case the cream should first be diluted



FIG. 224.  
Lactometer.

with an equal weight of separated milk, and the specific gravity of the mixture obtained. The actual specific gravity of the cream may then be ascertained by multiplying the specific gravity of the separated milk by that of the mixture, and dividing the result by the difference between twice the specific gravity of the separated milk and the specific gravity of the mixture.

**Cream.**—Cream may be defined as that portion of the constituents of milk which rises and may be skimmed off, when the milk is allowed to stand for any length of time, or which may be separated from the remainder of the milk by centrifugal force by a mechanical separator. The chief constituent of cream, therefore, is the lightest part of the milk, i.e. the butter fat; and it will contain the remaining milk constituents in varying proportions, according to whether a larger or a smaller proportion of the actual fats are removed from the milk. As may be readily imagined, the percentage of fat in cream will vary considerably, on account of the many ways of preparing cream; for example, skimming may give cream of varying thickness, while from a separator either a thick or a thin cream may be obtained as desired. Moreover, from this it will be seen that the specific gravity of cream will also vary in accordance with the actual percentage of fat present, and in practice may be anything from 0.947 to 1.017.

The analysis of an average sample of what is commercially known as "double" thick cream would be approximately as follows:—

	Per cent.
Water . . . . .	40.6
Fat . . . . .	55.25
Sugar . . . . .	2.26
Casein and albumen . . . . .	1.5
Ash . . . . .	0.4
	100.0

The thickest cream obtainable will not contain more than about 72 per cent of fat, while for butter-making purposes a cream containing from 28 to 33 per cent is probably best.

In former years cream was obtained by setting milk in pans, allowing it to stand for a time, and then skimming off the cream. This system, however, has now been largely superseded by mechanical cream separators (see p. 449), although the pan-setting system is by no means obsolete. The different non-mechanical processes are as follows:—

1. Shallow Pans.
2. Deep Setting Pans.
3. Devonshire Creaming.

**Shallow Pans.**—These vary in size, but the usual dimensions are from 4 to 6 inches in depth and 18 inches in width across the tops. The milk is strained into these as soon as it is drawn, and left unstirred for twelve hours, at the end of which time the first cream is removed by means of a perforated skimmer. The milk is then left and skimmed at the end of another twelve hours, and, if the amount



of cream which rises is sufficient to warrant it still being left, it is skimmed once more after the lapse of another similar period. In the summer, however, it is preferable to skim at the end of eight, sixteen, and twenty-four hours, after setting. Provided the milk is exposed in a perfectly pure atmosphere, where there is no possible risk of contamination, the cream often produces butter containing a flavour unexcelled even by that produced from artificially-ripened separated cream, largely owing to the fact that the cream in the former case has become ripened in contact with the milk, and a larger surface has been subjected to aeration by pure fresh air.

*Deep Setting Systems.*—These methods have not been much used in this country, owing to the fact that they entail the use of very cold water, which it is difficult to obtain. The chilled water is circulated round deep pans containing the milk, so that the rapidly falling temperature may facilitate the rising of the cream. There are two kinds of pans, namely, Swartz and Coolie, the former holding from 10 to 11 gallons and being filled to a depth of about 14 inches, while the latter are fitted with a cover, and are totally immersed in water at a temperature below 48° F. Both these methods of cream raising are of American origin, and of the two, the Coolie gives the more satisfactory results—the resulting skim milk in some cases containing as little as 0.2 per cent of fat. There is, however, always a larger loss of fat if the milk loses its heat before it is set. The advantages of deep over shallow setting lie in the fact that more cream is obtained in less time, but the disadvantages lie in the difficulty of obtaining cold enough water in sufficiently large quantities, and the fact that the cream is not aerated, while in the case of the Coolie system “cowy” odours cannot escape.

*Devonshire Clotted Cream.*—The manufacture of Devonshire clotted cream attains considerable magnitude in districts where it is a popular dainty, and it is moreover a very refined product of high dietetic value. Apart from the raising of the cream by this particular method, the system of Devonshire cream-making is also adopted for the production of butter, as it affords a ready means of separating the maximum quantity of fat from the milk; and the butter produced possesses a distinctive flavour which is often greatly appreciated. Usually, however, a taste for this particular make of butter has to be acquired. The making of Devonshire clotted cream may be briefly described as follows:—

The milk is brought direct to the dairy, and after being carefully filtered, it is set in milkpans, the pans usually measuring 15 inches in diameter at the top, and 11 inches at the bottom, and are about 7 inches in depth. The cream will have risen sufficiently at the end of twelve hours in summer, or twenty-four hours in winter, and the pans and their contents are then carefully floated or fixed in a circular boiler containing water, which should be maintained at nearly boiling-point. The milk in the pans must be gradually raised to a temperature of from 175° to 180° F., in not less than thirty minutes, when the surface of the cream will become crinkled, and as soon as this has extended over the whole surface the pans may be removed from the boiler and cooled as rapidly as possible, preferably in running water.

The cream is then removed by means of a perforated skimmer, and is usually put up in 1 lb. and  $\frac{1}{2}$  lb tins or jars, which are retailed at from 1s. 4d. to 1s. 8d. per lb. tin.

When the cream is required for the production of butter, it is not advisable to heat the milk above 150° F., as otherwise the cream will contain a large proportion of albumen which has become coagulated and inextricably mingled with the fat globules.

If washing is not very thoroughly performed when the butter is in a granular state in the churn, the caseous matter will be noticeable in the form of white specks in the finished product, and these moreover, will quickly decompose and set up rancidity should the butter be kept for any appreciable length of time.

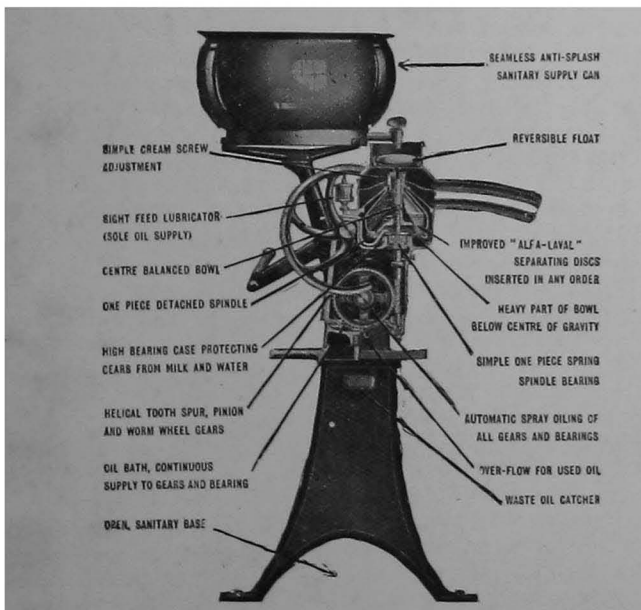

FIG. 225.—Section of the "Alfa Laval" Cream Separator.

**Cream Separators.**—Until recent years, gravity was the only force employed in the separation of cream from milk, and this was not very readily effected, being solely due to the difference in the specific gravity of the fat globules and that of the milk serum in which they are suspended. The smaller the fat globules the slower the rate of rising, owing to the resistance offered by the milk serum. The introduction of centrifugal force, however, causes the globules to move much more rapidly through the serum. In the first place, it causes bodies to be thrown off from the centre of motion, as instanced in the case of the familiar "joy-wheel". Moreover, it will be observed that heavier objects tend to be thrown farther from the centre than lighter ones.

The modern cream separator has been evolved on this principle, and admits of the cream being continuously and immediately separated from the milk. Lefelt was the first to perfect such a separator in 1877. Those who have visited the London Dairy Show must have been impressed by the great number of separators exhibited, most of which, however, with but few exceptions are very similar in device to the well-known "Alfa" type with supported bowl (Fig. 225), or the "Melotte" type with suspended bowl (Fig. 226). Although performing their work almost equally well, the duration of these machines depends very much on the quality of the materials used in their manufacture,

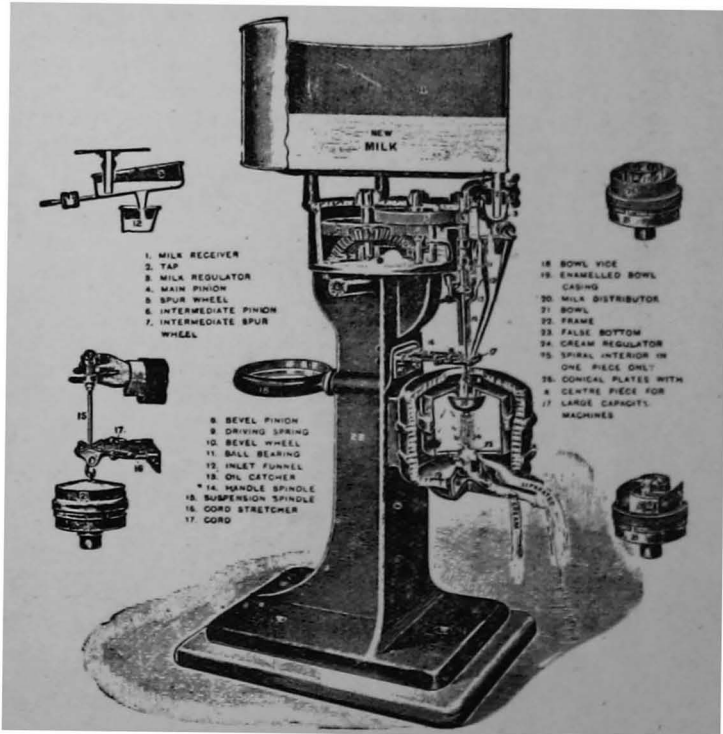

FIG. 226.—Section of the "Melotte" Cream Separator.

and the more expensive machines often perform satisfactory work for twenty or more years, provided that the worn bearings are replaced.

The bowl is the principal part of the machine, being that in which the milk is revolved and separation is effected. The milk being composed of liquids of different densities, the heavier part is thrown farthest from the centre of the bowl, i.e. to the outside, while the cream, being lighter, is unable to find its way through the milk serum and keeps in the centre of the bowl. The continual inflow of milk causes the cream and milk serum to rise through the outlets provided for them in the bowl, and they are then collected and carried

off by their respective ducts and pans. An essential principle in the construction of all separators is that of subjecting the milk to the greatest amount of centrifugal force in the least amount of time, so as to increase the separating power of the machine. Any dirt, slime, or bacteria in the milk which are of higher specific gravity than the milk serum are flung to the wall of the bowl, whence they are removed in washing.

The centrifugal force exerted increases as the square of the revolutions of the bowl, and directly as the diameter; thus a separator having a bowl 6 inches in diameter exerts twice the centrifugal force of one 3 inches in diameter, and a separator whose bowl revolves at the rate of 1,000 revolutions per minute exerts a centrifugal force four times as great as one revolving at 500 revolutions per minute.

Separators with a capacity up to 60 gallons per hour are usually driven by hand, while those of greater capacity are worked by a steam-turbine, or more rarely are belt-driven.

*Economy of Separators.*—The advantages in favour of using a separator over other methods of cream-raising are numerous: (1) The separated milk and cream are obtained in a perfectly fresh condition, and the former is in the best possible condition for calf-rearing. (2) The ripening of the cream can be more perfectly controlled, and thus produces a more uniform quality of butter. (3) Considerable economy of space in the dairy is secured, and also saving of labour; shallow or deep pans taking up a large amount of room and necessitating considerable trouble in skimming. (4) Cream of any consistency can be obtained, a point of considerable importance, where it is to be retailed. (5) Economy of time. (6) The milk is to a large extent cleaned and freed from dirt and all impurities. (7) A more perfect separation of the cream from the milk is effected, and the saving in fact will account for from 10 to 12 per cent increase in the butter yield. For example, if we estimate that 220 lb. of butter per annum is an average yield from one cow when the ordinary plan of cream raising is followed; by the use of a separator the amount would be increased to 242 lb., representing a profit of 26s. per cow per year.

*Points of a Good Machine.*—Separators may be compared to bicycles, inasmuch as if the machine is intended to wear well a reasonable price must be paid for it, and it will be found that the best machines are the cheapest in the end. The following points are, however, essential: (1) The machine must be simple in construction, strong, and easily cleaned. (2) Separation should be effected efficiently in the shortest possible time, and not more than 1 per cent of butter fat at the most should be left in the separated milk. (3) As women are frequently called upon to work separators, the driving power required must be as low as possible. (4) The bowl of the machine should be self-balancing, as this is necessary if the best results are to be obtained. (5) The internal fittings of the bowl (which are provided for the purpose of dividing the milk into thin layers so that the centrifugal force may act upon it more quickly) must be of as simple a character as possible, and easily fixed or removed for cleaning.

*Conditions affecting Separation.*—In the first place the speed of the bowl must be sufficiently high, or separation will be incomplete; while the slower the milk is passed through, the more effectual is the centrifugal force to which it is subjected. It is essential that the milk should be at a suitable temperature to obtain the best results, and it is found that the cleanest skimming, with the least loss of fat, is effected when the temperature is from 120° to 130° F. If a minimum temperature of 90° F. can be maintained this will produce efficient separation. Before commencing to separate, care should be taken to see that all parts have been put together in their proper order, and all bearings are well oiled. The bowl should then be flushed out with a quart or so of warm water in order to prevent excessive vibration while the speed is being got up, and the undue chilling of the milk on entering the bowl. Speed must be got up gradually and maintained uniformly throughout separation at the stated number of revolutions per minute. After separation, the bowl should be flushed out with separated milk or warm water in order to force out any cream adhering to it, and also to facilitate subsequent washing. All parts of the separator should be washed, first with warm water to remove all grease, etc., and then thoroughly scalded and dried.

In working a separator the instructions accompanying the machine should be carefully studied, and it is most important that the machine should be firm and perfectly level, which is usually accomplished by letting it into a stone, and this should if possible be entrusted to practical workmen.

*The Auto-Separator* is a self-acting separator recently devised by Mr. G. H. Strawson, which depends for its working on the force of gravity instead of centrifugal action. Cream globules average about  $\frac{1}{1000}$  inch in diameter, and are about 10 per cent lighter in specific gravity than milk, and the cream was formerly obtained by setting milk in shallow pans as already described. The globules of cream at the bottom of a pan 3 inches deep must travel 6,000 times their own diameter to reach the surface, and they have only their difference in specific gravity to force them through the milk, which requires a period of up to thirty-six hours' continuous working. In the auto-separator, on the other hand, these cream globules are only given one-fiftieth of an inch to travel, the fresh milk flowing from an incline as a thin film, and thus they have only 40 times their diameter to travel instead of 6,000, which enormously increases the rate of separation. Moreover, the action is accelerated by the fact that the film of milk is in motion, and thus assists in freeing the fat globules. In practice the fresh milk is fed by a tap on to a flat surface, slightly inclined, over which it spreads evenly and flows towards a little lake below. After a short time the cream globules may be seen gathering on the top of the milk, and although the depth of the stream is here only one-fiftieth of an inch it actually consists of two layers of liquid. The bed of the stream then goes down below the surface of the lake, so that the surface of the stream and the surface of the lake are at slightly different angles. When the stream enters the lake it becomes deeper and slower in proportion, and the thickness of the films of cream and milk increases. The lake deepens

into a little well 1 or 2 inches in depth, and the liquid over this is still in two layers, the cream at the top being about one-eighth of an inch in thickness and the milk about seven-eighths. The milk and cream then flow over two little spouts both nearly at the same level. The cream is taken off by one spout from the surface of the lake, but the separated milk has a shield before the other spout, compelling it to take its feed from the bottom of the well, and this effects efficient separation between the milk and cream.

The machine is made all in one piece, and possessing no mechanical parts is extremely simple and labourless, but the only real criterion of its capabilities will be the result of practical trials.

In order to ascertain the actual percentage of butter fat in cream, provided the fat percentage of the milk is known, and the percentage of the cream taken off, the following formula is generally used, and which allows for a maximum loss of .1 per cent of fat in the separated milk :—

$$\text{Percentage of fat in cream} = \frac{(\text{Percentage of fat in milk} - .1 \text{ loss in separating}) \times 100}{\text{Percentage of cream taken off}}$$

If the percentage of butter fat in both the milk and cream be known the percentage of cream taken off from the milk by the separator may be ascertained as follows :—

$$\text{Percentage of cream taken off} = \frac{(\text{Percentage of fat in milk} - \text{loss in separating}) \times 100}{\text{Percentage of fat in cream}}$$

**Butter-making.**—In order to be able to produce good butter it is necessary that every possible care is taken to keep the milk clean from the time it leaves the cows until it is separated, similar attention being paid to the cream, until it is placed in the churn; as should either the milk or cream come in contact with an impure atmosphere the flavour of the butter will most assuredly become affected, taints or the degree of rancidity increasing the longer it is kept.

The quality or good flavour in butter is dependent upon many conditions, as, for example, the breed of cow, its health, and the manner in which it has been fed, some foods, like crushed oats, imparting an agreeable flavour, while an excess of most oily foods, such as linseed, accounts for the butter having a peculiar oily or tallowy taste; decorticated cotton cake tends to make butter firm, while some foods, as, for example, linseed cake, have a softening effect.

Green foods, like cabbage and more especially swedes, especially when the necks are not removed, and rotten turnips, impart what is known as a "rooty" flavour. Thus, it is evident that when butter possesses some distasteful flavour there must be some direct cause, and the sooner this is remedied the better. This can generally be accomplished by giving careful attention to feeding, and in the treatment of the milk, and the ripening of the cream.

**Utensils and Water Supply.**—In order to make good butter it is necessary to have an adequate supply of hot and cold water, both of

which must be from a perfectly pure source. A churn is the next essential (Fig. 227) and in the selection of this it is preferable to have one in which the lid is fitted with lever fastenings rather than a number of screws to keep it in position. The make recommended is an end-over-end churn. It should be made of hard wood, and

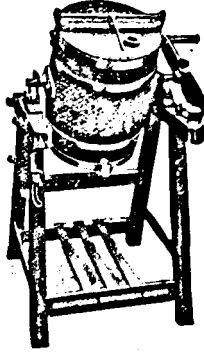

FIG. 227.—"End-over-End" Butter Churn.

must be sufficiently large to prevent its being over-filled, as when this is the case the proper concussion of the fat globules in the cream is hindered.

Other utensils consist of a butter-worker (Fig. 228), scotch hands, sieve, scoop, butter-board, thermometers (Fig. 229), pails (a white

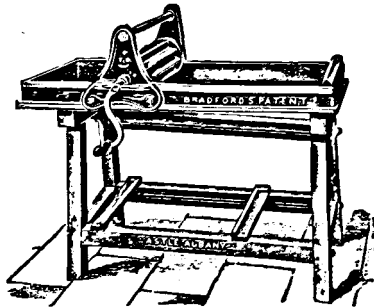

FIG. 228.—Butter-worker.

enamelled one being specially reserved for cream), a cream squeegee, butter muslin, straining cloth, etc. These and other additional accessories, together with their current prices, can be found in the catalogues of those firms which specialize in the manufacture of dairy utensils.

*Treatment of Cream.*—As each lot, or meal, of milk is skimmed from pans, or separated by machine, the cream should be placed in an earthenware crock, stirred, and covered over with a clean piece of butter muslin, and placed in a pure atmosphere at a temperature of about 65° F. in summer, and at not less than 60° F. in winter, to ripen, meanwhile being stirred at intervals during the day. If possible it is always advisable to churn at least twice a week, even although the quantity of cream may necessarily be small, as if churning is only performed once a week there is in summer a risk of its becoming over-ripe and producing sour-flavoured butter, while if kept at a low temperature for too long a period in winter bitter flavours are often developed. In skimming cream from shallow pans it is often difficult to avoid the incorporation of a quantity of milk with the cream, with the result that this settles at the bottom of the cream crock, where it rapidly becomes sour, and is then mixed with the cream at each stirring, where it produces undesirable flavours or rancidity, which is afterwards transmitted to the butter.

Before churning, the consistency of the cream must be carefully regulated so that it will just run freely off a plain wooden hand, and this is best effected by the addition of water of such a temperature that the cream is brought to the proper degree for churning when sufficiently thin. Churning should be performed at a temperature of from 50° to 56° F. in summer and from 58° to 65° F. in winter, or a good rule is to take 56° F. as a standard temperature, and to raise or lower the temperature of churning 1° F. for every 2° F. fall or rise in the temperature of the atmosphere. The temperature of the cream, and also of the churn, must both be the same when churning commences, or must be regulated so that the cream should remain at the correct churning temperature when in the churn.

*Treatment of Utensils.*—Those who have watched butter-making competitions at the principal dairy and agricultural shows must have observed the amount of care taken in the preparation of utensils before the actual process of churning begins. The churn and all utensils should first be rinsed with cold water, after which give a thorough scalding with hot water, with the exception of the churn in hot weather. Finally, rinse with cold water, or brine, placing the smaller utensils on the butter-worker in cold water, and covering the roller and board with damp butter muslin until required. After the butter has been made up, the churn and other utensils must be first washed with warm water to remove grease, and then thoroughly scalded inside with hot water, taking care to ventilate freely to allow the steam to escape. All metal fittings must be carefully attended to, as if left splashed with brine they will very soon become rusty. All muslin

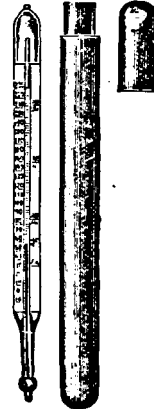

FIG. 229.—Dairy Thermometer.



and straining cloths must be carefully washed and hung up in the open to dry.

*Churning.*—The cream should be strained into the churn through a straining cloth in order to remove all lumps, and in no case must the churn be filled more than half full. Begin by churning slowly, ventilate freely at first, and note that the cream falls from one end of the churn to the other at each revolution, and gradually increase the speed to the number of revolutions recommended by the maker of the churn, usually about 50 revolutions per minute.

The student will soon become familiar with the different sounds of the falling cream within the churn due to the alteration in its consistency. Stop churning as soon as the butter commences to collect, as indicated by the clearing of the glass window in the churn lid. At this stage take the temperature of the cream, and add about a quart of "breaking" water, in order to reduce the temperature to that at which churning was commenced, to facilitate the removal of the butter-milk, and to harden the grains of butter. Replace the lid, ventilate, and continue churning slowly until the butter granules are about the size of small wheat grains, or mustard seed, some butter-makers preferring the grain even smaller. Now remove the lid and draw off the butter-milk, allowing it to pass through the sieve over which a fine butter muslin has been tied, to arrest any grains of butter escaping with the butter-milk. Insert the plug firmly, and wash the butter thoroughly by giving the churn a few brisk turnings, having first added sufficient water to admit of the grains being well floated and washed free from buttermilk; the temperature of the washing water must be regulated inversely to that of the dairy.

*Salting.*—The next process is that of salting, and this may be performed either by placing brine in the churn or by adding dry salt when the butter is on the worker. The brine should be composed of about 1 or 2 lb. of salt, dissolved in each gallon of water, while if dry-salted  $\frac{1}{4}$  to  $\frac{1}{2}$  oz. of salt may be used for each pound of butter, and in the latter process it is most essential to allow the salt time to dissolve before finally working and making up.

By brining the butter over-salting is impossible, as the butter only absorbs a maximum quantity of about  $\frac{1}{4}$  oz. per lb. by this method, so that if additional salt is required this must be added in the dry state. Allow the brine, which must also be regarded in the light of a washing water, to remain in the churn for from fifteen to twenty minutes, or even longer in hot weather in order to thoroughly harden the grains. Do not draw off the brine until all the butter has been removed to the worker.

*Working and Making up.*—Practical experience alone can guide the student in the manipulation of the butter-worker, and in making up the butter into pounds or half-pounds as the case may be. The butter grains must be rolled together very carefully, such pressure only being applied, that in excluding the moisture the texture or grain of the butter is not destroyed by working and rubbing it into a putty-like mass, which when broken open does not exhibit a nice fracture with that clearly defined granular appearance characteristic of carefully made butter. Sufficient rollings on the worker must be given

to rid the butter of all superfluous moisture, as according to law the moisture content of butter in Great Britain must not exceed 16 per cent ; or 20 per cent in the case of Irish butter.

In making up the butter the scotch hands should be used, and the butter firmly consolidated and pressed into straight-edged bricks with firm sharp blows of the scotch hands, taking care to keep the sides parallel and the bricks uniform in size. The butter should then be weighed, wrapped in dry grease-proof paper of good quality, and preferably packed in small chip- or card-boxes. The careful packing and marketing of the finished produce are of no small importance, and if the butter is neatly made up this will always enhance its market value.

## CHAPTER II.

### HARD CHEESE-MAKING.

CHEESE-MAKING is the art of converting the valuable constituents of milk into a state of preservation, fit for future consumption. A large amount of the liquid portion of the milk, commonly known as whey, is expelled, removing with it practically the whole of the milk-sugar; thus, by the removal of a fermentable agency (*lactose*) too rapid decomposition is hindered.

The casein and the residuum of lactose furnish a field for bacterial action. Certain complex changes are thus engendered which, if the desirable ferments are present under suitable conditions, result in the proper and correct ripening of the cheese.

All who wish to master the art and principles of cheese-making must learn to control the ferments or agents responsible for these complex changes, for they may be either friends or enemies. If under proper control, they bring about the desired degree of acidity during the process, and later assist in the due and proper ripening of the cheese; if not properly managed they are a serious menace.

When weather conditions are in favour of an abundant flow of milk, the cheese-maker's prospects are, as a rule, favourable—provided good prices are maintained. It is difficult to surmise the precise tendency of our extremely variable climate, for even when signs are not lacking of a plentiful supply of grass there is always the danger of drought appearing when least expected. And in a dry season it is better to find a ready market for milk than to make it into cheese. Cheese-making is only profitable when the article produced is of first-class quality. It is an art that defies any but the most careful and attentive practitioners to gain substantial profits.

Average quality milk, with a butter-fat percentage of 3.5, is the most economical to use. Some cheese-makers, however, rob the milk of a little of the cream for the sake of a petty and often imaginary gain. With suitable milk, 1 to 1½ lb. of good cheese can be produced from each gallon. This, on the average, realizes from 6*d.* to 7*d.* per lb. wholesale. When retailed, good Stilton and Wensleydale cheeses command from 1*s.* to 1*s.* 3*d.* and good "fat" Cheddars 8*d.* to 9*d.* per lb.

English-made Cheddar is undoubtedly one of the finest types of cheese known in the world, and reasonably good Cheddar can be produced on almost any farm. In Cheshire, Shropshire, Staffordshire, and North Wales, Cheshire cheese-making predominates. It is manufactured in three varieties—early ripening, medium, and late

ripening. The second named is perhaps the most esteemed. It returns a good profit to the maker, being placed on the market at an early date, especially in the large industrial centres.

In the West of England, Wilts, and Dorset in particular, and also in Scotland, the Cheddar process is more in vogue. Of other distinctive varieties of hard-pressed cheese there are : Derby, Leicester, Lancashire, Gloucester, Dunlop, Caerphilly, and Wiltshire "Truckles", also the Smallholder, or Kingston cheese. The varieties of soft cheeses made in this country are mostly of foreign origin, with the exception of Cream, Bath, Slipcote, and Cambridge or York. These latter varieties are the most familiar to cheese-makers in this country. Among other soft or fancy cheeses, more or less extensively made in this country are Camembert, Coulommier, Gervais, Bondon, Pont l'Evêque, Colwick, and Little Wensleydale. The Wensleydale is a blue-veined cheese, equal if not better in some respects to the famed Stilton. It is made in some parts of Yorkshire, and may be compared with the finest type of Gorgonzola ; at all events, its quality is such that it should surely supplant the third-rate Gorgonzolas that are an inevitable item on nearly every restaurant menu. The Dorset or Blue Vinny is also a very popular blue-veined cheese.

**The Milk Supply.**—There are several matters which have created great changes in agriculture and dairying of late. The conversion of tillage into pasture, the use of artificial fertilizers, new and improved systems of farming and drainage, and modern inventions and appliances have all contributed to these changes.

The rich pastures of Somerset and one or two adjacent counties are still renowned as cheese-making centres, and in Cheshire, Leicester, Derbyshire, Gloucester, Dorset, and parts of Shropshire some of the best natural pastures in England are to be found.

Alluvial, marly, or loamy soils are naturally adapted to dairying, and a mild, humid climate, in which extremes of heat and cold are unknown, is to be preferred. Yet, at the same time, dairying is carried on, more or less successfully, in almost every part of the country, both on cold wet clays, and on light, dry, sandy soils.

**Herbage.**—Where new milk is sold, a mixed system of arable and dairy farming on good medium soils and average-sized farms is to be recommended. Pasture is, of course, the most valuable asset on any dairy farm, but in order to keep up the winter milk one must look further ahead. Fodder crops, such as mangolds, swedes, vetches, maize, cabbages, kohlrabi, etc., are invaluable to the milk-seller. Under modern conditions the same system applies with equal force to the cheese-maker. Milk is a valuable product in the winter months, and the price obtained for it should, under proper management, yield a fair margin of profit, in spite of the extra cost of concentrated feeding-stuffs. The cheese-maker, however, depends on pasture grass to furnish the entire needs of his cows in summer.

In Melton Mowbray, which is the Mecca of the Stilton cheese-maker, or even in Ayrshire, no attempt is made to commence operations until the arrival of milk from grass-fed cows. The Cheddar makers are not so particular ; their season commencing as

soon as the supply of milk is good, and irrespective of the food of the cows.

The character of the herbage of grass lands has an undeniable influence on milk production, and butter and cheese are alike affected. Of most practical importance to the cheese-maker is the character of the plants composing the herbage of his grass lands. Good drainage and clean cultivation encourage the finer and more nutritious grasses and plants, and the use of potassic and phosphatic fertilizers tends to improve their quality.

**Poisonous and Injurious Plants.**—Cheese-makers—no less than butter-makers—should be aware of the nature and effects of those poisonous and injurious herbs and plants which impart undesirable taints or flavours to milk, butter, and cheese. The student of dairying will do well to make a collection of these plants, dry them between sheets of coarse brown paper, press them, and mount each specimen on a clean sheet of paper. Appended will be found a table giving the various plants which may be included in this category. Pepper saxifrage is responsible for frothy cream, while butterwort causes “stringy” or “ropy” milk. Peppermint is a very pungent species of mint, and interferes with and sometimes prevents the action of rennet in milk. Monkshood is one of the most virulent of all poisons, and cows partaking of its leaves have been known to die; it is fortunately not so common as it was some twenty years ago. The effect of mustard garlic is familiar; it must not be confused with broad-leaved garlic or crow garlic, both of which impart a strong, onion-like flavour to milk.

COMMON NAME.	BOTANICAL NAME.	NATURAL SOIL OR SITUATION.
Broad-leaved Garlic	<i>Allium ursinum</i>	Moist soils.
Butterwort	<i>Pinguicula vulgaris</i>	Marshy places.
Celery-leaved Crowfoot	<i>Ranunculus sceleratus</i>	Meadows.
Common Monkshood	<i>Aconitum Napellus</i>	Hedgerows.
Corn Chamomile	<i>Anthemis arvensis</i>	Cornfields.
Cowbane	<i>Cicuta virosa</i>	Pools and ditches.
Crow Garlic	<i>Allium vineale</i>	Ditches and banks.
Cuckoo Pint	<i>Arum maculatum</i>	Wet pastures.
Fool's Parsley	<i>Æthusa cynapium</i>	Pastures, roadsides.
Garlic Mustard	<i>Sisymbrium alliaria</i>	Roadsides.
Hawkweed	<i>Hieracium Pilosella</i>	Dry soils.
Hemlock	<i>Conium maculatum</i>	Ditches.
Ivy	<i>Hedera Helix</i>	Hedges and on trees.
Pasque Flower	<i>Anemone Pulsatilla</i>	Chalky pastures.
Pepper Saxifrage	<i>Silau pratensis</i>	Meadows.
Peppermint	<i>Mentha piperita</i>	Ditches, roadsides.
Stinking Chamomile	<i>Anthemis Cotula</i>	Ditches, waste land.
Tansy	<i>Tanacetum vulgare</i>	Waste places.
Wild Chamomile	<i>Matricaria chamomilla</i>	Waste places.
Wild Radish	<i>Raphanus Raphanistrum</i>	Waste ground.
Woody Nightshade	<i>Solanum dulcamara</i>	Hedgerows.
Wormwood	<i>Artemisia Absinthium</i>	River banks.
Yew	<i>Taxus baccata</i>	Any soil, in hedges or as trees.

## THE CHEESE-MAKING DAIRY.

Dairies may be constructed for any particular purpose—milk-selling, butter-making, or cheese-making. Model dairies are not always well adapted for the purpose for which they were built, and are therefore often impracticable. A cheese-making dairy must consist of at least four separate compartments:—

1. The making-room, containing nothing but the milk and curd, and the appliances necessary for their manipulation.
2. The press-room.
3. The hot-water room and washing-up house.
4. The curing-room.

In large dairies there is also a whey-room, but in a small dairy the whey is usually taken away directly it is drawn, and utilized for feeding pigs. The curing or cheese-ripening room may be over the dairy and boiler-house, and approached from the latter by means of a wide staircase, or connected by means of a lift; this plan is usually adopted where the building is of such a height as to correspond with the dwelling-house. The cheeses keep well for a few weeks in the ripening-room above the press-room, but if they are to be held for a long time they should be removed to a cooler room.

**Situation and Aspect.**—A well-equipped dairy should occupy an open, healthy site, as far removed as possible from the piggeries, cattle sheds, yards, stables, etc. If attached to a dwelling-house it should be on the north side; or, if the house faces south-east, the aspect of the dairy should be north-west, so that the sun may cross it during the day. If butter-making is to be included as part of the business, this situation is the best that can be adopted, for a south frontage is unsuitable in such a case. Strong sunshine is apt to exert a harmful effect upon milk and curd; hence it is advisable to shelter the south windows with a verandah roof.

Other points to be borne in mind in planning a cheese-making dairy are convenience and economy, the control of temperature, the soakage of surface water, the water supply, and the drainage system. It may be further remarked that where the stock number from fifty to sixty head of cows a ground area of about 27 by 18 feet is required, the height being not less than 12 feet. A hollow brick wall is to be preferred, and glazed windows should be inserted on the north, south, and east sides. Each window should be fitted with a sliding casement, and protected on the outside by finely perforated gauze. The floor is best made of hard brick or encaustic tiles with a smooth surface, tilting slightly towards the gutters.

**Drainage.**—The drainage from cheese-making dairies should receive special attention. It contains the washings of cheese-cloths and appliances, and is greasy, caseous, acid, and ready for quick decay or putrefaction. It must not be discharged anywhere near the dairy or dwelling-house, but should be led through the walls of the dairy by means of well-trapped drains outside, into a cesspool some distance away. No closed or other drains from the outside should have access to the dairy; inside, the best material is to be found in shallow glazed channels or cemented open drains. Perhaps

the best means of dealing with the sewage from a cheese-making dairy is to collect it daily in a small tank, where the suspended impurities may be chemically precipitated by means of ferrous sulphate or some other cheap chemical.

**Heat, Light, and Ventilation.**—These are three important factors in a cheese-making dairy. Lack of warmth in spring and autumn often interferes with the manufacture, and the loss so incurred would be more than covered by the installation of hot-water pipes, radiator, or a slow-combustion stove. The curing-room is best heated with hot-water pipes, laid close to the walls, and, to preserve an even temperature, the roof joints should be boarded and covered with felt, the roofing being composed of tiles in preference to slates. Abundance of light is essential, and ventilators should be placed both below and above to permit the air to circulate properly.

**The Boiler-house.**—In an ordinary sized dairy the boiler-house should have a ground area of 21 by 15 feet; and if detached from the dairy, or abutting on to it, the floor and windows should be in keeping with those of the latter building. For general purposes,

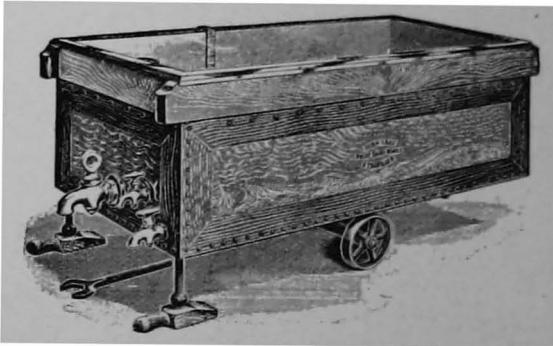

FIG. 230.—Cheddar Cheese Vat.

a small saddle-boiler with the necessary supply of hot-water tanks and other appliances, including a pump for drawing water from the well and keeping the boiler supplied, prove very effective. It presents few difficulties in management, and is also economical as regards fuel. Further, in such an installation, cold and hot-water taps can easily be fixed in all parts of the dairy, and also in the dwelling-house if desired.

**Appliances.**—The complete equipment of a cheese-making dairy is a somewhat costly matter, for the utensils required are very numerous. Space will, however, only admit of a reference to those of the most importance.

**Milk Vats or Cheese Tubs.**—Several new and improved types of cheese vats have recently been placed on the market, and they can be obtained in all sizes from 40 to 400 gallons capacity. A good cheese vat (Fig. 230) should consist of an inner case made of tinned steel, and an outer one of iron, painted and grained, and fitted with pipes for a steam connexion. It must also be fitted with a whey plug,

water cock, and whey filter. Supposing the number of cows varies from thirty to thirty-five or forty, the maximum capacity required will be 150 gallons; and an up-to-date cheese vat of this size will cost something like £15 10s.

*Curd Mill.*—A Cheshire pattern curd mill should admit of taking to pieces easily, so that the parts can be cleansed without difficulty. A well-known type of curd mill is fitted with two spiked rollers, working up to a spiked breast. The hopper is best made of block tin, and the mill is mounted on a cast-iron stand, there being sufficient space underneath for a large pan to receive the broken curd. A mill can also be obtained adapted for fixing to the cheese vat or tub.

*Presses.*—Improved types of lever presses (Fig. 231) are obtainable in all sizes and at all prices. A patent compound lever is fitted to most up-to-date types, and the legs are furnished with rollers to

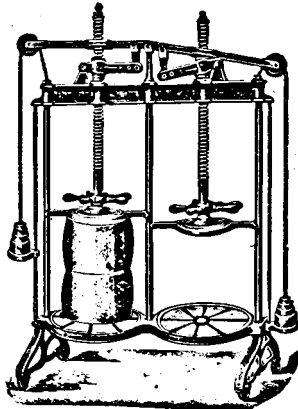

FIG. 231.—Double Chamber Hard Cheese Press.

facilitate movement in the dairy. Modern levers are a vast improvement on the old stone presses.

*Hoops.*—Wooden hoops for Cheddar-shaped cheeses should be made of well-seasoned oak with wrought-iron bands; they are made in various sizes, from 8 to 10 lb. capacity, costing from 8s. 6d. to 22s. each. Tinned steel hoops (Fig. 232) are preferred to wooden ones by some, as they are more easily cleaned, lighter to handle, and the cheese is more readily removed than from the wooden hoops.

*Miscellaneous Appliances.*—In addition to the above, the utensils required in Cheddar cheese-making and other systems include the ordinary milk-pails, coolers, shallow pans, milk and curd strainers, curd shovels, tin whey syphons, curd breakers, cheese stools, brushes, tasters, curd cooler with draining racks, salt scales, weighing machine, thermometers, testing iron, dippers, measuring glasses, draining and cheese cloths, and acidimeter.



**Treatment of the Milk.**—Milk must be clean and free from taint in order to make the finest quality cheese. Ayrshire milk is perhaps best suited to cheese-making, although the majority of makers in this country use the milk of the Shorthorn. The following are some important points which should be observed closely by every cheese-maker:—

1. Milk which has been produced in badly ventilated stables or carried in dirty pails becomes tainted, and for this reason the cheese made from such must be allowed to attain a greater degree of ripeness before vatting.

2. Milk tainted with undesirable bacterial ferments will produce cheese of inferior flavour.

3. Milk yielded by cows that have been fed on clover and aftermath will result in "heaving" cheese.

4. Acid preservatives must never be used in milk intended for cheese-making.

5. Milk that is rapidly cooled immediately after milking to a temperature of, say 55° F., will keep sweet twice as long as ordinary cooled milk.



FIG. 232.—Cheddar or Cheshire Cheese Hoop.

6. Acidity in milk is caused by lactic acid producing bacteria, which convert the milk-sugar (lactose) into lactic acid.

7. If the evening's milk is not cooled properly it will become excessively sour or acid by the morning. The temperature to which the evening's milk should be cooled is about 70° F. in spring and autumn, and a few degrees lower in the summer.

8. Cooling prevents the growth of many bacteria, and the degree to which cheese-making milk is usually cooled on the farm is most suitable for the right kind of lactic acid producers.

9. Large quantities of milk must be cooled to a lower temperature than small quantities, as they retain heat longer, and gather acidity quicker.

10. Where the home milk is supplemented with purchased milk, it is advisable to cool the latter, and, after mixing it with the morning's milk, the contents of the vat should be inoculated with a pure culture of lactic acid.

11. In order to keep the contents of the vat free from dust and dirt, it should be covered with a muslin cloth during the night.

12. The cream that has risen during the night must be skimmed off, heated to 100° F., and then stirred in with the morning's milk.

13. A special dairy "float" thermometer should be used in order to determine the temperature.

**Ripening the Milk.**—Ripeness in milk is really a stage of fermentation, and this must attain to a certain degree before the milk can be considered ripe or ready for renneting. For the hard-pressed varieties of cheese an acidity of from 0.20 to 0.22 per cent is desirable. Many cheese-makers have trained and sharpened their senses of taste and smell to such a pitch that they can tell, with a very fair degree of accuracy, the amount of lactic acid present in the milk. This may prove a fairly reliable guide for old and experienced hands; but for young and inexperienced cheese-makers there are safer and more reliable tests in the shape of acidimeters, etc.

**The Importance of Acidity.**—A knowledge of the acid contents of milk intended for cheese-making is most desirable, for the proper and safe control of the different ferments cannot be gained unless this exact knowledge is acquired. Perhaps the most practical form of

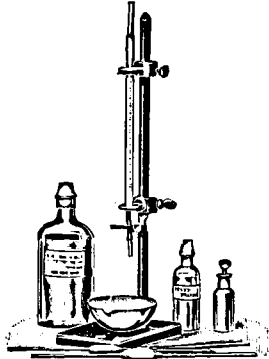

FIG. 233.—Dairy Acidimeter.

acid test is the dairy acidimeter (Fig. 233). The main principle upon which the working of an acidimeter is based is that it takes a certain amount of caustic soda to neutralize a certain amount of lactic acid; and an indicator known as phenol phthalein is required in order to show when this neutralization has taken place.

**Materials and Apparatus.**—The alkaline solution is prepared by dissolving 4.5 grams of 98 per cent pure caustic soda in a litre of distilled water; unless one has a knowledge of analytical chemistry, it is preferable to obtain a properly prepared solution from a chemist. This should be of such strength that 1 cubic centimetre of it will exactly neutralize 0.01 gram of lactic acid. The apparatus required consists of a burette and stand, pipettes, porcelain basin, drop bottle for indicator, and stirring rods. The whole set can be obtained, together with one litre of standard caustic soda solution and 150 c.c. of phenol phthalein, at a cost of 15s. 6d.

**Example of a Test.**—The method of using the acidimeter can perhaps be best explained by giving an example of its use; 10 c.c. of the sample to be tested are carefully measured out by means of the pipette, and then placed in the porcelain dish. Three or four drops of phenol phthalein are then added. A quantity of caustic soda solution is placed in the burette, the reading being, say (for the purpose of our example), 15 c.c. It is then allowed to fall, drop by drop, into the milk, stirring the contents of the porcelain dish in the meantime. Presently a faint pinkish tinge will become visible, and as soon as this happens no more caustic soda solution must be allowed to mingle with the milk. The reading of the burette is then taken, say 17.2 c.c., from which it is concluded that 2.2 c.c. of alkaline solution have been required to neutralize the acid contents of the milk. Therefore, if 2.2 c.c. neutralize 10 c.c. of sample, and 1 c.c. neutralizes 0.01 gram of lactic acid, 2.2 c.c. will neutralize 0.01 by 2.2 grams = 0.022; and if there is 0.022 grams of lactic acid in the sample (10 c.c.) of milk, there will be 0.22 grams in 100 c.c. Thus the acidity of the milk is reckoned at 0.22 per cent. As a rule, taking the Cheddar system as an example, the average acidity of the milk on starting is 0.23 per cent; that of the whey, on cutting the curd, is 0.14 to 0.15 per cent; when the whey is drawn it is 0.19 per cent; in the curd, at the grinding stage, it is 0.8 per cent; and when ready for the press, 0.9 to 1.0 per cent.

**Rennet Tests for Acidity.**—The percentage of lactic acid in milk can also be readily determined by the means of a rennet test. A simple method of testing is as follows:—take 4 oz. of milk and 1 drachm or  $3\frac{1}{2}$  c.c. of rennet, and bring both to a temperature of 84° F. Place the rennet in a cup, together with three or four short lengths of straw as indicators. When the temperature is at the required degree, pour the milk into the rennet cup, and commence stirring at once with the thermometer. Continue this stirring for 15 seconds and remove the thermometer: the latter should then read 84° F. When the straws stop moving and become suddenly stationary, make a note of the number of seconds that have elapsed since the rennet first came into contact with the milk to the moment at which the straws ceased moving. The number of seconds indicate the rennet test, and give some idea of the rate at which acidity is progressing.

The Marshall test is another simple means of ascertaining the acidity of milk. The chemicals used are very cheap, and the whole apparatus, together with a supply of materials requisite for about 1,000 tests of milk, can be obtained for about 10s., with full instructions for use.

**Wisconsin Curd Test.**—This is a very useful mode of testing the general quality of the milk intended for cheese-making. Wide-mouthed glass jars, fitted with tin caps, are necessary, into each of which about a pint of the different samples of milk to be tested should be placed. The jars are then immersed in hot water in a tub, and the milk brought to a temperature of 98° F. Ten drops of rennet are next added to each jar and thoroughly mixed with the contents. Presently, the milk will coagulate, and as soon as the curd becomes

fairly firm it is cut into small pieces. The whey is poured off as fast as it separates from the curd, the latter being kept in a temperature of 98° F., for eight or nine hours. At the end of this time it is examined, and, if firm and solid, the milk from which it was obtained may be depended upon as being good and clean, and well fitted for cheese-making. If it is honeycombed with small holes, the milk may be put down as tainted with undesirable bacteria; it would in all probability give rise to serious trouble in the process of making the cheese. In this manner bad milk can be detected, and its degree of fermentation indicated.

**The Use of Starters.**—In all hard-pressed cheese-making systems it is a wise plan to make use of a starter for ripening the milk. Many successful makers agree that the use of a starter, or pure culture of lactic acid in a quantity of milk, not only hastens the ripening of that milk, but the flavour of the cheese will depend somewhat on the flavour of the culture used. Starters are of three kinds: (1) simple, natural, ripening, controlled principally by the

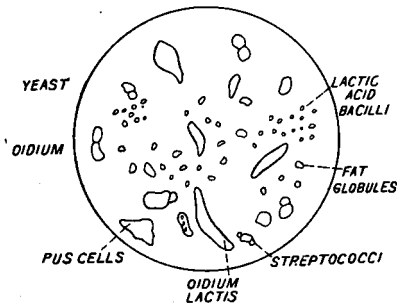

FIG. 234.—Drop of Sour Buttermilk magnified.

temperature; (2) naturally ripened agents, such as sour whey, buttermilk (Fig. 234), or ripened milk; and (3) pure cultures of lactic acid and desirable bacteria.

**Natural Starters.**—Sour whey, held over from a previous day's making, was at one time one of the commonest forms of starter, or "kindler". The disadvantage of using this medium, however, is that in the event of the whey having acquired a strong, disagreeable odour, this defect will be transmitted to the cheese manufactured from it. Sometimes whey starters are obtained from other sources, where the cheese is known to be turning out satisfactorily; but rarely can they be depended upon to give the best results. Pure-culture starters are much preferable. With the natural ripening process there is much uncertainty as to the nature and extent of the fermentations which have been set up in the milk overnight.

**Pure-culture Starters.**—These are produced by cultivating the desired bacterial organisms in a suitable medium, and propagating

them from day to day in Pasteurized separated milk. It is well recognized that the quality of the cheese is more uniform when a pure-culture starter is used than when the natural ripening process or even home-made starters are employed. Many of the leading makers of Cheddar cheese have adopted this system, and it is being widely extended, both in the manufacture of butter and cheese, through the educational methods practised at all the dairying institutions and colleges throughout the country. These institutions, by the way, furnish the best sources of information as to the uses and advantages of pure-culture starters; and supplies can usually be obtained through them. Not only does this ripening agency assist materially in the souring of milk and in the development of the correct amount of acidity, but it is possible, by its use, to make marketable cheese from bacterially-contaminated milk, which otherwise would have produced a tainted, valueless article.

**Heating the Milk.**—The coagulation of the casein is brought about by the action of rennet, but before this addition is made the milk must be brought to a suitable temperature. This process is important, but it has been greatly facilitated by the introduction of new and improved types of cheese vats, with the use of live steam as a heating agency. Reference has already been made to jacketed vessels, which permit of the inner vat being surrounded by water, into which live steam can be driven. The milk can be heated to a more exact degree by their use than by the old-fashioned system, and there is less danger of over-heating. In a steam-jacketed vessel of this kind care should be taken to turn off the steam when the temperature of the milk is several degrees below the renneting temperature; and the milk should be kept thoroughly well stirred in the meantime.

The rate at which the temperature of the water is raised will determine the stage at which the steam is turned off. The slower the rate of heating, the nearer may the temperature of the water approach to that of renneting. Over-heating will prevent the proper action of rennet, for an excessive temperature will change its character, and the lime salts in the milk, which react with the rennet, will be rendered partly abortive or insoluble. If steam-jacketed vessels are not used, and the temperature is simply raised and regulated by heating small portions of the milk and returning them to the bulk so as to bring the latter to a uniform temperature, care must be taken not to heat any portion over, say, 120° F. It is preferable to heat several small quantities of milk to this temperature than to heat one portion to an excessive degree.

Supposing, for example, 40 gallons of milk, at a temperature of 75° F., are to be raised to a temperature of 85° F., it will be necessary to know to what temperature a portion of this 40 gallons—let us say 10 gallons—must be raised so as to produce this result in bulk. The required temperature may be arrived at by multiplying the total number of gallons of milk (40) by the number of degrees rise in temperature required (10), and dividing the result (400) by the number of gallons of milk to be heated (10); 400 divided by 10 gives 40, and this, added to the original temperature of the milk, gives 115°. The requisite temperature to which the 10 gallons must

be heated with therefore is 115° F. It is usual to take out about one-sixth of the quantity for this purpose.

**Rennet.**—Rennet, which is a necessary ingredient in ordinary cheese-making, can be obtained in powder, liquid, and tablet form. It is used for the purpose of coagulating the milk, one of the enzymes of the extract, rennin, precipitating the casein in the form of a clot. The greater the acidity of the milk the quicker is the action of rennet; hence the first direct effect of acidity is to assist the rennet's action, while the soluble lime salts assist the action of this coagulating medium. Formerly, the rennet used was generally home-made, and even to-day some cheese-makers prefer this; in such cases the best quality of rennet is obtained from the stomachs of newly-born calves, and may be purchased in the form of dried vells at a cost of about 7s. per dozen. These vells are cut into strips, soaked in strong brine for four or five days, and the liquid is then strained off. Many reliable Rennets can, however, be purchased in liquid form from manufacturers, and their use is now almost universal among makers of hard-pressed cheese.

Rennet powder should be white, and easily soluble in water, without any traces of disagreeable odour. It should be uniform in strength, so that the quantity necessary for curdling a certain amount of milk can always be calculated to a nicety. Makers of good rennet powder consider that it will keep in any climate for any length of time. It is sold in tins containing 1 lb. at a cost of 10s. Each teaspoonful of rennet powder must be thoroughly dissolved in 1 oz. of cold water, and sufficient powder for immediate use should be dissolved. Cheese rennet tablets are used in a similar manner to rennet powders, each tablet being sufficient to coagulate 15 gallons of milk. Tubes containing 20 tablets cost 1s.; tins with 100 tablets 4s. each. The use of these tablets does away with weighing and measuring, and there is therefore no trouble in calculating the requisite quantity of rennet. A good brand of rennet extract is most essential. There are several preparations on the market, and they are usually put up in earthenware jars at about 9s. 6d. per gallon, or in casks containing from 1 to 3 cwt. Graduated measuring glasses are necessary for use with liquid extract of rennet. In appearance it should be of a light straw colour, and is best kept in the dark in well-corked stone jars.

**Annatto.**—Annatto is in certain cases used in order to colour cheese. It is a material obtained from the seed pods of a tropical bush, called the *Bixa orellana*. A good extract of annatto should be pure, strong, and perfectly harmless; there should be no sediment, thus permitting it to be used to the last drop, and of course it should be absolutely free from aniline dyes. Annatto is liable to produce irregularities in cheese if not properly mixed with the milk at the right time; similarly, there is the danger which may arise from its fermentation, and in tainted cheese the difficulty of "flying colour" may be encountered. About 2 oz. is usually sufficient to colour 100 gallons of milk for, say, Cheshire cheese, or more may be used if a comparatively deep colour is desired, as in Leicester cheese, when often 1 oz. to 10 gallons is used. Before using, the colouring

matter should be diluted with about six times its own bulk of water. Annatto extract of a good brand costs about 4s. per quart bottle, or 14s. a gallon jar.

**Salt.**—Curd ripened without salt acquires a strongly bitter flavour, but this is neutralized if salt is used in sufficient quantities. Salt also facilitates the expulsion of the whey, and, of course, acts as a preservative. The moisture and acidity of the curd determine to a great extent the required proportion of salt which should be used. In the Cheddar system 1 lb. of salt is usually added to every 50 lb. of curd. Needless to say, a good brand of dairy salt is essential, for impurities introduced into the curd through this medium are detrimental to the cheese, usually giving rise to a certain degree of bitterness, besides checking fermentation. The size of the grains is of some importance, and it is generally held that for such cheese as retain the higher proportions of whey a coarse-grained salt is preferable. For dry curd a finer salt will answer the purpose better.



FIG. 235.—Vertical Curd Knife.



FIG. 236.—Horizontal Curd Knife.

**Treatment of Curd.**—The shrinkage of the curd, and the consequent expulsion of moisture, are brought about by the development of acidity, by the action of heat, the action of rennet, and pressure in presses. The proper and complete control of these factors is of the utmost importance in the manufacture of prime cheese.

The cutting of the curd into fine particles facilitates "cooking" by exposing a greater surface. Experiments have proved that—other conditions being the same—the smaller the curd is cut the less moisture there is when the whey is drawn and when hooped. It is recommended that cheese-makers should possess a set of the different knives (Figs. 235 and 236), from  $\frac{1}{8}$  to  $\frac{3}{4}$  of an inch, so as to be able to use them according to their desire to remove the whey quicker or slower. The golden mean for Cheddar cheese seems to be  $\frac{3}{8}$  to  $\frac{1}{2}$  in. knives, the important point being to leave the proper amount of moisture in the cheese when ready for the consumer. If the acidity is excessive, as in the case of over-ripe milk, normal conditions must be immediately re-established with counteracting agents. This is only

to be achieved by cutting finer, and so getting the moisture properly adjusted in the curd prior to the expulsion of the whey.

When cutting the curd, always aim to make the cubes of uniform size, and follow any course that will help to secure this result. A curd that is allowed to become too firm can never be cut so well and evenly as one which is of the correct consistency, and if the cubes are irregular in size there will be different kinds of curd in the vat when the whey is removed. Similarly, if the curd is not properly firm before the whey is removed it will result in tender-bodied cheese that is described as "acid cut".

A simple test to ascertain when the curd is ready to cut is when it breaks clean over the finger, or over the end of a thermometer passed lightly under the surface.

The cooking of the curd largely determines its subsequent texture and body as cheese, and also the keeping properties of the latter. Various factors will influence the temperature to which the curd should be raised for cooking or "scalding"; and the season of the year, quality of the milk, and food of the cows, will all have their controlling influences. As a rule the temperature varies from 94° to 104° F., but it is a wise plan to avoid raising it above blood heat. Under the action of heat, so applied, the curd dries and shrinks, and this process, in conjunction with the proper development of acidity, gives it that property and consistency whereby the finest quality is developed in the product. It is of prime importance to control the fermentative and draining processes with a double rein, as it were, for the best results are only secured when these are developed together, so that when the curd is just sufficiently dry, the acidity may be just sufficiently developed. If the proper texture in the curd cannot be secured, the heating temperature should be raised, and the same plan may be wisely adopted as the season advances and the milk becomes richer in fat.

Modern curd mills have done away with a great deal of labour and inconvenience associated with the old plan of "crimming" by hand. The object of the process is to reduce the curd to particles of convenient size for receiving the salt, and for pressing it into a solid mass in the cheese-hoop in order to facilitate the expulsion of moisture, and also to cool it.

#### HARD CHEESE-MAKING.

A report issued by the United States Department of Agriculture mentions two hundred different kinds of cheese made in various parts of the world. In England, hard-pressed cheese is made under various systems of manufacture in different counties or districts.

Cheddar is perhaps the best-known type of cheese made in the United Kingdom. It has a close, waxy texture, and should be rich and buttery in flavour, and full, mild, and "nutty". A good Cheddar cheese is close and firm in appearance and may weigh from 70 to 100 lb. It will keep for nine or twelve months, and can be exported without damage. Originally it was made in Cheddar, Somerset, and after half a century or so the practice found its way into Scotland.



A brief description of the method of manufacture, as taught in all the dairying schools in the country, is as follows :—

The evening's milk is cooled to 70° F. and vatted, the cream that rises to the surface being skimmed off in the morning ; this cream is warmed and again mixed in with the contents of the vat, together with the morning's supply of milk. About one-half per cent of starter is then added for large quantities of milk, and from 1½ to 2 per cent for small quantities, and when the milk test shows from 0.20 to 0.22 per cent of acidity, rennet is added at the rate of 1 drachm to every 3 gallons of milk at a temperature of 84° F. Two ounces of colouring matter may be stirred into every 100 gallons of milk at a temperature of 84° F. if thought desirable, but it must not be allowed to come into contact with the rennet before being used. Stir the rennet into the milk thoroughly, and agitate the surface so as to prevent the cream rising. Then cover the vat with a clean cloth and leave the contents to coagulate. In about forty or fifty minutes after renneting the curd should be cut both lengthways and crossways with the vertical knife and once each way with the horizontal knife, while some makers finish the cutting with the fine wire knife after the curd has been cut in "blanket" form. Needless to say, a considerable amount of care must be exercised in cutting the curd, for there may be a very serious loss of fat due to rough handling and untimely cutting.

The acidity of the whey that drains out after cutting the curd should be about 0.15 per cent. Stir and break up the curd continuously for about 1½ hours while it is being "cooked" or scalded, and then allow it to pitch; if, however, there is too much acidity in it do not let it settle at all. Scalding encourages the contraction and hardening of the curd, and so assists in the separation of the whey ; the temperature of the scald must, however, be lower than usual for sweet milk—generally produced on chalky soils—and higher for acid milk, produced from clay land. As soon as the curd becomes springy and the particles do not adhere when pressed in the hand, it should be allowed to pitch for about fifteen minutes. The whey is then drawn off when it shows 0.18 or 0.19 per cent of acidity. When the hot iron is applied to the curd it draws strings no longer than ¼ in.; and after that the mass of pitched curd is cut up into 9 in. squares and piled three deep at the end of the vat or cooler, strainer cloths, previously wrung out in hot whey, being flung over them. In about twenty minutes the curd will have become solid, and after turning the pieces every fifteen minutes or so, it should be milled when the hot iron draws threads 1½ in. long.

The curd should at this stage be in a flaky condition, smooth, compact, and fairly tough ; about 1½ hours usually elapse from the time of removing it from the vat to the time when it is milled. A ripe, creamy flavour will have developed, equal parts of whey and liquid fat separating out on the curd being squeezed in the hand. Salt is then added at the rate of 1 oz. to 3 lb. of curd, the temperature of the latter at this stage being about 70° F. After salting, the curd is packed into moulds lined with coarse cloths, and a small pressure of 2 cwt. applied gradually, the weight being gradually increased until there is 10 cwt. pressure being exerted in about two hours' time.

Turn the cheese in the evening, and leave it under 20 cwt. for the night; then in the morning the cloth is removed and a little lard rubbed on. On the following day the cheese is bound with stout calico and placed in the ripening-room at a temperature of from 58 to 62 degrees.

**Cheshire.**—This variety is made under three different systems, the early ripening, medium, and late ripening. Medium ripening cheese is made from mixed milk heated to 86° F., colouring matter being added at the rate of 1 drachm to 3 gallons of milk. When the rennet test shows 22 to 23 seconds coagulation, rennet is added at the rate of 1 drachm to 3½ gallons of milk, stirring the same into the milk thoroughly for about five minutes. The milk is then allowed to settle for about five or six minutes, and the cream is gently stirred in. In from forty-five to fifty minutes the curd will usually be ready to cut. Cutting in this case must be performed very lightly and quickly, first lengthways and crossways with the vertical knife and next in the same fashion with the horizontal knife, afterwards being gently stirred so as not to bruise the curd.

The scalding temperature is from 92° to 94° F.; the time twenty-five to thirty minutes, and the rate of scalding 1° in four minutes. The curd should be gently stirred whilst it is being cooked, and also for a little while after finishing, and when it feels fairly dry it should be drawn and left to mat at one end of the vat; when it threads ¼ in. on the hot iron, the whey is run off and the curd cut into blocks and placed one against the other at one end of the vat, under a rack and weight. On ½ in. threads being drawn—or when the curd tests at 0.3 per cent of acidity—3 in. cubes should be cut, placed on a rack in the bottom of the vat, and covered with a second rack and weighted, the cubes being subsequently turned every ten minutes until the curd tests to 0.4 per cent of acidity, or ¾ in. threads can be drawn on the hot iron.

At this stage the curd is ground and stirred thoroughly for five minutes. Salt should then be added at the rate of 1 oz. to 3 lb. of curd, and stirred in as thoroughly as possible. The temperature should be from 75° to 80° F. After salting, the curd is filled in to cloth-lined moulds, and placed in a small room where a jet of steam can be turned on—or furnished with a properly constructed Cheshire cheese oven. In the morning a fresh cloth is put on, and a low pressure of 6 or 8 cwt. applied, the cheese being turned in the evening and returned to the press under 10 to 12 cwt. The coarse cloth is removed on the following morning and replaced by a fine one, and the cheese is put back in the press under 20 to 25 cwt. pressure. The next day it is taken out of the press, greased with hot butter or lard, and each end fitted with a "cap", and it is afterwards replaced in the press under 30 cwt. During the day the cheese must be turned again and the caps pressed on as tightly as possible, and in the evening or the following morning it should be tightly bandaged with strong calico 3½ inches wide, and transferred to the ripening-room.

**Derbyshire Cheese.**—This is a close-textured cheese, but not so waxy as Cheddar, and it is moderately soft and mellow, mild in flavour, and white in colour, each cheese weighing about 30 lb. The

morning and evening milk are mixed and brought to a temperature of 84° F., the starter being added at the rate of from  $\frac{1}{4}$  to  $\frac{1}{2}$  per cent, according to the rennet test. In a quarter of an hour's time or so, the milk should again be tested, and when the rennet test indicates a 20 to 23 seconds coagulation, a drachm of rennet, diluted with three or four times its volume of cold water, is stirred gently into every  $3\frac{1}{2}$  gallons of milk for about six minutes.

In about fifty minutes, or as soon as the curd "breaks clean" over the end of the finger, it is usually ready for cutting. This must be done as quickly and as lightly as possible, first lengthways and crossways with the vertical knife, and then lengthways with the horizontal knife, into  $\frac{1}{2}$  in. cubes. It is then stirred, from the bottom and the sides, for about eight or ten minutes, and afterwards scalded to a temperature of 95° at the rate of 1° in  $3\frac{1}{2}$  minutes, stirring gently in the meantime, until the curd becomes firm and the fragments do not contain much moisture when split open. The sides of the vat are then rubbed down with the hand, and the curd allowed to settle. The whey is drawn when  $\frac{1}{2}$  in. threads can be drawn out on the hot iron, and the curd is scooped out of the vat on to a cloth spread over a drainer and gently stirred.

After fifteen minutes, the curd is cut into eight pieces, and turned, so that the pieces are arranged two deep, and these are turned again at the end of a quarter of an hour and arranged four deep; in another fifteen minutes the pieces are once again turned and placed in a single pile. Hot iron tests should be made at intervals in order to ascertain at what rate the acidity is progressing; if this is taking place very quickly, the curd should be turned oftener, neither should it be piled so deeply nor kept so warm. The curd will eventually be ready for grinding when the hot iron draws 1 in. threads.

After grinding and stirring for about ten minutes, 1 oz. of salt is well stirred into every 4 lb. of curd, the latter being at this stage at a temperature of from 74° to 75° F. It is then filled into moulds lined with damp cloths, and put under a very light press for three hours or so, increasing the weight gradually until some 8 cwt. is reached. In the evening of the same day the cheese should be turned into a fresh cloth and put back in the press under 15 cwt., the coarse cloth being removed on the following morning and caps fixed on the ends; afterwards the cheese is returned to the press and put under a weight of 25 cwt. Next day the caps are pasted down, and the cheese bandaged with strong calico. It may then be taken to the ripening-room and kept there at a temperature of 60° F. for four weeks, turning it each day during this time. After about another fortnight, in a fairly damp cellar, the cheese is usually ready for market.

Leicester Cheese.—Flat, coloured, Leicester cheeses are very rarely made or even consumed outside the eastern counties. They are disc-shaped as a rule, measuring from 17 to 21 inches across the top and from 5 to 7 inches deep. A good cheese of this variety is almost as rich as butter, and easily spreads on bread. It is not an easy variety of cheese to make, but the process is briefly as follows:—

The evening and morning milk are mixed, after first skimming the cream from the former, and a pailful of warm milk is poured over

the cream to melt it, the latter being then carefully stirred into the contents of the vat, and the whole is brought to a temperature of from 82° to 86° F., according to the season of the year. Two tablespoonfuls of colouring matter are usually allowed for a large cheese, and a bowl of sour whey is also sometimes added to cause a slight acidity. About an hour after renneting the curd is, as a rule, ready to break with breaker consisting of a stout wire circular rim, covered with strong wire mesh, fixed on the end of a shaft. When all the curd in the vat has been very carefully and slowly broken up into extremely fine pieces, it is covered over with a cloth and left to settle for a few minutes. The whey is then drawn off by means of a strainer of open flax cloth, on which is placed a wooden hoop-rim drainer, with a horsehair-cloth bottom, the whole being pressed very gradually and gently into the curd, the whey being ladled off into a bowl.

After the whey has been completely drained off, the old-fashioned method is to set the curd in a strainer within the vat, and press on the curd with the hands, changing its position several times, so that it eventually becomes dry enough for grinding. Another method is to put the curd into cloths, and weigh it, cutting it in the meantime into cubes about 4 inches square, alternately cutting and pressing until the curd is dry. After this the curd is milled and subsequently filled into the moulds, which are in turn placed in the press.

Lancashire Cheese is very similar to Cheddar, but rather more porous; it is a soft, open, and "meaty" textured cheese, not spongy nor yet crumbly. The evening's milk is strained into the vat overnight, and stirred once or twice to prevent the cream rising to the surface; in some cases it is cooled beforehand to 68° or 75° F., so that by the morning it will be at about 60° to 68° F. The morning's supply is then added, and the whole heated to about 80° F., at which temperature 1 drachm of rennet is added to every 2 or 3 gallons of milk, the rennet having previously been diluted with four times its volume of water. This is stirred into the milk for about three minutes, and coagulation will usually have been completed in from forty-five to fifty minutes; as soon as the curd breaks clean over the finger it is cut up into small pieces with knives, both vertical and horizontal, and left undisturbed for from ten to twenty minutes. Sometimes the curd is cut four times, at intervals of five minutes.

The curd is then allowed to pitch, or settle, for about half an hour, and the whey is removed in the same manner as described in the Leicester system of manufacture. It is then placed in a drainer and afterwards put under pressure for twenty or thirty minutes; the curd being subsequently broken with the hands into large lumps and again put under pressure. This process is repeated four or five times, more frequent breaking being required for rich curd than for poor. After this the curd is weighed and a little old curd from a previous day's making added to it, when the whole is ground and salted at the rate of 1 oz. of salt to 3 or 4 lb. of curd. This is mixed in at a temperature of from 68° to 72° F., and the curd is afterwards filled loosely into moulds and kept in a room at a temperature of 60° F.

The cheeses are made in various weights from 45 to 50 lb. down to a "loaf" cheese, weighing only 12 to 15 lb. At first a pressure of from 8 to 10 cwt. is used for an hour or two, and the cheese is then put into a dry cloth. It is then returned to the press under from 15 to 20 cwt. pressure, and left there for about an hour, until the coat has formed. It is then bandaged and returned to the mould with the ends reversed. Subsequently, the outsides of the cheese are smeared with a little lard to prevent cracking, and it may then be removed to the curing-room; greased again with lard or butter in two days' time, and turned every day until ripe. The cheeses should be stored in a dry room where a temperature of from 60° to 65° F. can be maintained.

**Gloucester Cheese** is very fine flavoured and only second in quality to Cheddar, to which it is similar, but less waxy in texture. Both single and double Gloucester cheeses are made, but only differ in size and thickness. The single cheeses measure about 14 inches across and are 4 inches deep, and the latter are thicker and larger and weigh as much as 40 lb. Double Gloucesters are often of double thickness. A typical cheese of this sort should have a fairly tough and solid skin, be free from cracks, with sharp well-defined edges, and of a clear yellow colour. The process of manufacture is practically the same as that adopted in the Derbyshire system, except that the Gloucester makers use a wire curd breaker instead of vertical and horizontal knives.

**Caerphilly Cheese.**—These cheeses are made almost exclusively for the miners of Wales and the northern counties. They have a fine and rather acid flavour, are entirely distinct from any other variety, and measure about 10 inches across and 3 to 4 inches in depth, the weight of a single cheese being from 7 to 10 lb. The milk is set at a temperature of 84° F., and, if too sweet, a starter is added at the rate of from  $\frac{1}{4}$  to 1 per cent. When a 23 seconds coagulation is given, 1 drachm of rennet is stirred into every 4 gallons of milk for from four to five minutes—the scum being skimmed off by means of a piece of muslin stretched over a small hoop. The milk is then allowed to settle for four minutes. Any cream that has risen in the interval is carefully stirred into the milk.

In fifty minutes, or as soon as the curd breaks clean, it will be ready for cutting. At first it should be cut lengthways and crossways with the vertical knife, and then lengthways with the horizontal knife, being finally cut into  $\frac{3}{4}$  in. cubes. The curd is then stirred from the bottom and sides of the vat for five or six minutes, and afterwards scalded to 92° F. in forty-five minutes, or at the rate of 1° rise in every five or six minutes. When the fragments of curd contain no whey on being split open, a test should be made with the hot iron, and as soon as  $\frac{1}{2}$  in. threads can be drawn the whey should be run off and the curd scooped into a cloth; the cloth tied and turned over on the knot, and a small weight placed on the top. After twenty minutes the curd is turned out and cut into 3 in. cubes, tied up again, and weighted. This process may be repeated at intervals of about twenty minutes, until 1 in. threads can be drawn out by the hot iron.

The curd is then ground into small pieces the size of walnuts, and 1 oz. of salt is stirred into every 3½ lb. of curd, the temperature at this stage being about 75° F. The moulds are prepared by lining them with a cloth, and the curd is filled into them, so that the smallest pieces lie at the top and the bottom and the largest in the middle. After about three hours, screw pressure should be exerted until the evening, when the cheese must be turned into a fresh cloth and put back in the press under 15 to 18 cwt. pressure. The cheese is turned the following morning and again placed in the press for two or three hours, and is afterwards taken out, greased all over with hot lard, and finally bandaged. In the ripening-room it should be turned twice daily for the first week, and afterwards once daily, until four to six weeks have elapsed, when the cheeses are usually ready for market.

#### BLUE-VEINED CHEESE-MAKING.

**Stilton.**—A choice Stilton cheese is unrivalled in flavour and quality; it has a fairly open texture and a brown, rough, crinkled coat, with veins of blue mould throughout. This cheese is now made from new milk alone, with no cream, from the previous evening milk; 2½ drachms of rennet to every 15 gallons of milk is stirred in at a temperature of 84° F. for about eight or ten minutes, and coagulation is allowed to proceed for about an hour. When the curd is firm enough, the whole is ladled out into straining cloths, about 1 yard square, and placed on a frame in a draining sink. Each of these cloths should hold from 3 to 4 gallons, and after the curd has stood in its whey for an hour or so, the cloths are lifted out of the sink and tied into bundles at the four corners, the bundles being gradually tightened at intervals of half an hour, according to the degree of acidity present, which is usually from 0·13 to 0·14 per cent.



FIG. 237.—Stilton Cheese Hoop.

The curd is then turned out into the drainer and allowed to drain slowly until the whey shows 0·25 per cent of acidity, the bundles being piled on one another in the meantime.

The curd is cut at 0·25 per cent acidity into 4 in. cubes and left overnight to drain. Salt is added at the rate of 1 oz. to 4 lb., and the curd is then filled into Stilton moulds (Fig. 237) placed on calico cloths. The temperature of the curd should be about 65° F. The moulds are placed on a drainer, turned twice during the first two hours, and again in the evening. They are turned daily for about nine days, the cheeses being skewered for the first three or four days, and the outside of the moulds regularly washed with lukewarm water.

When the cheese slides easily out of the mould it must be scraped with the flat side of a knife, a little hot water being used at the same time to moisten the outside of the cheese. It should then be bound with grey calico and scraped down again every day until the proper coat has formed. This takes place most satisfactorily at a temperature

of 60° F. White mould will commence to form as soon as the coat appears, and no further scraping must then be done. White crinkled patches will begin to form, and these spread over the surface in a few days. The coat is completely formed in about a month. The cheeses should be turned daily and placed in a ripening- or curing-room at a temperature of from 55° to 60° F. They will have become thoroughly mature in about six months.

**Wensleydale Cheese.**—This is a blue-veined variety which occupies a position midway between Cheddar and Stilton. The cheeses are made in Stilton shape, and also flat after the style of truckle Cheddars; about 1½ lb. of curd being obtained from each gallon of milk. In texture it is very similar to Stilton, but the mould is more mixed throughout the cheese. Wensleydale cheese is softer and more mellow than Stilton, and has a milder flavour. The coat is smooth, and it is one of the few blue-veined cheeses that are subjected to pressure. The one great drawback in the manufacture is the uncertainty of the development of the desired mould. Another Yorkshire-dale cheese which has attained a considerable local reputation is the *Cotherston*.

Perfectly sweet fresh milk is essential to the manufacture of Wensleydale cheese, the evening's milk being taken direct to the dairy and cooled to 60° F. After mixing the morning milk and the cream with the evening milk, the whole is heated to 80° or 88° F., according to the state of the weather, and 1 drachm of rennet mixed with a little cold water is stirred in for about five minutes. A small quantity of starter (1 oz. to 12 gallons) should be added where mixed milk is used, and the temperature is lower than usual, but otherwise this is not necessary.

About an hour after renneting the curd will be ready for cutting, once each way with the vertical knife and once across with the horizontal knife, into ½ in. cubes, which are then allowed to settle for a little while, and gently stirred for about a quarter of an hour. After this it is left undisturbed for about thirty minutes, according to the weather.

The curd is scalded while still in the whey for half an hour, and as soon as the acid test shows from 0·13 to 0·14 per cent it may be allowed to pitch and the whey be drawn off; the curd is then cut up the centre and allowed to drain for about ten minutes, and is afterwards cut into strips, placed in a cheese cloth, and left on the rack for twenty minutes. This process of opening out, cutting, and turning is repeated every twenty minutes until sufficient acid has been developed in the curd to necessitate it being broken up and scalded. No pressure is exerted on this curd, either with racks or with weights, but if the development of acidity progresses too rapidly it may be advisable to exert a slight pressure of, say, 12 or 14 lb.

The curd may be ground in a mill or broken by hand. It is usually stirred by hand for about five minutes, and left in the whey until the acid test shows from 0·15 to 0·16 per cent, at which stage it is removed on to a cooler, and in twenty minutes is tied up in cloths and the whey let off. In about a similar length of time it is cut into large-sized squares and piled up, which process is repeated twice, at intervals, until the acid test shows 0·4 per cent. The curd is then

broken by hand and 1 oz. of salt is added to every 4 lb. The curd is then filled into cloths in moulds and allowed to remain overnight. Early on the following morning the cheeses are placed in the press, removed again in a few hours, turned and changed into a fine muslin cloth, and returned to the press under about 3 cwt. pressure. Subsequently they should be bandaged with a plain linen bandage, and kept in the drying-room for from seven to ten days until a coat has formed. They should then be removed to the ripening-room and kept in a moist atmosphere, where they will usually become mature in four to six months.

Dorset Blue Cheese, or "Blue Vinney", is a purely local variety, the mellowness of the curd depending almost entirely upon the cultivation of a proper mould, and the retention of sufficient moisture. It is something like Cheddar in texture, but not so flaky, and it contains slightly more moisture than Gloucester cheese.

This cheese is made from skimmed or separated milk. Usually it is made from skim milk which has been set in creaming leads immediately after it has been drawn from the cow. If separated milk is used, sufficient whole milk should be added to raise the fat percentage to 0.7 or 0.8. The quantity of rennet required is 3 oz. per 100 gallons of milk, and this should be added at a temperature of from 75° to 80° F., according to the weather, the acid test of the milk at this stage showing a percentage of 0.25. When coagulation is complete the curd is cut, broken into fairly small cubes, and allowed to pitch; and the whey is drawn off when the curd has receded somewhat from the sides of the tub, and the whey is showing about 0.30 per cent of acidity. This curd is cut into fine cubes after drawing the whey, which is piled up in the centre of the vat, repeating cutting and piling at intervals, until an acidity of 0.85 has been reached. The curd must now be ground fairly small, and salted at the rate of 1 lb. of salt to every 50 lb. of curd.

It should then be vatted in shallow vats and covered with coarse cloths, wrung out in warm water, and afterwards put in the press under a weight of from 3 to 4 lb. At the end of three hours the cloths should be changed, and the pressure gradually increased at intervals until a pressure of 3 cwt. is reached. This process will generally occupy about three days. If too little pressure is applied, the curd will become filled with holes, into which the cheese-fly can enter, while, on the other hand, if the pressure is excessive the mould will not develop, and the cheese will assume a "flinty" condition. Afterwards the cheese is dipped into strong brine to soften the curd, then it is wiped dry and placed in the ripening-room, where a temperature of about 60° F. should be maintained to prevent excessive loss of moisture. The cheese will usually be fit for sale in about six weeks or two months.



## CHAPTER III.

### SOFT CHEESE-MAKING.

ORIGINALLY the practice of soft cheese-making was derived from France, so that the student will find that the bulk of the varieties made in this country at the present day are of French name and origin, although there are a few kinds that can really be termed English varieties. The beginner cannot, of course, hope to make every one of these different kinds of soft cheeses, but he should find very little difficulty in turning out a good cream cheese at the commencement; after which he may turn his attention to other kinds. The principal varieties are as follows:—

*English*.—Cream cheese (single and double), Colwick or Slipcote, Cambridge or York, Small Wensleydale, New Forest, and Godmanchester.

*Foreign*.—French: Brie, Camembert, Coulommier, Gervais, Pont l'Évêque, Bondon, Livarot, Gerome, Mont d'Or, Void, Gournay, Neufchatel. German and Belgian: Limbourg. Italian: Stracchino.

**Principles of Soft Cheese-making.**—The chief difference between a soft and a hard cheese is that the former contains a very much larger percentage of moisture. This is because one of the first principles in the manufacture is to retain the whey in the curd instead of expelling it, as in hard cheese-making. The whey that escapes does so naturally and without much pressure, and in consequence the cheese is soft in texture and ripens quickly. Neither is the curd cut, but sliced or ladled out in large slices into specially prepared moulds. The latter are usually pierced with a number of holes which help to allow the whey to escape by natural drainage from the curd.

Seeing that the chief object in soft cheese-making is to prevent, as far as possible, the too rapid escape of whey, care must be taken to maintain a temperature that will assist the maker in this respect. Such a temperature will be about 60° F., as a rule. If the temperature of the dairy is too high or too low, the whey will drain away too quickly or too slowly, as the case may be.

As regards the milk supply, one meal's milk may be used, pure and sweet, and rich in fat. Surplus milk of good quality may be used to great advantage for making into soft cheese, but it must not be at all acid; otherwise the acidity present will cause the rennet to produce a hard, firm curd. To produce a soft, tender curd the milk must be set at a comparatively low temperature, and very little rennet used.

The drainage must be even and continuous, and practically everything depends on this. If it is too rapid, as when the temperature is excessive, or the curd has been sliced or ladled out too small, the cheese will be dry and practically worthless. Similarly, if the drainage is too slow, the curd will be of a spongy nature, and the whey that remains will set up undesirable fermentation. Low temperatures are usually responsible for slow drainage, and the product is invariably of poor flavour and quality in consequence. If, in draining, a curd is produced that is too soft in texture, there will be a great deal of fat lost in working, and excessive fermentation will be set up. This sometimes produces swollen cheeses, as gas-producing organisms develop and give the cheese a "pin-hole" appearance.

There are other points in the manufacture of soft cheeses which the student should attend to carefully. Perfect cleanliness is of the utmost importance. All the setting tubs, cloths, boards, straw mats, ladles, pipettes, etc., must be kept perfectly sweet and clean at all times. Chief of all, however, is the importance of an even temperature during the manufacture. A pure brand of concentrated rennet extract should be used, diluting it with water and adding it to the milk when the temperature is settled. To prevent any loss, set the vessel containing the milk in a tub of warm water, while coagulating, the temperature of the water being 1° or 2° above that of the milk. The surface of the milk should be kept well stirred after adding rennet, but discontinued directly the milk coagulates, and the vessel is then covered with a muslin cloth. When the curd eventually "breaks clean", i.e. with a clean, sharp fracture, over the end of the finger or the thermometer, it is ready to ladle out into the moulds. In lading, cut the curd into slices; do not crush it, or fat will be lost.

**Equipment of a Soft Cheese-making Dairy.**—*Wooden Tubs.*—These are necessary for receiving the vessel containing the milk. Tin or earthenware vessels are sometimes used, but they are not so satisfactory as wooden ones, since this material does not conduct heat so readily as tin or earthenware, and as the milk can be more easily kept at an even temperature. If there should be a fall in temperature during this stage, the cream will rise to the surface and be lost in slicing the curd.

*Pipettes and Measuring Glasses.*—A supply of these are required for measuring out small quantities of rennet. They can be obtained, together with all the other necessary appliances, from any dairy utensil manufacturer. The pipettes and glasses should be graduated in cubic centimetres, and these in turn into tenths. Or the pipettes may be graduated in minims. 1 c.c. = 17 minims, and 8 drams of 60 minims each = 1 oz., 1 dram being equivalent to 3½ c.c.

*Thermometers.*—Accurate thermometers are essential. If they are only 1° or 2° out it makes a considerable difference. One is best hung on the wall of the dairy and the other floated in the milk.

*Draining Table.*—This may be of slate or wood, the latter being grooved so as to facilitate the quick drainage of the whey, and should also be on a slight slope.

*Draining Cloths.*—A supply of bleached linen draining cloths is essential. These should be about a yard square, and be chosen fine, medium, and coarse. For cream cheese a "huckaback" cloth is required.

*Boards.*—These are required for setting the moulds on. They should be of hard flavourless wood, about  $\frac{1}{2}$  in. thick, and about 14 inches long and  $8\frac{1}{2}$  inches wide.

*Moulds.*—The best moulds are of tinned ironware, but the Cambridge or York moulds are usually of wood.

*Scoops or Ladles* are required for laddling out the slices of curd into the moulds.

*Straw Mats.*—Home-made straw mats (Fig. 238) of coarse rye or wheat straw strung together, for placing immediately beneath the freshly moulded curd, may be used; or they can be purchased at a small cost. The straws stamp an impression on the curd which is supposed to add to its attractiveness.

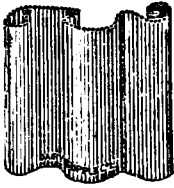

FIG. 238.—Soft Cheese Mat.

*Packing Materials.*—Soft cheeses are dainty table delicacies, and need to be packed and sent out in neat, tasteful packages, otherwise they are robbed of much of their charm. Grease-proof paper should be used for cream cheeses, while some makers put up their Camemberts and Pont l'Evêques, etc., in tin foil. In every case a neat folding cardboard box should be employed for holding the cheese, and an extra strong package if the cheeses are to be sent away by rail. Everything depends on the neat and tasteful way in which these little cheeses are packed and marketed.

The Making-room is of particular importance, and it should be equipped with a heating apparatus, so that the temperature can be easily controlled. One of the first essentials in successful soft cheese-making is to have a fairly warm even temperature, say of 62° to 65° F. If too warm the draining will be too rapid, and a small, hard, and dry cheese will be the result. If the temperature is too low fermentation will be set up and the cheese will contract a bad flavour. Only a single room is necessary where the manufacture is confined to such varieties as are sold and eaten fresh. But when longer-keeping kinds are made, a cool dry cellar or ripening-room will be necessary.

*Ripening Soft Cheeses.*—As the cheeses ripen, fungi will grow on the surface, and the mycelium will penetrate into the curd, permitting enzymes to work in it. These will convert the insoluble curd into soluble and finely flavoured cheese. The process is much the same in many of the different varieties, and there will be found a strong resemblance between Camembert, Coulommier, Bondon, and Brie. At first a whitish mould will develop as a thick, velvet-like "pile" on the surface, but daily turning will break down this tendency. The finished cheeses contain a large amount of moisture, and if they are allowed to become over-ripe the crust bursts and allows fluid curd to escape.

The ripening of keeping varieties is not an easy matter. Unlike hard cheeses of the Cheddar type, there is a large percentage of water to deal with, and unless the cheese is made properly in the first place, with perfectly sweet and fresh milk, undesirable bacteria rapidly develop. Every student knows that bacteria are particularly active in milk-sugar or lactose. Now the moisture in a soft cheese is practically all whey, and this contains milk-sugar, so that bacterial ferments have every chance to work. To produce a really successful Camembert cheese, the genuine Camembert mould (*Penicillium Camemberti*) must be imported from France to inoculate the milk. This is at first white, but afterwards turns a steely-grey as spores are formed. It never assumes the deep-blue tint of ordinary mould; neither does it penetrate into the curd, but grows on the surface, forming spores in about a fortnight, and dries up as a thin crust. *Oidium lactis* develops with it, and helps to ripen the cheese, and these two moulds render the crust slightly alkaline. It is the enzymes which are secreted by the moulds that make the cheeses soft all the way through.

The secret of successful ripening of Camembert, Coulommier, etc., is to get the centre or core of the cheese properly ripened before the outside has become too soft; if the whole of the cheese cuts like thick cream it is certainly of very choice flavour and quality. But most people seem to prefer it waxy and somewhat buttery, although a cheese of this kind is not so highly flavoured. An ideal flavour is generally produced where a moderate growth of *Oidium lactis* is developed, and a brownish tint is given to the outer surface of the cheese.

#### PRINCIPAL VARIETIES OF SOFT CHEESE.

The student is advised not to attempt the manufacture of too many different varieties of soft cheese. The following brief details, however, may serve as a guide, and for more complete instruction we would recommend Tisdale & Robinson's *Practice of Soft Cheese-making and Preparation of Cream for Market*, published by John North, 98 and 99 Fetter Lane, London, E.C., at 1s. net.

**Cream Cheese** is made from pure cream. Thirty cheeses, of from 4 to 4½ oz. each, can usually be made from 1 gallon of cream, and these sell at about 6d. each. Cream cheese can be made with or without rennet, but the renneted cheese is sweeter and, naturally, more weight can be obtained. Thin cream is used in making the renneted variety, and 1 c.c. of it is added to each quart of cream. Coagulation takes place in from eight to nineteen hours, and the curd is then ladled out into finely textured cloths, a gallon of cream to each cloth, tied up by the four corners, and hung up to drain. These cloths should be opened daily, and the hardened cream on the outside scraped down with a knife and mixed with the rest. The more frequent the scraping down, the more rapid will be the drainage. A small quantity of salt may be added after the curd has drained, and the cheese is then moulded in tin moulds (Fig. 239) lined with grease-proof paper.

**Double Cream Cheese.**—Very thick, or even Devonshire, cream, cooled to 63° F., is used for making this variety, and drainage takes place naturally without the introduction of rennet. The cheese is moulded while the curd is still moist and pasty, and in hot weather it is advisable to add a little salt; scrape down more often, and exert some pressure, by placing a board with a light weight on the top of the bag of cream. A good cheese can be produced in from five to six hours, and when it has been moulded in a moist and pasty condition the cheese will keep well for nine or ten days.

**Cambridge or York** is another popular English variety. Three cheeses can be made from 1½ gallons of milk, or a dozen from 7 gallons. The moulds (Fig. 240) are of wood and may be square or oblong in shape, the latter measuring about 7½ inches in length, 5 inches in width, and 6 inches in depth. Fresh, whole milk is heated to 95° F., and rennet is stirred in at the rate of 1 c.c. to the gallon for not more than three minutes, great care being taken to maintain the temperature unchanged during coagulation and drainage. In about an hour the curd will form, and it may then be ladled into straw-mat lined moulds and placed in the draining table. There is no salting or turning in making this variety, and the curd shrinks to a little more than



FIG. 239.—Cream or Bostock Moulds.

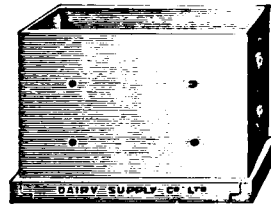

FIG. 240.—Cambridge Mould.

one-third of its original volume in about twenty-four hours. After a similar period of time the cheese should be ready for use. It ought to weigh over 1 lb., and should be consumed when perfectly fresh. It sells at about 10*d.* per cheese.

**Colwick or Slipcote.**—Three cheeses of this variety can be made from 2½ gallons of milk, and 2 c.c. of rennet are required for this quantity. The temperature for renneting is from 84° to 86° F. Circular moulds are used, with perforated sides and bottoms to assist drainage, and a cheese of full size usually weighs about 1½ lb. and is sold at from 8*d.* to 10*d.* The rennet should be stirred in for about six minutes, and the vessel containing the milk is then covered with a cloth. Meanwhile, the moulds are prepared and the curd is ladled into them about an hour after renneting. The curd is then tied up in a cloth, Stilton fashion, and the cloth is gradually tightened as the cheese drains. Usually the cheese may be turned out in about twelve hours' time, and may be ready even quicker by hastening the drainage process.

**Camembert.**—Of the French soft cheeses, this variety is by far the most difficult to make. It is usually made in September and May,

but in hot weather it will not ripen properly, and gives off a somewhat offensive odour. Three cheeses can be made from  $1\frac{1}{2}$  gallons of milk, but often perfectly sweet separated milk is mixed with the new in the proportion of 1 to 5. The milk is not cooled for this variety. It is simply strained into wooden tubs, and the rennet is added at the rate of  $1\frac{1}{4}$  c.c. to  $1\frac{1}{2}$  gallons of milk at a temperature of  $84^{\circ}$  or  $86^{\circ}$  F., and the curd is then ladled into moulds (Fig. 241) and placed on straw mats after about an hour's time. Sometimes the cheese is finished at one operation, but the two-curd system is preferable—half the curd being filled into the moulds in the evening, and the other half on the following morning. This facilitates drainage, and there is less loss of fat, and no need to wait until the curd has settled and cooled. Before renneting, the milk should be inoculated with a starter consisting of  $\frac{1}{2}$  oz. of curd taken from below the crust of a half-ripe French Camembert broken up into very small pieces, and added to  $\frac{1}{2}$  pint of sweet whey at a temperature of about  $80^{\circ}$  F. The mould then makes its appearance on the curd naturally. In the morning, the evening curd will have shrunk considerably and its surface should be broken up and the morning's curd added, the top of the cheese being carefully finished off with a little unbroken curd that has



FIG. 241.—Camembert Mould.



FIG. 242.—Coulommier Mould.

been placed on one side for the purpose. The cheese is carefully turned when the two curds are respectively thirty-six and twenty-four hours old, and  $\frac{1}{2}$  oz. of dry salt is spread evenly over the upper and older surfaces. A second salting is given about six to eight hours later.

**Coulommier.**—This is a small, flat cheese, circular in shape, and measuring about  $5\frac{1}{2}$  inches in diameter, by  $2\frac{1}{2}$  inches deep;  $1\frac{1}{2}$  gallons of milk make three cheeses, which are usually eaten fresh. They improve by ripening for two or three weeks. Whole milk is used, and the rennet is stirred in at the rate of  $\frac{1}{2}$  c.c. to every 3 gallons of milk, at a temperature of from  $80^{\circ}$  to  $86^{\circ}$  F. for about three minutes. Stirring is continued after a pause of another ten minutes, and the tub is then covered with a cloth and left for about three hours, until a thin, greyish whey drains out. Coulommier moulds (Fig. 242) are in two halves, and both are fitted and placed on the straw mats. The curd is then carefully ladled into them, the top halves being removed as soon as the curd has settled low enough, which will take place in about nine hours. A mat and a board should be then placed on the top of the mould, which is turned, and turned again twice daily for from three to eight days, a little salt being rubbed in in the meantime,

as soon as they are sufficiently firm. If the cheeses are to be ripened, they should be kept in a dry, airy room at a temperature of 62° F. for a few days, and afterwards removed to the ripening-room and placed upon latticed shelves.

**Pont l'Evêque.**—This is quite a different type of cheese to the Camembert, and the ripening of it is not dependent upon the growth of moulds, but upon the action of the enzymes of the rennet. The cheeses weigh about 1 lb., and are of a brownish-red colour on the outsides. Two of them can be made from 1½ gallons of milk, and 1½ c.c. of rennet are used. Care is taken to prevent any formation of acid in the milk, the cheeses otherwise drying and hardening too quickly.

The most important point in this process is to know when to hoop or mould the curd; if it is too hard and dry, drainage will proceed too quickly, while if the curd is too moist, or has become chilled, there will be an excess of moisture in the curd. The renneting temperature is 90° to 95° F., and as a rule coagulation is completed in about fifty minutes. The curd is then cut into small squares, and left for five minutes. Afterwards it is ladled into coarse cloths and placed on wooden frames, about 2 gallons of curd being placed in each cloth. These cloths are then tied and tightened every ten



FIG. 243.—Pont l'Evêque Mould.

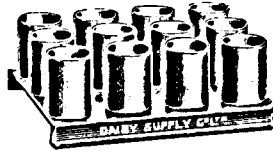

FIG. 244.—Gervais Moulds.

minutes for about two hours, the curd being subsequently broken up and filled into moulds (Fig. 243) placed on straw mats. The moulds are then reversed, and the cheeses are turned again after ten minutes, and transferred on to other mats and so placed that the second impression of the straws is at right angles to the first. They are then turned again hourly for about three hours and a little salt is rubbed over the surfaces the next day, or as soon as the cheeses smell yeasty and are a little greasy on the outside. The object should be to secure a close, tight surface; otherwise the cheese will lose moisture by excessive drainage, and be spoiled. As soon as a white mould has appeared, the cheeses should be removed to a curing-room or cellar, and kept there at an even temperature of from 58° to 60° F. They will become thoroughly ripened in from five to six weeks.

**Gervais.**—These cheeses are made from fresh whole milk, to which has been added half its volume of cream. A dozen cheeses can be made from 2 quarts of new milk and 1 quart of cream, and ½ c.c. of rennet is added at a temperature of from 60° to 65° F. Coarse huckaback cloths must be used, into which the curd is ladled, and these are hung up in the dairy to drain, but not in a draught. As drainage slackens, the stale and thickened curd is scraped down in the cloths,

and afterwards the whole is turned into a bowl and salted. Gervais or Bondou moulds (Fig. 244) are made in dozens, of tin, on a tin stand or framework, and are lined with blotting-paper, and placed on straw mats on boards. Press the curd into the moulds firmly, and then remove the latter, leaving the cheeses standing on the straw mat.

Apart from the above-mentioned varieties, there are also a number of proprietary soft cheeses on the market which are said to possess special medicinal properties, owing to the fact that they contain, or are ripened by lactic acid ferments or pure cultures of *B. bulgaricus*.



PART V.

*HORTICULTURE.*

# PART V.

## HORTICULTURE.

---

### CHAPTER I.

#### PLANT LIFE.

**Introduction.**—In order to understand the reasons for the various operations of agriculture and horticulture it is necessary to possess some knowledge of the structure and physiology of plants, that is, how the various parts of plants are constructed, and the work which these parts perform. We must, for instance, know something of the sources whence the plant obtains its food; the processes by which the simple inorganic substances taken up by the plant from the soil and from the air are converted into the complex organic substances of which the plant is made up; the methods and the channels by which the raw materials and the elaborate foods are carried from place to place within the plant, and the influence which the various external factors of the plant's environment, in the widest sense, exert upon the life, nutrition, and growth of the plant.

**Root and Shoot.**—If we examine a number of common flowering plants we shall find that two sharply distinguished kinds of organs may be recognized. The *root* (radicle) grows downwards into the soil, bearing rootlets and root-hairs; the *shoot* (plumule) grows upwards into the air, bearing leaves, branches, and flowers. A good method in which to begin the study of plant life is to raise seedlings; for in the seed we have a young dormant plant of very simple form; and germination, which is simply the awakening into active life and growth of this dormant germ, brings us at once face to face with important questions as to the necessary conditions for promoting this wonderful process. In most cases such questions can be answered, at any rate in part, with the aid of experiments and observations, most of which require no special or expensive apparatus.

**Structure of Bean Seed** (Fig. 245).—It is best to examine large seeds, such as beans or peas. A bean seed is dry and hard when in the resting condition, but if it is soaked in water for a few days it becomes soft and swollen, owing to the absorption of water; and if we plant the soaked seed in soil or sawdust, or even simply place it in a glass or other chamber in thoroughly moist air, it will germinate and

give rise to a bean seedling. Water is the first essential of germination, as, indeed, it is for every active process of life. The soaked seed will be seen to show on one side a long mark (*hilum*), which is the scar formed where the seed broke from the placenta of the pod. If the soaked seed is wiped dry and squeezed, we see a drop of water oozing from a very small hole (*micropyle*) at one end of this scar, this being very plainly seen in a scarlet runner or a french bean. We shall see the primary use of this opening later, but, so far as the seed is concerned, it has an obvious use in allowing the entrance of water; it is easy to prove this, for if we take two batches of dry seeds and

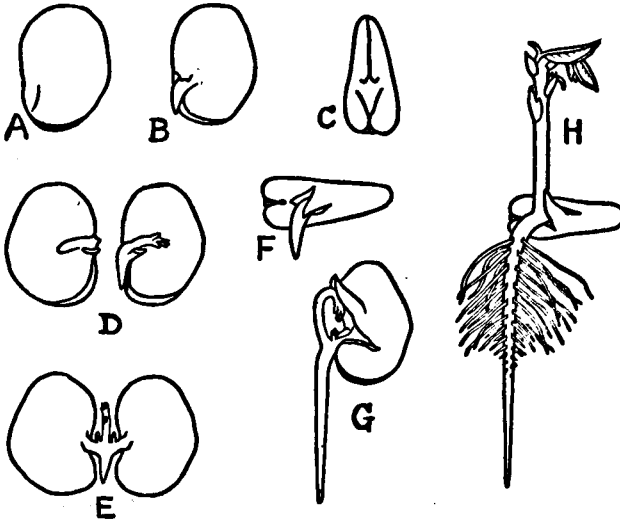

FIG. 245.—Broad Bean Seed and Seedling. A, side view of whole seed; B, side view of embryo after removal of seed-coat; C, front view of embryo, showing radicle in the middle and a cotyledon on each side; D, embryo split apart, showing on the left a cotyledon with groove for plumule, on the right the other cotyledon with radicle and plumule attached to it; E, embryo opened, showing outside surfaces of cotyledons; F, early stage in germination, the radicle has grown out of the ruptured seed-coat; G, later stage, showing emergence of the plumule; H, still later stage, showing radicle with rootlets and plumule with young foliage leaves.

seal up the holes in one batch with sealing-wax, and weigh the two lots, placing both lots in water, we shall find that the closed seeds absorb water more slowly than the others.

If we cut across a soaked seed, or even pick at it with the finger-nail, we find it is covered by a *coat*, and on removing this we find that the contents of the seed consist mainly of two large hemispheres (*cotyledons*) with their flat faces in contact. The cotyledons are joined together at one point, at which we notice two other bodies, one smooth and pointed, and soon seen to be the embryo root of the young plant. The other lies between the two cotyledons,

and appears as a curved body bearing at its free end a number of minutely embryo leaves, which can be seen very plainly with a lens. The first two leaves are very conspicuous, on account of their large size and plainly visible veins, and between them is a minute bud. This leaf-bearing portion is the young *plumule*, and the young root is the *radicle*.

Hence the bean seed contains an embryo seedling, including the two main portions seen in the full-grown plant—namely, root and shoot. After the seed has absorbed water, the contents swell and the coat bursts, and in whatever position the seed may have been placed the radicle grows directly downwards. A little later, the plumule emerges and grows upwards, the stem increasing in length, while the young leaves develop, and become green on reaching the light.

As time goes on, the growing root produces rootlets, exactly like the tap root in appearance, but differing in being more slender and in growing out almost horizontally. It will be noticed that these rootlets

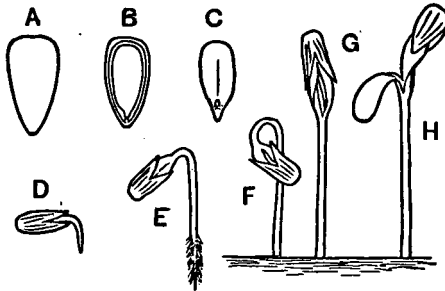

FIG. 246.—Seed and Seedling of Sunflower. A, seed (really a one-seeded fruit); B, the same split open, showing the embryo (covered by the thin seed-coat); C, embryo after removal of one cotyledon, the minute plumule lies above the radicle; D-H, stages in germination (the cotyledons are raised into the air by the elongation of the hypocotyl).

are arranged regularly in rows, along the length of the main root (four rows in runner and french beans, usually five or six rows in broad beans). The shoot is for a time curved, its tip being bent downwards, but it gradually straightens out and the leaves expand; this hooked form of the young shoot-tip is seen in many seedlings, and serves to protect the young leaves as the shoot thrusts through the soil. When the bean seedling has made some growth, it will be noticed that in the angle made by each cotyledon with the young shoot there is a bud, as may be well seen in the broad bean. Now, this position in the angle, between leaf and stem, is exactly the position in which all buds are found on shoots, hence we infer that the cotyledons are leaves—they are, in fact, the earliest leaves of the embryo or young plant, only in the case of the bean the cotyledons remain below ground. If we let a broad bean seedling grow until its plumule has become about 2 inches long, and then cut it off, we shall be making

a simple experiment in pruning, for the result will be the same as in the pruning of a tree, namely, that the two buds in the axils of the cotyledons will soon grow out to replace the lost main shoot, though otherwise these two buds might have remained undeveloped. Hence the bean seed simply consists of an embryo (plumule, radicle, and two cotyledons or seed-leaves) covered by the seed-coat. It may be mentioned in this connexion that the cotyledon leaves of the turnip appear above ground, and actually form the first leaves of the young plant. The seeds and seedlings of the sunflower and maize are shown in Figs. 246 and 247.

Conditions necessary for Germination. — Still using bean seedlings as a type, let us see what conditions, besides the supply of water, are

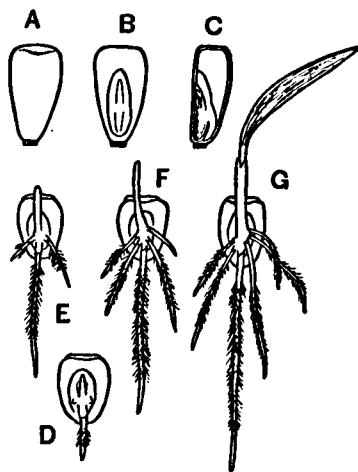

FIG. 247.—Seed and Seedling of Maize. A, B, two sides of the seed (a one-sided fruit with fruit-wall—pericarp, and seed-coat fused to form a single skin); C, section of seed showing the endosperm on the right and the embryo on the left; D-G, stages in germination.

necessary in order that germination may take place. That soil is not essential is easily proved, for seeds will germinate in moist air, and (as we shall see later) we can grow healthy plants from seeds germinated with their roots immersed in water containing certain salts in solution. The only things necessary are warmth, air, and light, and the question is, are all these three conditions essential? The way to examine this problem is simple: in each experiment we must provide all except one of the conditions which appear to be required, having close by, for comparison, a control experiment—that is, one in which all the conditions are provided—and note the result.

That some *warmth* is needed is shown by placing soaked seeds in different temperatures. In winter, all we need to do is to set one

pot of seeds out of doors and a second pot indoors, while in summer we can surround one pot with ice. Results show that for each species of plant there is a certain *minimum* temperature, below which germination will not take place. There is also an *optimum* temperature at which germination will take place best, and a *maximum* temperature above which germination will not take place at all. This is an important general rule which applies to all vital processes—the rule that for temperature and other controlling factors, such as light, there is a certain range, including a minimum, an optimum, and a maximum; below the minimum, or above the maximum, activity ceases, and in extreme cases death occurs.

That *air* is necessary for germination is easily proved. Place one lot of seeds at the bottom of a jar filled with water, and drive off the dissolved air by boiling and allowing it to cool down before placing the seeds in it; and place a second lot of similar seeds in an open jar, with only a little water to keep them moist. By such methods as these we find that seeds must have air in order to germinate. A neat method is to take a set of five tall glass jars of similar diameter. Into one is placed a little wet sand to form a thin layer at the bottom, and each of the others is divided into fifths, by gumming strips of paper on the outside. Fill jar No. 2 with sand to the first mark, jar No. 3 to the second, and so on, so that we shall have five jars containing different volumes of supernatant air—jar 5 containing one-fifth as much air as jar 1, jar 4 containing four-fifths, and so on. In each jar we place an equal number of soaked seeds (e.g. wheat or mangold), and tightly close the mouths with a stopper or cork greased with vaseline, in order to make it air-tight, and note the results after several days. The seedlings with the largest amount of air at their disposal make most growth, and the amount of growth, as measured by the length of the shoots, is proportionate to the volume of air supplied to the germinating seeds.

Another interesting experiment may be made, by placing soaked seeds at different depths in soil, or sawdust, in a germination box with glass front, and noting that the deeply buried seeds either do not germinate at all, or grow badly, and soon die without reaching the surface; this is due, in part at any rate, to lack of air in the deeper parts of the soil. There is also less circulation of air, and too much water, leading to damage by fungi and bacteria.

*Light* is not essential for actual germination, though of course all-important for the subsequent healthy growth of the seedling. Two lots of seeds of the same species should be taken, one lot being grown in total darkness, and the other in the light—other conditions being as nearly alike as possible—and the differences between the germination of the two sets of seedlings noted after some days.

We shall return to some of these experiments on germination later. Meanwhile, we must consider some of the questions arising from the study of germination itself. The germination of a wheat grain is shown in Fig. 248.

**Chemical Analysis of Plants: Water Culture.**—Since the food of man and of animals is obtained, directly or indirectly, from plants, it becomes a question whence plants obtain their food. It must be borne

in mind that we are considering at present only green plants, possessing the green substance, chlorophyll. It was once thought that all plants simply suck up the substances which they contain from the soil. This of course would mean that all the thousands of substances found in plants (starch, sugars, oils, resin, etc., etc.) must have been present in the soil as such, which appears absurd to us, though it was believed for a very long time—in fact, until men began to make simple experiments.

Van Helmont (1577-1644) dried some soil, and placed 200 lb. of it in a pot, stuck into the soil a willow branch weighing 5 lb., covered the soil to exclude dust, and watered it daily with rain-water. In five years the willow had grown large and strong, and had increased in weight by 164 lb., but the soil in the pot, when once more dried, only showed a loss of 2 oz. From this result, Van Helmont concluded that the increase in weight of the plant had been gained entirely from water; he came to the conclusion that all the materials in plants,

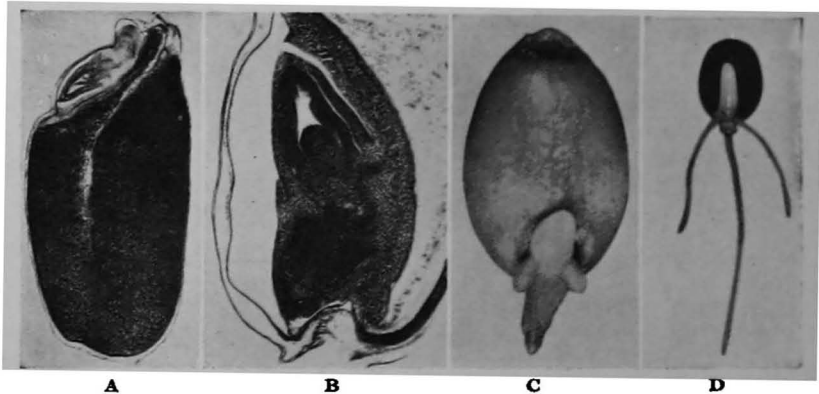

FIG. 248.—Germination of Wheat Grain. A, longitudinal section through wheat grain showing embryo; B, embryo of wheat grain, highly magnified; C, germination of wheat grain; D, later stage of germination.

though distinct from water, come from it. This experiment at any rate disposed entirely of the old fallacy referred to, and is therefore of the utmost importance.

If we make a chemical analysis of any flowering plant, we shall find, that after driving off the water, which all tissues contain in greater or smaller proportion, and incinerating the dry matter, the remaining ash contains a considerable number of chemical elements, some of which occur in large quantities, and some as mere traces. Many such analyses have been published, so that details need not be given here. We can find out, however, just which of these ash constituents are necessary for the healthy growth of the plant. By this means we find that for healthy growth the normal or complete solution must contain the nine elements potassium (K), calcium (Ca), Magnesium (Mg), sulphur (S), phosphorus (P), iron (Fe), hydrogen (H), and oxygen (O). As to the all-important element, nitrogen, it is omitted at the moment, merely because it is not found in the ash

constituent of plants, with which the above remarks are chiefly concerned.

If the roots are supplied with a solution from which any one of these nine elements (and nitrogen) is omitted, the growth will be relatively poor and unhealthy, and cease altogether as soon as the plant has exhausted such store of the omitted element as may already be present in its own tissues (in the food-store of the seed, for instance). It may be noted that for some plants sodium and chlorine are beneficial, though not absolutely necessary, e.g. mangel and beet; while for grasses and cereals, silicon is similarly useful; but, of course, the elements sodium and chlorine are always present in the soil (as common salt, sodium chloride, Na Cl); while silicon is found abundantly in all soils, except those entirely composed of humus or peat.

The methods of water-culture (or sterilized sand culture) thus enable us to determine exactly which of its elements the plant obtains from the soil, and it has, of course, an important bearing upon the use of manures and fertilizers, the object of which is to supply the soil with any elements in which it is lacking—either naturally or through the continued removal of crops. Again, it is found (both in water cultures, and in agricultural practice) that different plants, while all requiring the essential elements above mentioned, take their different foods in different proportions from the soil. This applies especially to nitrogen, sulphur, phosphorus, lime, and potash; and fertilizers are chiefly intended to supply deficiencies in one or other of these five principal ingredients.

In proceeding with plant analysis, we first dry the plant thoroughly in the sun, or in an oven with gentle heat, to expel the free water, and give us the "dry weight" of the plant. The proportion of water present varies greatly in different plants, and in different portions of the same plant; or even in the same portions at different stages of growth. The proportion may be as high as over 90 per cent in fruits and vegetables, and even in the woody portions it is usually at least 50 per cent. When the dried plant is burnt, the organic substances of which it largely consists are converted into inorganic substances, chiefly carbon dioxide and water, which escape in the process of burning; the nitrogen also disappears into the air. If the dried substance is charred, instead of being entirely burnt, we get charcoal, and if the carbon dioxide given off in complete combustion is collected and weighed, we shall find what a large portion of the dry weight is represented by carbon—usually as much as one-half. The incombustible residue, or ash, represents the mineral substances already named; though in the process of burning these undergo changes, and therefore appear in the ash in different combinations from those present in the fresh plant-body itself. The amount of the ash increases with the age of the plant, and varies in different plants, and in different parts of the same plant, and also at different stages of growth.

**Microscopic Structure of Plants.**—We may make a different kind of plant analysis, by examining with the microscope the structure of the various parts, usually by cutting sections thin enough to be transparent. We find that all parts of a flowering plant are made up of



closed chambers called *cells*, or of structures which have been derived from cells—the important vessels of the wood, for instance, are developed from longitudinal rows of cells, that have united to form continuous tubes. Cells vary in size and form, but all agree in consisting (at any rate when young) of a mass of *protoplasm*; each cell contains a special protoplasmic body called the *nucleus* which is generally enclosed in a *cell-wall*. Protoplasm is formative matter, and is largely composed of the complex organic compounds called *proteins*; the cell-wall, as apart from protoplasm, consists of *cellulose*, which belongs to the *carbo-hydrates*.

The only parts of a plant which are alive, or capable of growth and other vital processes, are those in which there are cells containing protoplasm—"the physical basis of life" as it has been called. Carbon is an essential constituent of all organic substances, and the mere fact that the six elements just named make up the protoplasm, shows that we must add carbon to the list of essential elements for plant growth.

There are, therefore, ten essential elements for the life and growth of green plants. Carbon need not be supplied in the culture solution, and, in fact, it is not utilized by the roots of a plant even if it is supplied. Hence we conclude that carbon must be absorbed from the air in the form of carbon dioxide, which is everywhere present in the atmosphere. The amount of rain-water absorbed by the aerial parts of plants is usually so small as to be negligible.

**Growth of Root and Shoot.**—In order that a plant may manufacture organic substances from the water and salts imbibed by the root, and the carbon dioxide absorbed by the leaves, it is clear that these organs must be well developed. Hence the root must grow and branch in such a way as to come into contact with as much soil as possible, and in the most efficient and economical manner; while the leaf must be spread out to the air, so as to absorb as much carbon dioxide as possible. The form and structure of roots and leaves are well adapted for these purposes, as well as for their other functions. We must therefore know something of the structure of the root and the leaf, and also of the stem which serves as a link between the two absorbing organs and fulfils many functions.

We have seen that the primary root (radicle) of a seedling grows directly downwards into the soil, while the first set of branch-roots, arising from the radicle, grow out in a nearly horizontal direction. The third and subsequent orders of branch-roots grow away from their parent root, so that some may grow upwards, some downwards, others horizontally. If a bean seedling is grown in a transparent box, until the radicle has produced secondary roots about an inch long, and the positions of the radicle and its rootlets are marked from the outside of the glass, and if the box is then tilted to an angle of 45°, we shall find that, after a time, the main roots will turn in such a way that their further growth returns to the original directions. If roots of the third order are present, however, these simply grow out at right angles to their parent-root, in whatever position the box is placed. When rotated on a clinostat, the root and shoot, if placed horizontally to begin with, simply continue to grow horizontally; whereas if

a seedling, or a pot plant, be laid horizontally at rest, the shoot will after a time curve upwards and the root downwards. The roots of the third orders, however, make no response to the gravitation stimulus—they simply grow out, away from their parent-root.

The main root (Fig. 249) is said to be *positively geotropic* (i.e. grows vertically downwards), the main shoot *negatively geotropic*; the first branches of the root, and most stem branches and leaves, respond to the gravitation stimulus by growing more or less horizontally instead of in the vertical line, and are termed *diageotropic*; while the later branches of the root are not geotropic

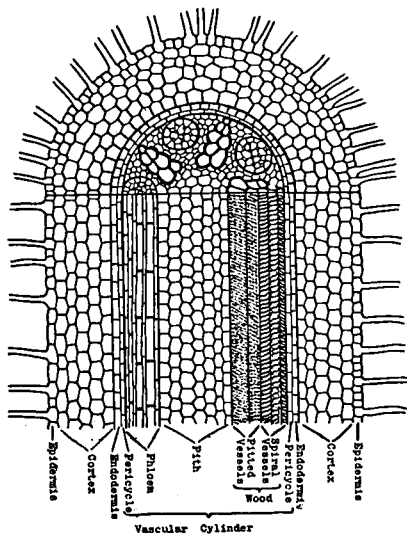

FIG. 249.—Partly diagrammatic representation of the primary structure of a Dicotyledonous Root, shown in transverse section above and in longitudinal section below; one-half of the transverse section is shown. The root has five wood bundles and five phloem bundles in all. The numerous root-hairs arising from the epidermis (also called "piliferous layer") are cut short; these hairs are in reality long filaments, their length being several times the diameter of the young root.

at all, but are called *exotropic*. The main point with regard to the root is, that by these different directions of growth of main root and rootlets these thoroughly explore the soil, without getting into each other's way, and thus more efficiently fix the plant, and absorb soil-water.

The absorption of soil-water, as well as the fixing of the plant, is further increased very greatly by the fact that just behind the tip of the root, and each of its branches, the surface layer of cells (*epidermis*) produces large numbers of fine thread-like cells, or

root-hairs (Fig. 250), which may increase the surface of the root by as much as sixty times. The root-hairs have thin walls and readily absorb the soil-water, which is passed upwards through the root itself into the stem, and then to the leaves and other parts. The process of absorption depends upon the principle that when two liquids of different densities (for instance, two solutions of different strengths) are separated by a thin membrane, the less concentrated solution passes through the membrane more rapidly than the stronger one. This process, called *osmosis*, is easily illustrated by filling a jar with syrup, or with a strong solution of sugar or of salt, tying over its mouth a piece of parchment or pig's bladder, and immersing it in a basin of water. The membrane after a time is bulged out, because the strong solution has absorbed water, and by testing the water outside we find that some of the solution has passed out (*exosmosis*).

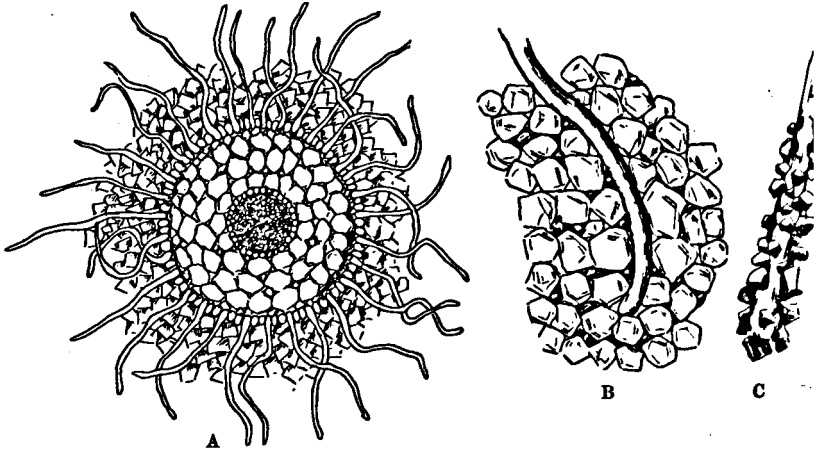

FIG. 250.—Root-hairs. A, section of root showing structure of root-hairs; B, root-hair highly magnified in contact with soil particles; C, root-hair with soil particles adhering.

The interpretation as applied to the root-hairs is obvious. The sap inside the hair represents the sugar or salt solution, indeed it contains sugar and other substances serving the same purpose of "attracting" water; the membrane is represented by the thin cell-wall of the hair; and the soil-water is the dilute solution on the outside of the membrane. As might be expected, we find that the solution may be forced into the conducting channels of root and stem under considerable pressure; set up in the first instance in the root-hairs by the process of absorption, or osmosis.

If we take a bean seedling, with a radicle about 2 inches long, and dry it, by stroking it gently with filter-paper, and carefully make on it Indian-ink marks at intervals of one-tenth of an inch, and then let it grow in moist air (e.g. down the tube of a funnel set in a vessel of water, with wet filter-paper or damp cotton wool around the seed),

we shall find that after a few days the marks will have become spaced out very unequally—those nearest the tip of the root are widely spaced out, while those further back remain unaltered. That is, growth, in length, is confined to a very short region behind the root tip. We shall find also that the production of root-hairs begins some distance behind the tip, and that of the rootlets further back still. The explanation is that if hairs and rootlets were produced on parts growing actively in length, they would be injured by friction with the soil; hence growth in length is confined to a zone near the tip, and the hairs and rootlets are produced further back.

Since the radicle, in making its response to the stimulus of gravitation, will grow downwards against considerable resistance, and the rootlets must also burrow through the soil, the delicate tip of the root must be protected against injury. The tip of the root is covered, for this purpose, by a conical mass of tissue, the *root-cap*, the outer tissue of which is continually worn away at the surface, and renewed from within. The tip of the *stem* does not require a special protection of this kind, since it is covered by the youngest leaves, which curve over it, and prevent injury of the delicate growing tissue from drought, etc.

**Photosynthesis and Respiration.**—The central fact in the physiology of the plant is *photosynthesis*—a series of processes by which the living protoplasm of green cells is enabled, by utilizing the energy of sunlight, absorbed by the chlorophyll, to rearrange the elements carbon, hydrogen, and oxygen of all the carbon dioxide of the air and water in such a manner as to build up organic substances of increasing complexity. The carbo-hydrates (sugars) produced by photosynthesis are, later, combined with nitrogen, sulphur, and phosphorus absorbed from the soil, so as to form nitrogenous organic substances, producing proteins; and the whole series of building-up, or synthetic process, culminates in the forming of protoplasm itself.

Some of the points in this brief summary of an important chain of processes may now be explained in detail. We may again go back to the germinating seed, as a starting-point. In all seeds, a certain amount of organic food substance is stored up for the use of the young plant. In some seeds this food is contained in the embryo itself (usually in the cotyledons); while in others it is contained in a special tissue, the *endosperm*, lying within the seed-coat but outside of the embryo itself. In the first case the seed is said to be *non-endospermic* (e.g. beans, peas, turnip); in the second case *endospermic* (e.g. wheat, buckwheat, mangold). The food may be of various kinds. *Proteins* are always present, together with either *starch* or *oil* or other less common substances. There is also a certain amount of mineral matter and some water, even in apparently quite dry seeds—not enough to allow germination to take place, but enough to keep the young plant alive, for if a seed is thoroughly dried the embryo is killed.

Now, these reserve foods in seeds are either absolutely, or relatively, insoluble in water, since the passage from one part of a plant to another is blocked by innumerable partitions (cell-walls). It is obvious

that in order to be moved about in the plant, food substances must be soluble and able to diffuse through membranes. Starch, oil, and proteins are either only slightly soluble or quite insoluble, and indiffusible; hence they cannot be transported, as such, to parts where growth is taking place, and where food is required. The difficulty is solved by the conversion of these stored foods into other substances, which are readily soluble and diffusible, and the converting process is in each case performed by a ferment or *enzyme*, a special kind of the ferment diastase. Other ferments change proteins into simpler substances called peptones, and others again change oils into simpler substances, which are soluble and diffusible. Many familiar processes are due to these ferments. For instance, the first stages in brewing depend upon the presence of diastase in the barley grain; the seeds are allowed to germinate, and the diastase converts the starch, stored for the young plant's use, into sugar.

When a seed is soaked, and supplied with warmth and air, the cells produce the appropriate ferments, and the reserve substances are acted upon by these, and made available for the use of the growing root and shoot. Hence, for a time (depending practically upon the size of the seed), the young plant may grow without any outside food supply. For instance, a bean seedling will grow for a long time, if supplied with only distilled water, and may even be brought to flowering and the production of seeds, provided it is exposed to light, and given sufficient warmth and air. It is owing to this food-store that seeds provide such excellent material for experimenting on the growth of plants under the simplest conditions, and to some of these we now turn. When a plant is growing, it is of course doing work; and the organic substances which it contains must be undergoing waste, just as in the case of an animal doing work. This waste must be made good by a supply of food, otherwise starvation and death will ensue.

The food contained in a seed, after having been converted into suitable forms, represents a supply of force, or energy, in potential form; but this must now be converted into free energy, besides providing material to repair waste. In a germinating seed, just as in an animal, the conversion of potential into free energy is brought about by the combination of oxygen with the tissue materials; the process being one of respiration or combustion, in which sugar, for instance, is oxidized, setting free not only energy but also matter in the form of carbon dioxide and water. That germinating seeds consume the oxygen of the air, and give out carbon dioxide, is easily shown by placing soaked seeds in a closed vessel; and, after a few days, testing with lime-water.

To repair the waste of energy, and material, entailed in growth and vital processes generally, the plant must obtain a supply of material and energy from outside. In the case of green plants, the sources of material are the air and the water and salts in the soil, and the source of energy is the light. The importance of chlorophyll is apparent when we ascertain that a solution of it, made by steeping leaves in alcohol, shows a characteristic absorption spectrum, with dark bands in the red and blue regions. That is to say, the chlorophyll absorbs the red and

blue rays of light ; and experiments with plants grown under coloured glasses, or under the purer coloured light obtained by using screens, such as flat bottles containing solutions of aniline dyes, prove that the light rays absorbed by chlorophyll are just those which promote the process of photosynthesis.

Although the subject of photosynthesis is a difficult one, the general conditions under which photosynthesis occurs are, fortunately, easy to demonstrate by experiment. In the great majority of plants, part of the sugar formed as a result of photosynthesis is temporarily changed into starch, the presence of which in the leaf is easily detected by using iodine solution, i.e. after placing the leaf in boiling water for a few minutes, and then steeping it in alcohol to remove the chlorophyll. During the daytime, therefore, starch accumulates in the leaf, and at night this starch is changed back into sugar (by the action of diastase), and part of it, as well as part of that formed during the daytime, is used by the leaf itself, while the rest travels to various other parts of the plant, which require food either for growth or for storage.

In starting any experiment on photosynthesis all we have to do is first to place the plant in darkness for a few days, so that any starch present in the leaves shall be changed into sugar, and we then begin our experiment with starch-free leaves.

That *light* is necessary, is proved by placing a strip of tin-foil across a leaf, or a stencil with letters, or some other pattern ; or a photographic negative, and, after exposure to light, and testing with iodine, we shall find that starch has been formed only where the light reached the leaf. If a photographic negative is used, we get a starch-print, the light parts of the negative showing up dark, and vice versa, after the leaf has been treated with iodine. That *carbon dioxide* is necessary is proved by placing a leaf halfway (through a split cork bung) into a jar containing some caustic potash (to absorb any carbon dioxide in the air), while the leaf-stalk outside the bottle dips into water ; the part of the leaf inside the bottle (in air deprived of carbon dioxide) produces no starch, the part outside (in ordinary air) does. That *chlorophyll* is essential is proved by experimenting with variegated leaves, the segments without chlorophyll making no starch, while the green parts do.

**Transpiration.**—Another process which is related to photosynthesis is that of transpiration. Experiments on root absorption show, that the root-hairs cannot absorb a strong solution of salts from the soil ; and that in order to obtain the quantity of salts required, the plant must take in an excess of water, beyond what is actually required in order to bathe the tissues, and to provide the amount of water used up in photosynthesis. This excess of water is got rid of mainly in the form of water vapour, which is given off by the leaves, mainly through the stomata in the epidermis. This giving-off of water vapour by the leaves is called transpiration ; but we also have to consider the current of water (*transpiration current*) which flows up the stem from roots to leaves.

Although the precise explanation of the rise of this current is rather difficult to understand, the main facts are simple enough, and

it is easy to show that the leaves give off considerable quantities of water in the form of vapour. This can be shown simply by placing a plant under a bell-jar and noting that the transpired water vapour is condensed on the inside of the glass ; or we can weigh the water given off by placing with the plant, under a glass, some weighed dry calcium chloride which absorbs water vapour readily from the air ; or we can place in contact with the leaf itself a piece of filter-paper soaked in cobalt nitrate solution and then dried ; the dried cobalt paper is blue, but becomes pink on being moistened.

The actual current of water up the stem can be made visible and measured in various ways. To demonstrate the rise of water, and at the same time show the channels along which it flows, place the lower cut end of a stem in coloured water, which will ascend in the wood of the vascular bundles and finally reach the veins in the leaves. To measure the rate of the current the simplest method is to use a potometer, consisting essentially of a vertical narrow glass tube open at the top, connected at the base with a vessel filled with water, into which the cut end dips, the junction being air-tight ; as the stem draws up water from the larger vessel the column of water in the narrow tube sinks, and, if graduated, the quantity of water which is exhaled by the leaves in a given time can be recorded. With such an apparatus we can show that the rate of the transpiration current varies according to external conditions. As might be expected, we find that it is increased either by warmth, dryness of the air, or by wind. Up to a certain point, therefore, transpiration is regulated by the same conditions as evaporation from a free water surface. There is one additional factor, however, which controls transpiration though not ordinary evaporation, and this is light ; in bright light plants transpire freely, but in darkness transpiration practically ceases. This is due to the fact that in light the stomata on the leaves are widely open, whereas in darkness they become nearly closed.

**Structure of Leaf, Root, and Stem.**—Having thus gained some idea of the processes carried on in the living plant, we can better understand how the structure of the various parts is adapted to the functions which these parts have to perform. In fact, the structure of a plant is neither interesting nor intelligible until we know something of its functions, and on the other hand, we cannot properly understand functions without some knowledge of structure.

From a broad point of view the leaf is the most important organ of the plant, some aquatic flowering plants having no roots, while others show no distinction between stem and leaf. In the leaf, the all-important process of photosynthesis is carried on ; from it is given off, as vapour, the excess of water absorbed from the soil ; while it also takes in oxygen and gives out carbon dioxide, and thus it is the main seat of the gaseous exchange involved in respiration—at any rate so far as the above-ground portion of the plant is concerned. The leaf is thus the medium of gaseous exchange between the air within the plant and the atmosphere. These exchanges are concerned in the three processes of photosynthesis (enter carbon dioxide, exit oxygen), respiration (enter oxygen, exit carbon dioxide), and transpiration (exit water vapour).

The *leaf* (Fig. 251) is structurally well adapted to its functions. The typical thin, flat type, consisting of green tissue supported and spread out to the light and air by a network of veins; the *epidermis* with its outer layer of impervious *cuticle*, to prevent excessive loss of water vapour; the *stomata* (Fig. 252) in the epidermis, each stoma being a slit-like opening between two sausage-shaped *guard-cells*; the *intercellular air-spaces*, communicating with the atmosphere by means of the stomata, and continuous also with the air-spaces in the stem and root; the green tissue (*mesophyll*) divided into an upper zone consisting of vertically elongated cells (*palisade tissue*) and a lower zone of branched star-like cells (*spongy tissue*) separated by large air-spaces; the fine *veins* running between the palisade and spongy zones, supplying the green cells with water and salts, and also carrying away from them the organic substances they manufacture by photosynthesis—all these details of structure show how beautifully the leaf is adapted to its important functions.

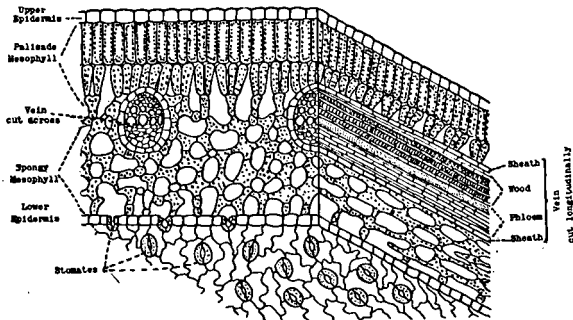

FIG. 251.—Partly diagrammatic representation of the structure of a Foliage Leaf, showing transverse section, longitudinal section, and lower surface.

The structure of the leaf should be thoroughly understood, and for this purpose microscopic examination is necessary, and the following preparations should be made and examined: (1) Pieces of epidermis may be separated from the upper and lower sides of a leaf and boiled in potash. The edges are then cut away with scissors, so that the structure will separate readily into its three parts—upper epidermis, lower epidermis, and mesophyll with veins; or (2) tangential sections may be cut, parallel with the flat surface, at different depths, to show the appearance of the palisade and spongy cells cut horizontally; and (3) thin vertical sections through the leaf will give material for examination. The presence of air within the leaf is easily demonstrated by dipping a large leaf into freshly-boiled water in a tumbler; in many cases the air-bubbles, forced out by the expansion of the air in the intercellular air-spaces, will appear only on the lower side. In preparations stained with iodine, if the leaf has been exposed to light previously, the starch will be seen as



small grains stained dark blue or nearly black in the chloroplasts of the mesophyll cells.

The structure of the *root* should also be examined: (1) Mount in water the roots of cress or mustard seedlings, and note the *root-cap* covering the tip of the root; the numerous long thin *root-hairs*, beginning a short distance behind the root-tip; the central cylinder of *vascular tissue*, and the *rootlets*, each arising from the central cylinder and breaking out through the soft outer tissue (*cortex*) to reach the surface. (2) Transverse sections should be made and examined from different parts of the root of a bean, to show the arrangement of the wood (*xylem*) and soft-bast (*phlœm*) bundles, on alternate radii, and the increase in vascular tissue in the older parts as the result of secondary thickening. In sections passing through the point of origin of a rootlet the latter will be seen to start from the vascular cylinder, immediately outside one of the xylem bundles—this explains the regular arrangement of the rootlets in longitudinal rows, as seen externally in the roots of seedlings like those of bean.

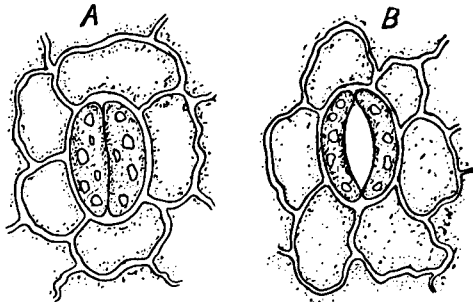

FIG. 252.—A, stomata closed; B, stomata open.

The *stem* (Figs. 253 and 254) serves primarily as a means for supporting and spreading out the leaves to light and air to the best advantage, besides bearing the flowers and acting as an intermediary between roots and leaves. In the young stem the *bundles* form a ring around the pith, so that the tissue of the stem is divided into an inner portion (*pith*), an outer portion (*cortex*), and a number of radiating lines known as *medullary rays*, extending from the pith, between the individual bundles; on the outside of the cortex is the epidermis, containing stomata. Each bundle consists of wood (*xylem*) on the inner side, and soft-bast (*phlœm*) on the outer side; a bundle of fibrous tissue (*hard-blast*) is often present on the outer side of the phlœm. The xylem vessels and the bast fibres show up clearly when sections of stem (or root) are treated with aniline solution, which stains them yellow, but leaves the other tissues (those with cellulose walls) unstained.

*Cambium.* Between the xylem and the phlœm there is an important tissue called the *cambium*, radial rows of thin-walled cells, containing abundant protoplasm. In dicotyledonous stems this tissue

is present from the beginning, but in the roots it is formed at a later stage, but in both it sooner or later becomes a continuous sheet, seen in cross-section as an outer ring, and its cells give rise to additional wood internally, and to additional bast externally, causing increasing thickness of the stem. The cambium is involved in various processes, such as pruning, grafting, propagation by cuttings, etc., owing to its power of producing fresh tissue.

**Root-Absorption; Essential Soil Substances.**—We have seen that the plant obtains a large part of its food from the air; but the substances absorbed from the soil are of the greatest importance, and

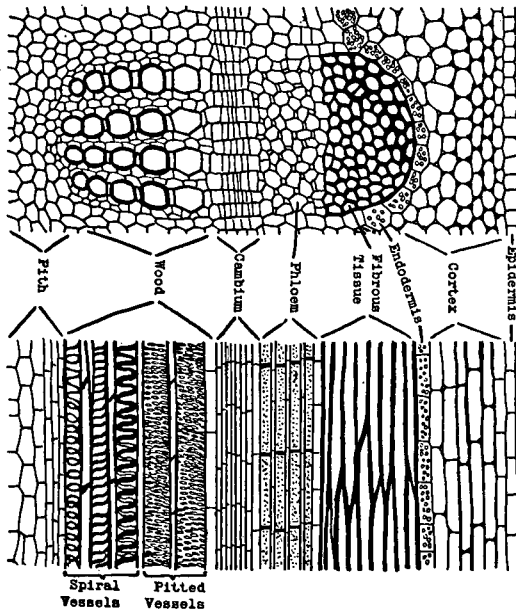

FIG. 253.—Partly diagrammatic transverse (upper) and longitudinal (lower) sections through a young dicotyledonous stem, showing the various tissues.

it is necessary to obtain a good grasp of the principles of root-absorption and of the conditions under which it is carried on. A soil must contain the same essential elements as a full culture solution, and these elements must be in a form available by the plant. Soil-water contains most of the essential elements in solution. The composition of the water present in a soil can be ascertained by analysis of drainage water; and can be tested for soluble matter by passing distilled water through them, and then applying to it tests for the essential ingredients.

**Chemical Processes in the Soil.**—Only substances in solution can be absorbed by the root-hairs. Substances ordinarily insoluble in pure water but required by plants are dissolved by various chemical processes which take place in the soil. Thus water containing carbon dioxide, which is always present in the soil, can dissolve carbonate of lime and various silicates. The acid secreted at the tips of the root-hairs acts as a solvent, and various soluble substances present in soil-water, by effecting chemical decomposition, bring intractable substances into soluble form.

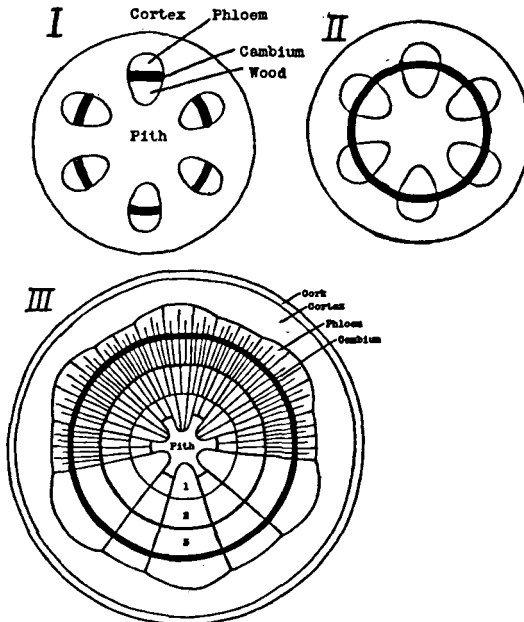

FIG. 254.—Diagrammatic cross-sections of a Dicotyledonous stem at different stages. In I the bundles of the young stem are distinct from each other, being separated by the broad primary medullary rays, which consist of ground tissue continuous with the similar tissue in the pith and in the cortex. In II the cambium has become a complete ring by the formation of strips of cambium (interfascicular cambium) in the rays, these strips being joined up to the cambium (fascicular cambium) in the bundles themselves. In III the completed cambium ring has given rise to secondary wood internally (showing three annual rings of growth) and to secondary phloem externally; the radial lines in the wood and phloem represent the medullary rays, and a layer of cork has been formed on the outside of the stem.

Soluble salts are largely washed out by drainage. The chlorides, sulphates, and carbonates are mostly removed in this way; but the soil keeps a firm hold of potassium and ammonium salts, and also of phosphates, as can be shown by allowing dilute solutions to filter

through the soil. The acids of ammonium and potassium salts are usually found combined with lime in the drainage water. The retentive power of soil for salts of potash, lime, phosphates, silicates, humates, etc., is partly due to chemical action between these substances and lime; partly to absorption by the porous and bulky humus, and partly to capillary upward movement in the solution occupying the minute pores between the soil particles.

The organic portion of the soil undergoes changes of great interest and importance, which have attracted more attention than the changes affecting the inorganic portion. The carbon in the organic matter of the soil is continually undergoing oxidation, carbon dioxide and organic acids being produced, and heat being evolved. The air in soil is always poorer in oxygen and richer in carbon dioxide than that above it. Organic acids make the soil "sour" and bad for plants, unless there is enough basic material (especially lime) to unite with and neutralize them. The nitrogen of the organic matter changes eventually into nitrates, and this change, which also occurs in the case of ammonia compounds, is called *nitrification*.

*Nitrification*, like most other changes that occur in organic matter in nature, is due to the action of micro-organisms (bacteria) (Fig. 4). Many of these have the power of converting the nitrogen of proteids into ammonia, which unites with the carbon dioxide produced, forming carbonate of ammonia, and this is oxidized (under the influence of certain bacteria) into nitrites, and finally into nitrates, ready for immediate absorption by roots. *Nitrification* can only occur under favourable conditions, the chief of these being: (1) suitable food for the microbes, such as lime, potash, sulphates, phosphates, and carbon dioxide; (2) basic material to combine with the nitric acid; (3) suitable temperature; (4) sufficient moisture; (5) sufficient oxygen; (6) absence of strong light, which paralyses and eventually kills the nitrifying bacteria.

*Nitrification* is arrested if too much ammonium carbonate is present, as may happen when too much farm-yard manure has been applied. This stoppage is prevented by the presence of gypsum (sulphate of lime), which converts the carbonate of ammonia into sulphate. A chemical change, involving the breaking up of nitrates and the setting free of nitrogen, takes place under certain conditions in soils and manure heaps. This *denitrification* is due to the action of certain aerobic bacteria, which can only do their work of destruction in (1) the absence of oxygen, and (2) in the presence of large amounts of easily oxidized organic matter in the soil.

*Nitrogen Fixation*.—A most important process set up by certain soil bacteria is the fixation of free atmospheric nitrogen, and the formation of nitric acid. According to observation, the nitrogen-fixing organisms can only work in the absence of oxygen, so that there must be other bacteria in order to help in removing the oxygen from the soil. As is well known, a fertile soil soon becomes exhausted of immediate plant food, especially of nitrogen, if successive crops are grown upon it; and the crops become gradually poorer until manures are supplied. The most important of all manures is nitrate of soda, and there is strong reason for

believing that the deposits of this substance, found chiefly in rainless districts of South America, have been produced by bacteria of the nitrogen-fixing kind. These deposits have doubtless accumulated during millions of years, the nitric acid produced by the bacteria combining with soda, present in the soil, and the soluble nitrate thus formed being preserved from loss by the extreme dryness of the climate. These valuable deposits are being rapidly used up, while the rate at which they are formed is very slow, and the conditions necessary for the production of thick beds of nitrate—e.g. a practically rainless area of desert—are found in few parts of the world. Nitrate of potash occurs in deposits in certain rainless regions of India.

Though the nitrogen-fixing bacteria occur everywhere in fertile soils, the nitrates produced are soon appropriated by plants, or

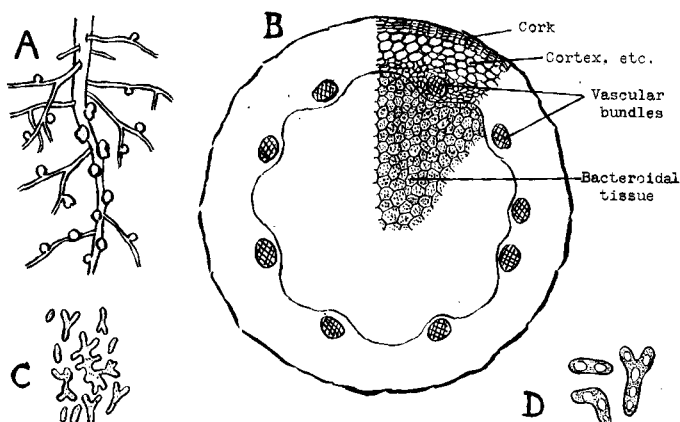

FIG. 255.—Bacterial Nodules of Leguminosæ. A, part of a broad bean root with nodules; B, diagrammatic cross-section of a nodule; C and D, involution forms (bacteroids) of the infesting organism from the bacteroidal tissue; C shows older and D younger stages in the development of the bacteroids.

washed out by rain-water. Long ago, Cavendish discovered that when an electric discharge is passed through air brown fumes of nitrous acid are produced—i.e. the oxygen of the air combines with the free nitrogen, and the resulting oxide, on being dissolved in water, yields nitrous and nitric acids. Cavendish added soda to the acid solution, and on evaporating the liquid obtained crystals of nitre; hence the name nitrogen or “nitre-former” (see nitrolime). A similar action takes place during thunderstorms, when nitrate of ammonia is formed in the air.

**Assimilation of Nitrogen by Leguminous Plants.**—The free nitrogen of the atmosphere is not usually made use of by the green plant. There is, however, at least one important order of flowering plants, the Leguminosæ, by which it is indirectly employed. It was for long recognized that leguminous plants will grow in soils

containing little or no combined nitrogen, and, as a matter of fact, that the soil was richer in nitrogen after the crop had been removed than previously. These facts, which were at first extremely puzzling, have now been explained.

Numerous small nodules or tubercles (Figs. 255 and 256) are found on the roots of leguminous plants. When these tubercles are examined they are found to be filled with small oval unicellular bodies called *bacteroids*. By some these are regarded as bacteria; by others as the "spores" of a fungus. They are always present in the soil and infect the roots of leguminous plants through the root-hairs. In these hairs they give rise to fine tubes which, making their way into the cortical tissue, stimulate it into active growth and thus lead to the formation of tubercles. The tubercles are rich in starch, and, later, each is invaded by a branch from the vascular bundles of the root. The bacteroids found in the fully grown tubercle are developed inside the invading tubes.

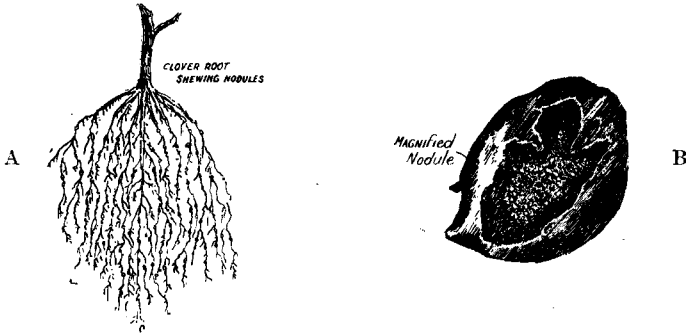

FIG. 256.—Bacterial Nodules. A, clover root showing nodules  
B, highly magnified nodule.

Analysis shows that the tubercles are very rich in nitrogenous substances, also in potash and phosphorus, and they seem to develop best in soils which are poor in nitrogen. They do not develop in plants grown in sterilized soil which has been heated so as to kill the organisms present in it. On the other hand, they develop on roots of plants which have been germinated in garden soil and then transferred into culture solutions.

There can be no doubt that we have here an example of symbiosis. The fungus apparently makes use of the free nitrogen of the air, and brings it into combination, just as certain true bacteria do; and it is probable that, while the leguminous plant receives the benefit of the nitrogen compounds (nitrates) formed, the fungus is supplied with carbo-hydrates (sugar) manufactured by the green plant.

**Available Plant Food in Soil.**—We have seen that root-hairs can only absorb dissolved substances. Salts insoluble in pure water, and required by plants, are brought into solution in various ways, chiefly by the carbon dioxide and by the changes due to the various chemical processes already mentioned. It is easy to show that

root-hairs give out acid sap, and carbon dioxide, which accounts partly, at any rate, for the acid reaction they exert on litmus. It also explains the eroding effects of root-fibres on slabs of marble.

A complete chemical analysis of a soil, though showing the amount of plant food it contains, often gives little practical information as to its fertility or its needs. It is necessary to know the amounts of the elements which are directly available for the use of plants. One method, used to determine the amount of phosphoric acid, for example, is to treat the soil with a 1 per cent solution of citric acid, as is further treated of in the section devoted to manures.

*Experiments.*—(1) Grow seedlings with their roots resting on wetted blue litmus paper, or dipping into blue litmus solution, and notice the change of colour, due to the acid substances excreted by the root-hairs.

(2) Grow seedlings in a layer of sawdust or soil resting on a slab of polished limestone. After a week or so, when the roots

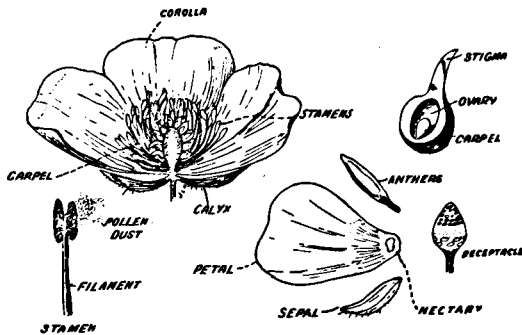

FIG. 257.—The parts of a Buttercup Flower.

have reached the slab, remove the latter and examine the surface closely for the tracks eaten into it by the roots.

(3) To show that roots give out carbon dioxide, it is only necessary to grow seedlings for a short time with their roots dipping into lime-water; set up a control experiment, with a jar containing lime-water, but no plant.

**Fertility of Soil.**—From what has been already said, it is easy to understand that the fertility of a soil depends on the existence of suitable relations between its (1) mechanical, (2) chemical, and (3) biological properties.

(1) No matter how rich a soil may be in plant food, it cannot reach a high degree of fertility unless it has the proper fineness of texture, porosity, water-holding power, and other physical properties which are essential for allowing the roots of plants to grow readily, and to be supplied with sufficient air and water.

(2) It is also essential that the soil should contain a suitable store of plant food in an available condition. However suitable the

structure of the soil, it cannot give the best results if the plant food (or any essential part of it) is present in insufficient amount, or in an insoluble or unavailable form.

(3) Since the conversion of one of the most important elements of plant food, nitrogen, from combination in complex and insoluble substances into the directly available nitrates is the work of certain bacteria, it is obvious that micro-organisms must be present in the soil in order to make it highly fertile.

**Selective Absorption by Roots.**—It is well known that on most soils it is better to change the kind of crop grown from year to year, instead of growing the same crop year after year. This is because different plants have different needs, and take their food ingredients in different proportions from the soil. For instance, cereals (wheat, rye, barley, oats) take from the soil less than half as much nitrogen, lime, and potash as "root-crops" (turnip, mangold, beet, potato). Hence crops with similar needs are raised alternately

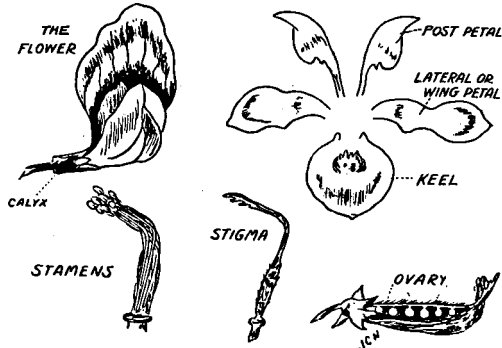

FIG. 258.—Flower of Pea.

instead of in succession, on the same field; this alternation constituting a "rotation of crops". When a plant is grown in a solution containing sodium nitrate, it takes up all the nitrogen and only a trace of the sodium, because more nitrogen is used by the plant than sodium (see Rotations).

**Reproduction of Flowering Plants.**—So far we have chiefly considered nutrition and growth, as essentials for the life of the individual plant. The race may be perpetuated in the case of many plants by purely vegetative means. Perennial plants which have branching underground stems, tubers, bulbs, and other organs in which food is stored during the winter multiply by means of these organs; for instance, the younger branches of a creeping stem, either above or below ground, may be set free by dividing the stock or by the dying away of the older parts. Similarly, tubers, bulbs, and corms become detached from the parent plant, and give rise to new plants.



In the case of annuals, the *production of seed* is essential for the perpetuation of the race, and even in the case of perennials the production of seed takes place sooner or later, though the necessity for seed production is here not so pressing. It is, however, in the long run quite as important. Apart from the fact that the seed forms the best possible method of propagation, reproduction by seed differs from other methods of increase in the fact that it involves the fusion of two *germ-cells* or *gametes* from different sources. Hence it is the most important method by which the race may be strengthened and useful variations transmitted from generation to generation.

There is no need here to describe the various types of inflorescence met with among the flowering phanerogams or plants, nor the various mechanisms by which flowers are naturally adapted for pollination by insects and the wind. The essential parts of a flower (Figs. 257, 258) are the *pollen grains* and the *ovules*, or

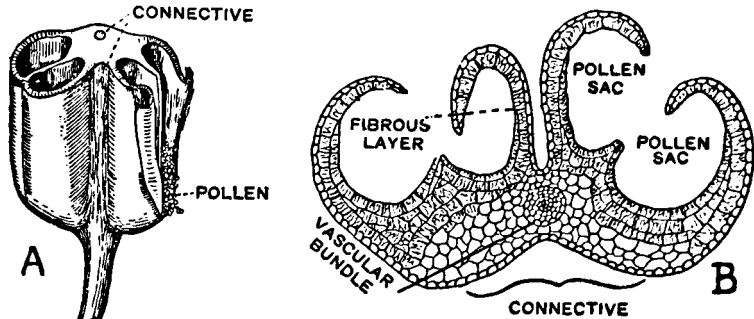

FIG. 259.—Structure of Anther. A, an anther cut across just after the pollen-sacs have opened to shed the pollen; B, cross-section of anther more highly magnified.

more strictly, the actual germ-cells, male and female, produced by these two elements respectively. In the majority of flowers the essential organs of reproduction (which may either be present in the same flower or in different flowers) are enclosed in an envelope (perianth) composed of free or united leaves; if the perianth is differentiated into two portions, the outer is termed the calyx (composed of sepals), and the inner the corolla (composed of petals).

The *anther* (Fig. 259) is usually borne on a stalk called the filament, the anther and filament together making up the stamen. The anther usually consists of four parallel chambers, the *pollen-sacs*, which contain the *pollen grains*; and when the latter are mature the anther opens to set them free, usually by means of a longitudinal slit on each side of the anther. The pollen grain is a single cell, containing when mature two nuclei, a vegetative nucleus, and a generative nucleus.

The *ovule* is usually egg-shaped and is attached by a stalk to the inner side of a closed chamber, the *ovary*, which is produced above

into an appendage, called the *stigma*, the surface of which is provided with receptive hairs. The ovary may contain one or many ovules, and the arrangement of the ovules in the ovary varies greatly in different flowers. A flower may contain a single ovary, or several ovaries; and when the ovary is single, it may either represent a single carpel or several fused carpels. A carpel may be defined as a modified leaf, the ovule-bearing portion of the carpel being closed so as to form the ovary, just as a stamen is a modified leaf-bearing pollen-sac.

When the ovule is mature it consists of a central mass of tissue (*nucellus*) covered by a single or double coat (*integument*), which remains open at one point to form the *micropyle*. Within the nucellus, usually nearer the micropyle end of the ovule, is the *embryo-sac*, containing a number of nuclei. The young embryo-sac

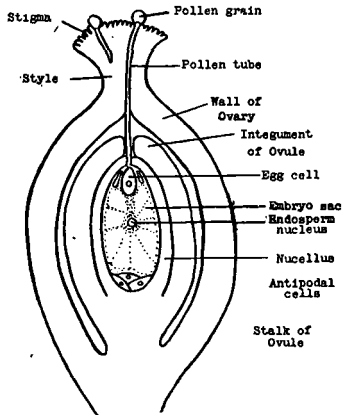

FIG. 260.—Diagrammatic longitudinal section of Ovary and Ovule of Buckwheat, showing a pollen tube which has reached the micropyle of the ovule.

has a single nucleus, which divides until eight nuclei are formed, four at either end—the two ends being distinguished as micropylar and antipodal. One nucleus from each polar group of four then moves to the centre of the sac, and these two nuclei fuse, forming the “secondary” or “fusion” nucleus. The three nuclei at the antipodal end are then cut off by cell-walls and need not be considered further, while of the three nuclei at the micropylar end one (*oosphere*, or female germ-cell) becomes larger than the other two (*synergids*, or “help-cells”).

When, by the agency of wind or an insect, a pollen grain is brought within the receptive tissue of the stigma, it germinates, sending into the tissue of the stigma a slender tube, resembling a root-hair, and into this *pollen tube* pass the nuclei of the pollen

grain (Fig. 260). This tube burrows through the stigma and style until it reaches an ovule; meanwhile the generative nucleus has divided into two, hence the tube contains three nuclei. When the tube enters the micropyle of the ovule, it discharges, probably by absorbing the sap from the synergids, and its three nuclei pass into the embryo-sac. One of the generative nuclei fuses with the oosphere, the other with the "secondary" nucleus (fused polar nuclei) at the centre of the sac. Hence fertilization is a double process, involving fusion between two pairs of nuclei.

The fertilized oosphere then develops into the *embryo-plant*, while the fertilized "secondary" nucleus gives rise to a mass of tissue, known as the *endosperm*. In some cases the endosperm either shows little development or is absorbed by the growing embryo, before the growth of the ovule into a seed is completed—in such cases the seed is non-endospermic or exalbuminous. In other cases the endosperm grows actively, so that the mature seed contains a more or less prominent mass of tissue in addition to the embryo—such seeds are endospermic or albuminous. In any case, during the development of the seed, various food materials, brought from the leaves, are stored up in the endosperm or in the embryo itself, and finally the seed undergoes drying and is ready to be set free in its resting condition. It is unnecessary to describe the various methods by which the seeds are dispersed, although they are both numerous and interesting.

#### HEREDITY AND VARIATION.

The actual process of fertilization in plants—which in the case of flowering plants leads to the formation of the seed—is precisely the same as in animals. It consists in the fusion of two nuclei, one from each parent—in flowering plants the pollen or male element and the ovule or female element. Even where an individual plant has been produced directly from cuttings—as well as in certain exceptional cases where a seed is formed without pollination and fertilization, every nucleus of the individual consists half of nuclear matter, derived from the male parent and half from the female parent. The nucleus is the carrier of that mysterious potentiality which we call heredity—that is, the transmission of the characteristics of the parents to the offspring.

But while the offspring of parents show a general resemblance, they also show considerable differences upon close inspection and measurement; indeed, no two individuals are precisely alike. The capacity for variation is universal among living organisms, for all individual characteristics of all ancestors are not transmitted to the offspring, but every organism shows modification and possesses an individuality of its own. This modification reflects external conditions, or it may appear in response to changes in the environment; it may be an acquired character shown merely during the life of the organism, or it may be an innate and transmissible characteristic.

Individuals which resemble one another closely, owing to their having had a common parentage, may collectively form what is called

a race, a species, or a variety. Our estimate of the value of such groupings is based on the study of individuals, and centre around average examples; but certain extremes may appear among multitudinous slight variations, and some of these extremes may insensibly shade off into other varieties, or they may even stand apart owing to having sharply defined characters. In any case, a group of individuals—whether termed a race, variety, or species—is to a large extent a theoretical average with regard to character, and consists of a series of individuals showing minor variations arranged around an average type. If many individuals are examined with regard to any one character, the result may be set out in the form of a variation curve. In most cases the curve is normal or symmetrical, showing the highest frequency, or average (or “mode”), in the centre, corresponding with the “law of probability” or “curve of frequency of error”. Sometimes the “mode” is displaced to one side, giving an unsymmetrical or skew curve.

**Variation.**—Ever since man cultivated or domesticated plants and animals he has selected, isolated, and bred the most desirable forms, excluding or destroying those he considered undesirable. By this process new breeds or races have been obtained. Darwin saw that in nature similar processes have given similar results, and his theory of Natural Selection was based upon these facts.

By the artificial selection of fluctuating variations it has been found possible to make great improvements or to maintain a standard. But, on the other hand, there are many observers who deny permanence to these fluctuating characters, on the ground that they often are due to the environment, to nutrition, and so on, and that there is no satisfactory evidence that they can be worked up and fixed as specific permanent characters—in other words, that the small fluctuating variations are not the basis upon which selection works, and that the *heredity of fluctuations* is an extremely difficult and slow process, and its results of questionable permanency.

**Mutation.**—There is, in fact, a great diversity of opinion regarding the magnitude of the variations, by means of which progress in selection, whether natural or artificial, is maintained, and much experimental work is in progress with the object of throwing light upon the questions involved. The work of Professor Jahannsen suggests that while the average for the race or species can be moved in one direction or another by pure line breeding, it can only be so moved very slowly, and that the tendency to retrogression towards the average will tend to break up a “mixed population” (resulting from crossed and miscellaneous breeding) into distinct pure lines; that is, each form-type tends to be constant, and new types must arise chiefly through mutations or else through hybridization.

Professor de Vries advanced the view that all evolutionary progress is based upon the occurrence of mutations. A mutation is a variation which appears suddenly and which is fully transmissible. As contrasted with fluctuating variations, mutations are termed discontinuous variations. According to de Vries, the selection of fluctuating variations cannot lead to permanent progress, because these variations are only “linear” and thus cannot afford a basis or handle for the

origin of new forms. In other words, by fluctuating variation already existing bodies, organs, and parts can be enlarged or made smaller, greener, or less green, and so on—that is, developed “plus-ward” or “minus-ward”—but by this nothing new arises, and the differentiation of organs consists, on the whole, in the evolution of actually new characters, i.e. jumps.

A mutation may be relatively large or relatively small, while variation only involves a single unit character or a group of unit characters. It is often larger than a fluctuation, but may be smaller; in fact, very careful analysis is often necessary before anyone can distinguish between a fluctuation and a small mutation, and much more work is required before it will be possible to estimate properly the respective value in evolution of mutation and fluctuation, or to what extent mutation is transmissible, and, in general terms, the extent and frequency and behaviour of mutants or forms arising through mutation.

Mutation is apparently of great importance in connexion with crop improvement, since it directs attention to unusual individuals and types (rare and marked “sports”) and to the possibility of securing permanent and immediate improvement by the isolation and breeding from such forms.

**Genetics and Breeding.**—The embryo, with its hereditary possibilities, derived from ages of ancestors, and determining the specific or racial type of the plant, is surrounded by an *environment* which is a complex of physical and chemical factors, determining the growth of the individual. Heredity and environment are closely linked, since environment moulds heredity, while heredity affects the mode of response to environment. The study of the transmission through successive generations of racial and individual characters is termed Genetics, and this finds direct practical application in the practice of breeding.

A plant, or animal, arises from the union of two germs or gametes. In a flowering plant these are (1) a nucleus, with very little or no accompanying protoplasm from the pollen tube, and (2) the egg-cell in the ovule. The resulting organism thus unites two lines of ancestry, and it will resemble neither parent exactly, nor will it as a rule be exactly intermediate between the two—especially when the parents show strongly contrasting characters. It may show distinctive characters of both parents, or perhaps some characters derived from more distant ancestors, along with others which may appear as modifications, or which may be apparently new. There are various distinct types of hybrid inheritance—blended, intensified, mosaic, heterogeneous, alternative, etc. According to Galton's law of ancestral heredity, assuming unity as the total heredity possession of the individual, values diminish in a geometrical series averaging thus:—parents, one-half each; grandparents, one-fourth; great-grandparents, one-eighth; and so on.

**Mendelism.**—Such generalizations as Galton's are, of course, merely the expression of the observed results of complex hereditary influences through several generations; they give little or no indication of any particular method in hereditary, and no analysis of the

independent characters concerned. For instance, as a matter of fact, some ancestors may contribute only a few characters, or even apparently nothing distinctive.

The newer studies in heredity began with the twentieth century, with the rediscovery of work done nearly fifty years earlier. This work is concerned mainly with alternative inheritance in hybrids—that is, inheritance in which the crossing of forms distinct with regard to any particular character, yield offspring which may resemble one parent only. The fundamental questions with which this work deals may be illustrated by giving an instance of the simplest form of the problem. If bearded wheat is crossed with beardless: Will the progeny be bearded or beardless, or intermediate, and what will happen in succeeding generations? This line of investigation was first developed by Gregor Mendel, whose work was published in 1865, after ten years of research, and was practically lost sight of until rediscovered in 1900.

Mendel found, by careful breeding experiments made with plants of the same species, but chosen from distinct horticultural varieties, that a certain characteristic of one parent made its appearance in all the offspring resulting from the cross, to the exclusion of the corresponding character of the other parent. He worked chiefly with the garden pea, which formed excellent material for his purpose. He required material with marked contrasting characters, the hybrid offspring being easily protected from foreign pollen, and the offspring being unaffected, as regards fertility, by the inbreeding processes necessary in the experiment.

After testing for two years the constancy of thirty-four varieties of pea, he chose those which showed well-defined contrasting characters, and dealt with large numbers in order to avoid individual errors as far as possible. Three of his seven contrasting character-pairs in the case of the pea comprised (1) yellow and green colour of cotyledons, (2) white and coloured seed-coat, (3) tall and dwarf stature of plant. When a tall variety was crossed with a dwarf variety, all the offspring were tall. When the tall plants *thus* obtained were bred together, the offspring were either tall or short, in the proportion of three tall to one dwarf. Inbreeding was continued, and in the third generation all the offspring of the dwarf peas resembled their immediate parents, while only one-third of the tall plants bred true, the remaining two-thirds giving rise to tall and dwarf individuals which (like the offspring of all the tall plants that resulted from the first cross) were in the proportion of three to one.

Exactly the same rule held good for the other six character-pairs. The character which appeared in the hybrid of the first generation (termed the  $F_1$  generation, or first filial generation) was termed the dominant of the pair, and that character which was masked or latent in the  $F_1$  generation was termed the recessive. In the other two cases mentioned the dominant characters were yellow colour of cotyledons and coloured seed-coat.

In each case one-fourth of the individuals of the  $F_2$  generation showing the recessive character breed true in all subsequent generations ( $F_3$ ,  $F_4$ , and so on). Similarly, one-fourth of the total number

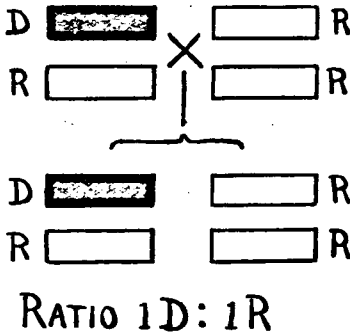
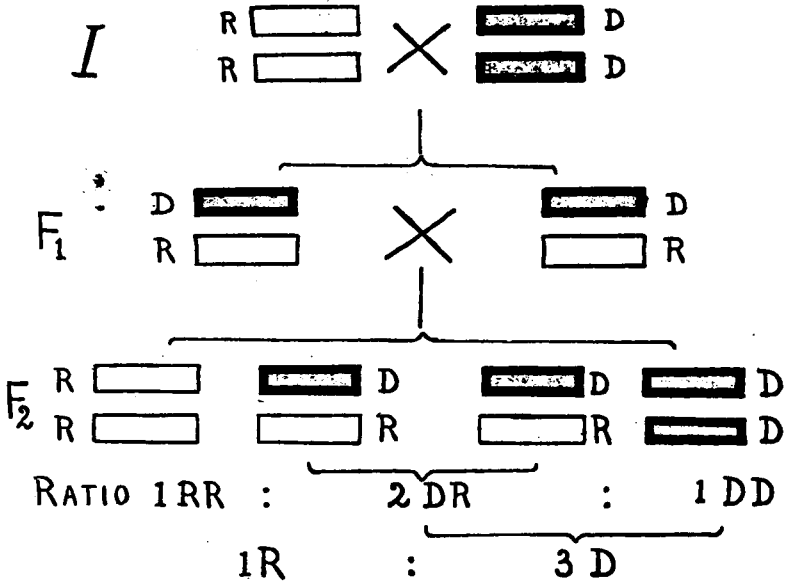

II

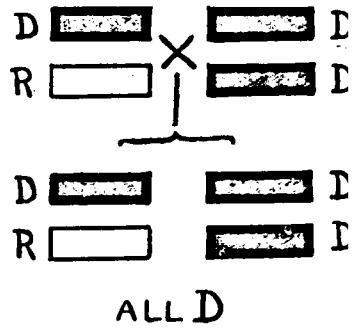

III

FIG. 261.—Diagrams showing the numerical consequences of Mendelian segregation. The three diagrams illustrate the four simple types of Mendelian families, which are as follows: DD × RR gives all DR; DR × RR gives 1 DR : 1 RR; DR × DD gives 1 DD : 1 DR; DR × DR gives 1 DD : 2 DR : 1 RR (appearing as three dominants : one recessive). Diagram I shows the mating DD × RR, and DR × DR. Diagram II shows the mating DR × RR. Diagram III shows the mating DR × DD.

of  $F_2$  individuals (one-third of the apparent dominants) breed true as dominants. The remainder (one-half) of these are hybrid or impure dominants, and break up in the  $F_3$  generation exactly as did the whole number in the  $F_2$  generation. This was repeated through successive generations. Hence the  $F_2$  generation may be represented thus:  $D$  plus 2  $D$  ( $R$ ) plus  $R$ , in which  $D$  represents dominants,  $R$  recessives, and  $D$  ( $R$ ) hybrid, or impure dominants, in which only the dominant character is evident. The impure dominants are here indistinguishable from pure dominants, but they show segregation in the next generation.

Recent work has resulted in the compiling of a long and ever-increasing list of characters in both plants and animals which behave in this way, and which are therefore termed allelomorphic or Mendelian characters. Whether or not a character is Mendelian can only be decided by actual experiment; in familiar language we must not judge individuals by their appearance, but by what they produce. In the breeding of plants and animals which differ markedly from one another in a number of respects, looked-for characters may not appear in the hybrids themselves, but may crop up in the second generation, when the hybrids breed among themselves; and this is an important practical point, for in the past there has often been a tendency to give up work after a single apparently unsuccessful experiment. Either sex has little effect, for when the reciprocal cross is made by using the male parent of the first experiment as female parent in the second, like hybrids may result—in Mendel's experiments with a single character-pair the results were the same whichever parent furnished the pollen.

Omitting the more complicated cases of Mendelian inheritance and breeding, mention may be made of the interpretation which Mendel himself placed on his results in his theory of the purity of the gametes. It is clear that, in the case of the hybrid between a tall ( $T$ ) and a dwarf or short ( $S$ ) pea, the male gametes in equal number will carry the characteristic tallness or dwarfness, but never both, and similarly with the egg-cells or female gametes. Assuming large numbers, these gametes on uniting, by the laws of chance (i.e. without selective fertilization), would yield the following four kinds of offspring: tall with tall or  $TT$  (homozygote tall); tall with dwarf or  $T$  ( $S$ ) (heterozygote), dwarf with tall or  $S$  ( $T$ ) (heterozygote), dwarf with dwarf or  $SS$  (homozygote dwarf). From which we get  $T$  plus 2  $T$  ( $S$ ) plus  $S$ .

The essential features of Mendelism are dominance and segregation, and it has been shown that many Mendelian character-pairs (allelomorphs) may be expressed by the presence or absence of a single character instead of by two contrasting characters, either presence or absence being dominant. On the principle of the purity of the gametes, and their combination according to the laws of chance, it becomes a simple mathematical problem to determine the number of combinations resulting from a cross in which two or more character-pairs are involved (Fig. 261).

The material basis underlying Mendelian inheritance—the behaviour of the chromosomes of the nucleus—need not be discussed



here, nor the more intricate cases which have been unravelled by the application of the Mendelian method to the analysis of the characters which make up the individual. It is clear, however, that a knowledge of Mendelism necessitates considerable modification both as to the older views of heredity and in the methods of selecting hybrid offspring. In alternative or Mendelian inheritance there can be no selection in the  $F_1$  generation, but in the  $F_2$  generation selection for the pure recessives may be made. Since homozygous dominants are usually distinguished from heterozygous dominants only by the absence of segregation in subsequent generations, it is necessary to isolate individuals and to test these by breeding. Clearly, when several character-pairs are involved, each of which requires consideration, selection with respect to dominant or recessive characters becomes a complex and laborious matter (see also remarks on the same subject in the section on breeding live stock):

## CHAPTER II.

### HARDY FRUITS, FLOWERS, AND SOIL PREPARATION.

No farmer can afford to disregard the cultivation of hardy fruits, as it not infrequently happens that fruit-trees or bush fruits prove quite as profitable as do other cultures on the farm, especially in the vicinity of large towns. Success will also largely depend upon the soil and climatic conditions, coupled with the knowledge and skill of the cultivator.

The principal hardy (not hard) fruits adaptable for cultivation on ordinary farms are apples, pears, plums, cherries, gooseberries, raspberries, and strawberries. While a farmer cannot be expected to become an expert in fruit cultivation, he can nevertheless gain a very thorough knowledge of how to produce average yields of those fruits suited to his district, and when harvested to put them on the market to the best advantage.

**Soil and Situation.**—The different kinds and species of fruit vary greatly as to their soil requirements, to overcome which difficulty grafting or budding is often resorted to. If the soil is shallow a stock is used whose roots possess a natural tendency to spread horizontally near to and below the surface of the soil, finally assuming a fibrous character. A deep, loamy soil inclined to be calcareous, and neither too dry nor too wet will suit the majority of fruit-trees, but rarely are such ideal conditions met with.

The site on which to plant fruit-trees must be carefully selected. Steep slopes and dry tracts of land are never productive of strong vigorous trees, neither should the ground be low-lying and highly charged with moisture, as is often the case along river-valleys, as in addition to a cold and waterlogged condition of the soil, fogs are prevalent and hoar frosts are liable to prove fatal to fruits which mature early. It is useless to attempt the cultivation of pears in localities of this kind, as the flower-buds are usually destroyed by May frosts. If the ground has a gradual slope towards the east or south, so as to face the sun at about 11 o'clock, it is preferable, as during frosty weather the frozen plant has a better chance of thawing before the more direct rays of the sun fall upon it; and which would otherwise, owing to the too sudden contraction of the cell-walls, cause rupturing to take place, followed by the premature death of the affected parts.

The student must distinguish between the cultivation of fruit for pleasure, or merely for obtaining fruit regardless of cost, and commercial fruit culture. In private gardens where the soil is not naturally suitable for fruit culture it should be replaced, or improved,

by adding specially prepared composts to it—a very expensive procedure, and one which is generally outside the province of the market grower.

**Shelter.**—Shelter is of extreme importance where the more tender varieties of fruits are being grown. In using the word shelter it need not be inferred that a plantation of fruit-trees must be closed in on all sides, or even on one side; all that is necessary is that the growth of both young and old trees should be protected from sudden checks, and from the impact of cold winds from the north, north-east, and north-west. A screen or “wind break” is best effected by planting a belt of quick-growing trees such as poplars along the north

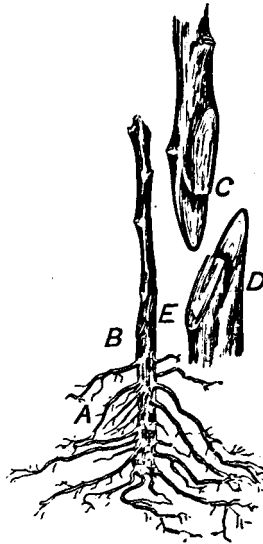

FIG. 262.—Grafting. *A*, root or stock of quince as raised from cutting; *E*, method of heading back or cutting stock, showing tongue or notch; *D*, corresponding tongue in scion; *B*, appearance of stock and scion when in position.

side, some 60 or 100 feet distant from the plantation; this belt may then turn at the north-east and north-west corners at the same distance away, then gradually widen out to the south-east and south-west, with a free exposure to the south. If the position of the orchard or fruit garden possesses natural shelter from cold winds, so much the better, as bad results often follow through allowing screens, or belts of trees, to become too tall, especially if planted close to the plantation. Fruit-trees of all kinds revel in an abundance of air and sunshine, and the more open and exposed they are, without being subjected to treacherous winds, the better.

The Propagation of Fruit-trees is effected in many ways, but this work is best left in the hands of skilled nurserymen, as the large number of worthless and unsightly trees to be found in gardens can be traced to amateurs of an experimental turn of mind, but lacking practical knowledge.

Apples may be grown on their own roots, or grafted on either crab or Paradise stocks. Pears, if grown on their own roots, take many years to come into bearing, whereas if grafted on a fibrous-rooted stock, like the quince, the habit of the tree is altered; it remains comparatively dwarf, matures early, and therefore bears fruit at an

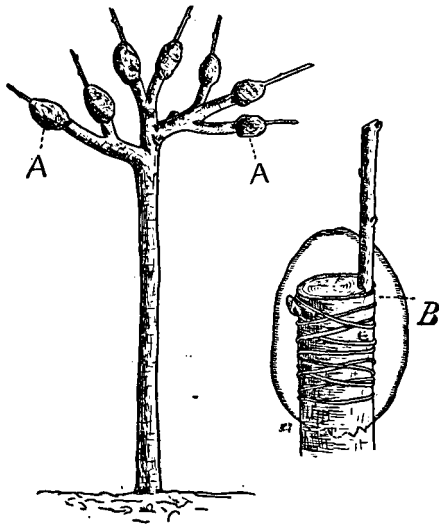

FIG. 263.—Standard apple headed or cut back early in the year in readiness for grafting in March or April; a common practice where a particular variety does not succeed. Crown grafting as shown at *A* is resorted to, and in some cases two or even three grafts are inserted, but when the branches are numerous and the stock young and healthy one graft to each limb is usually sufficient. *B*, showing method of inserting graft and covering with clay or grafting wax.

early age. Those varieties of apples and pears, which when grown on their own roots make a weak growth, are better grafted on more vigorous rooting stocks like the crab, and pear; while those possessed of strong root action should be grafted on the more fibrous rooting stocks, in order to check their exuberance and so bring them sooner into bearing.

Stone fruit, like plums or cherries, are usually budded in preference to being grafted, as a better union is effected with less serious check to the plant. The choicer varieties of plums should be budded

upon the stocks of Mussel plum, Myrobella, and others, while cherries are usually budded on stocks of the wild cherry; stocks in both cases being raised from seeds sown in the spring or autumn. Stocks on which apples are grafted are usually raised from seed, as are also pear stocks, but quince stocks are more readily obtained from cuttings inserted in the soil during autumn, when, if the soil is warm and moist, they will be sufficiently well rooted to carry grafts in the following spring. Grafting is best performed in March or early April before the sap is elaborated throughout the branches, and to check this tendency in the case of larger stocks it is necessary to head or cut them back in January or February.



FIG. 264.—Budding. *B*, *B*, stem of rose showing prominent dormant buds suitable for budding; *C*, bud with surplus wood removed; *D*, under-surface of same, showing base of bud *E*; *F*, position of bud after insertion; *G*, method of securing bud in position; *H*, method of making incision in bark of stock; *K*, bark gently prised open.

Budding is most successfully performed in July when the sap is flowing freely, and has attained some consistency. Students cannot become efficient in any of the above operations without practical experience, but some idea of the methods of procedure will be found on making reference to Figs. 262, 263, and 264.

Bush Fruits, or as they are often called, "soft" fruits, are easily grown, provided the climate and soil are suitable. Gooseberries revel in a humid atmosphere and a soil that is fairly retentive of moisture. In the south-west of Scotland, and along the west coast of England, gooseberries flourish to perfection. Lancashire has for generations been associated with the production of the finest qualities of

gooseberries, individual berries from plants given special treatment, having attained 2 oz. in weight.

Black currants grow freely in any moist soil, provided no stagnation is present; in fact, there is no position to equal the banks of a stream, where the soil is characterized as alluvial; they prefer partial shade to a position open to the sun. Red and white currants succeed in any ordinary garden soil, provided it is well exposed to the sun, and is not too dry, or parched in spring or early summer. Both red and black currants are readily propagated from cuttings of the

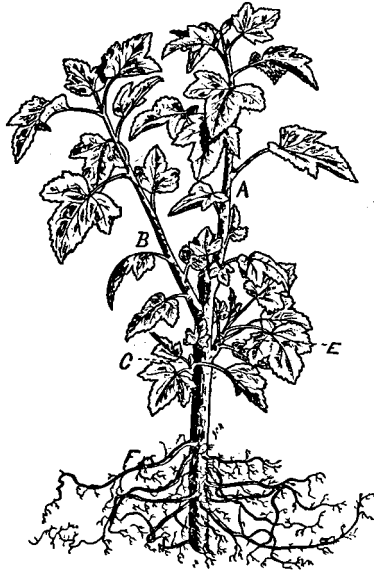

FIG. 265.—Cutting of Red Currant, showing development of dormant buds in spring. *A*, strong growth made by terminal bud; *B*, almost equally strong growth made by second bud from apex; *C* and *E*, remaining buds, which have only had just sufficient strength to push forth a few leaves. These latter buds may extend in length when the two leaders are headed back at the winter pruning, but they very often bear fruit and remain stunted; *F*, a mass of roots produced during the autumn and spring following insertion of the cutting.

same season's growth, removed in autumn, with a heel of the previous year's wood attached, and inserted in rows 1 foot apart and 6 inches from cutting to cutting in the rows. As both red and white currants are grown upon a "leg", or clean stem above the ground (Fig. 265), the lower buds must be removed from the cutting before insertion in the ground, leaving only three or four buds at the apex, after having first removed the terminal bud. In black currants young wood is encouraged from the base of the plant under ground, to

supply which it is necessary to leave on the basal buds of the cuttings, which later give rise to suckers.

**Strawberry Growing** may be regarded as an industry especially restricted to fruit-growing counties such as Kent and Hampshire. Certain tracts of soil in the latter county are favourable to the production of early crops, which reach the market before the Kent supplies, or even earlier than those from market gardening centres like Evesham. It is these early crops that pay the grower, but, as is the case with all land possessed of special advantages, the rent is proportionately high, and in many cases commands as much as £5 per acre.

Rich, heavy loams, or clayey soils, are practically useless for strawberry growing, as the plants produce foliage at the expense of fruit, and even should there be a fair show, the fruit is liable to become mildewed and useless, owing to the continuous shade and moisture to which it is subjected. New varieties of strawberries, like most other fruits, are produced by hybridization, and therefore from seeds, but this method of reproduction does not concern the grower, who each year, after the fruit is gathered, must peg down an ample supply of runners wherewith to make a new plantation. Should he prefer to purchase runners from other growers, he can do so at a cost of from 3s. 6d. to 5s. per 1,000.

Strawberries grow freely on gravelly soils, provided there is a sufficiency of moisture, the plants being prolific without an over-abundance of foliage. In field culture, the plants are sometimes set out in squares, allowing room for the horse-hoe to pass between the rows and the plants in the rows, thus economizing labour.

**Raspberry Cultivation**, like that of the strawberry, is largely restricted to those districts in which the fruit is known to flourish with a minimum cost of labour. The soil must be deep and moist, and if cool throughout the hot days of summer, so much the better. Strong healthy canes are never produced on badly drained soils, or on those of a hot and dry nature.

The fruit is borne on the young canes of the preceding year's growth; therefore it is essential that every inducement should be given to the wood to become thoroughly ripened during the autumn, by cutting away all old canes immediately the fruit is gathered, and thereby admitting as much light and air as possible (Fig. 266).

Autumn is the best time for planting or making new plantations; and in selecting suckers, or young canes, for this purpose preference must be given to those that have an abundance of fibrous roots attached, instead of short canes with little or no root stock. They should be planted in rows 5 feet apart, with the canes 12 to 24 inches apart, according to soil and variety. After planting, cut the canes back to within from 6 to 12 inches of the ground, according to their strength, the weaker ones being cut almost to the ground. In the following year it will be necessary to support the plants by means of stout stakes or wire strained to posts, at each end of the rows.

**Blackberries and Allied Fruits** now command the attention of the market grower, and the logan-berry may be cited as an example of a fruit which has during late years sprung into favour, and is

preferred by many to the raspberry, for dessert and culinary purposes.

Blackberries require abundance of room, as when given a heavy retentive soil they develop shoots of considerable length. It is important that these shoots should become thoroughly matured and ripened in autumn, and, as advised in the case of the raspberry, old fruiting wood should be removed. The ends of long branches should be shortened back, and those remaining tied to suitable supports to enable them to resist the rocking action of the wind.

**Manuring Fruit-trees.** — Fruit-bearing trees require careful manuring, and no definite rules can be laid down as to how and when



FIG. 266.—Raspberry, showing old fruiting canes, *A, A*, together with young canes, *B, B*, upon which the next season's fruit will be borne. As soon as the fruiting season is over the fruiting canes must be cut out close to the ground as indicated by horizontal lines; this allows of the young soft wood becoming matured by admitting air and sunshine.

any particular tree or group of trees should be manured. Each tree must be dealt with individually, except in plantations of the same variety and age, and to all appearance equally prolific as regards fruit production.

Young trees, if carefully planted from nursery rows, and well grown before being removed to their permanent quarters, will continue to make wood very freely; thus it is evident that no further stimulation to growth is necessary. It is the greatest mistake imaginable to manure young trees at the time of planting, by



incorporating heavy dressings of farm-yard manure with the soil, or applying manures of a more concentrated character. In some cases the growth of young trees is retarded by the injudicious application of manure, while in others the roots are stimulated into excessive activity, with the result that at a later date, usually the second or third year after planting, it becomes necessary to lift the trees bodily from the ground and sever the stronger roots by the aid of a saw or knife, in order to check superfluous wood-growth, and so induce the formation of fruiting spurs along the extension of the branches.

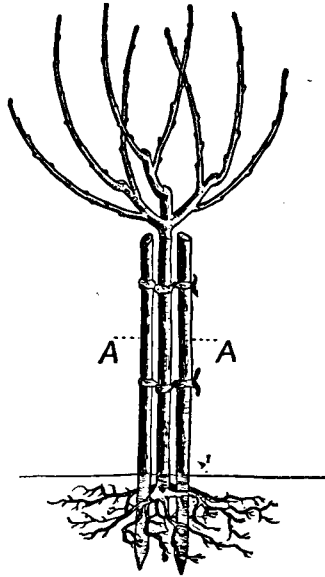

FIG. 267.—Appearance of young Standard Tree, showing pruning of the branches the second year after grafting. A. A. two or three stakes should be used to keep the tree in position and to prevent its being rocked about by the wind.

The correct time to manure a fruit-tree is when it shows signs of exhaustion, due to excessive productiveness. If bushes, cordons, or espaliers are lifted when young, and their roots are carefully attended to, and, if necessary, new soil added, they are induced to make abundance of fibrous roots which facilitate feeding upon readily soluble manures. On the other hand, very little good can be effected by the surface-manuring of trees, the roots of which have penetrated deeply into the ground, and are lacking in secondary or fibrous roots. The disadvantage of placing layers of farm-yard manure around the base of the tree is, that its presence tends to facilitate the breeding

of numerous injurious insect pests, and may also to some extent encourage the dissemination of fungoid diseases.

Experience, assisted by careful and long experimenting, will alone produce efficiency in manuring. In the manuring of bush apples as much as 8 cwt. of nitrate of soda, 15 cwt. of basic slag, and 5 cwt. of sulphate of potash per acre may be used with advantage, while in the case of specially cultivated trees, these figures would be largely exceeded. All plantations of young trees should be given

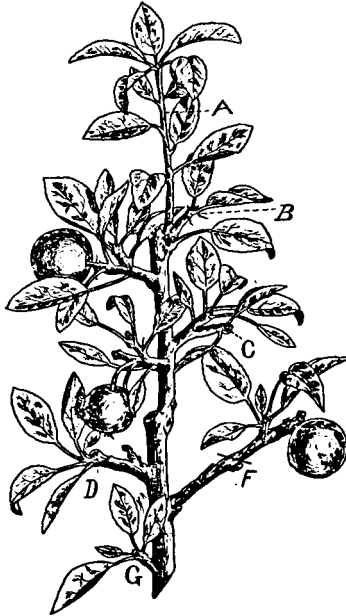

FIG. 268.—Typical Fruiting Branch of young Apple. The leader *A* is being partially stunted by a basal fruit spur *B*, also by the general prolific condition of the whole branch. Where branches have developed to their full length, then no better condition could exist than that shown in the diagram. *C*, fruit spurs; *D*, fruit scars; *E*, long spur requiring shortening at *F*; *G*, fruit bud.

a manurial dressing each year, a slowly soluble manure like basic slag being sown in December, sulphate of potash in February, and nitrate of soda early in April. If other manures are substituted to supply nitrogen, phosphates, or potash, they must be sown in keeping with their solubility. An additional dressing of soluble manure may be given as soon as the fruits are set; as when heavy dressings are given before the success of the crop is assured, harm instead of good may follow, to say nothing of financial loss. These

remarks apply only to well-managed plantations containing choice fruits, or where the ground under the trees is kept free from weeds by periodical hoeings.

The Planting of Fruit-trees is an operation deserving of the greatest care, as carelessly planted trees may take years to recover. November is the best month for planting, as the atmosphere is charged with moisture, and little evaporation takes place from the leaves, or from the delicate roots of the trees which are exposed to the air. Of even more importance is the fact that the ground has not yet lost its warmth, therefore young roots are developed before winter. Much planting of hardy fruits and other deciduous trees is performed as late as February and March, but it stands to reason that if the trees have been exposed, as they often are, to a drying atmosphere, in transit from the nursery, they cannot well recover themselves when placed in a cold soil; while if a spring drought sets in in April or May, there is a very grave risk of their dying before new roots are formed.



FIG. 269.—In order to convert a strong wood growth into a fruiting spur it is necessary to check the flow of sap by twisting the extremity of the shoot as at *A*. This will have the effect of stimulating lateral buds into growth as in *B*. Other laterals will make their appearance towards the end of the season. The whole object is to weaken the shoot and so induce the formation of fruit buds. At the winter pruning the shoots will be shortened or spurred back as shown in *C*.

Trees intended for planting should be carefully selected in the nursery, in order that they may be free from insect pests and fungoid diseases, as when trees become infected with a pest such as American blight or woolly aphis they are not easily cleaned.

If the weather conditions are such as do not admit of the trees being planted when received, the bundles must be immediately opened and the trees laid in an open trench in such a way as to admit of the roots being well covered with soil. Planting must never be performed when the soil is wet, or shows liability to knead like dough. Neither is it advisable to attempt planting during frosty weather, or when the soil is still frozen.

Previous to planting, the roots should be carefully examined, and all jagged, or damaged, portions removed with a sharp knife. In planting large areas, or numbers of trees of the same size, it is preferable to prepare the holes beforehand; these must be wide enough to contain the roots comfortably, and deep enough to cover

them. There is no greater mistake than that of planting *directly* on the surface, and placing a mound of soil over the roots. The roots should be laid out as horizontally as possible; the soil worked into the crevices by slightly rocking the tree backwards and forwards, and when the greater part of the soil has been returned, the whole must be firmly trodden down with the feet, and, if the soil is comparatively dry, too much pressure cannot be used. In the case of standard trees, staking is necessary, and is best performed before the soil is filled in, as the driving of one or more stakes into the ground after the soil is replaced may be attended with considerable damage to one or more prominent roots. The method of planting a standard tree is shown in Fig. 267.

FIG. 270.—Branch of Apple. When it is desired to furnish a branch with fruiting spurs along its entire length, sufficient of the season's growth must be removed to ensure the development of what would otherwise be dormant buds were the whole or greater portion of the growth allowed to remain. Usually about two-thirds of the current year's growth is removed. From A to B represents two years' growth. To obtain another or third length of stem remove the portion from D to E, and so on each successive year until the required length is attained, when the branch can be kept pruned back to a fruit bud or spur. F, F, scars remaining after removal of shoots at winter pruning. C, C, fruit buds.

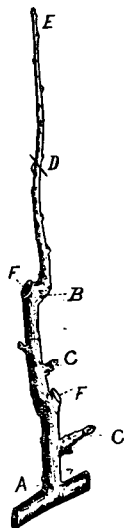

**Pruning.**—Many promising young trees are often completely ruined through injudicious pruning. The principal object of pruning is to produce healthy, well-developed, and shapely trees, of as productive a character as possible.

The extent to which any tree is pruned, and the system of pruning adopted, depends upon the variety of fruit, and the constitution of the individual tree, as varieties of the same species often require different treatment. For example, some pears fruit on long spurs, and some on short spurs, and the same applies to certain varieties of apples. Therefore, to shorten back these long spurs at the winter pruning would be to deprive the tree of its natural means of fruiting. With but few exceptions, apples, pears, and plums fruit on short branches, or spurs, as shown in Fig. 268. To encourage the formation of these lateral spurs young vigorous wood-growths are benefited by

having their extremities twisted, pinched, or stopped during summer, preferably in the months of June or July, and finally cut hard back in winter (Fig. 269). Winter pruning is best done from December to February, when, in addition to pruning proper, it is essential to remove all dead and decaying branches, and those that tend to exclude light and air from the centre of the tree. All lateral wood-growths should be shortened back close to the main stem, while terminal growths or leaders must be shortened as shown in Fig. 270. Fruiting spurs must be judiciously pruned as shown in Fig. 271.

Plums require careful pruning, and in no case should the knife be too freely used. Many robust-growing plums, like *Victoria*, make a very luxuriant growth during the first two or three years after planting, and require little regulation. This, however, when possible, is best done by rubbing off the undesirable buds in spring, or by



FIG. 271.—An old fruiting spur of Pear, showing how, by degrees, the spurs extend in length and away from the main branch. To induce the formation of a shorter spur remove at the winter pruning the portion above *A*. *B, B*, points at which the spur has been previously shortened; *C, C, C, C*, scars remaining after removal of fruit; *D*, bud forming below scar, and which will ultimately form a fruit bud.

tying down the branches of strong robust growth in order to check the flow of sap, and direct it into the lateral buds, thereby inducing them to make a weak growth, and ultimately developing into fruiting spurs. Another very effective remedy, and one which applies equally well to all stone fruits, is to raise them bodily out of the ground, carefully remove the strongest roots, and replant them.

The sweet varieties of cherries produce their fruit buds in clusters (Fig. 272), and must therefore have their lateral growths shortened, or spurred back, to the main stem; in older trees spurs begin to form naturally without any artificial treatment.

Morello cherries fruit best on the long young shoots (Fig. 273) of the previous season's growth. If it is necessary to use a knife in regulating stone fruits, the work is more safely performed in

summer, as there is then less liability to gumming. In pruning black currants, all old wood must be periodically cut out close to the ground to encourage the growth of new wood. In red and white currants, lateral spurs should be encouraged as shown in Fig. 274.

**Root-pruning** is a term used to describe the lifting and pruning of a tree in order to check its naturally robust growth of wood, thereby causing fruit buds and fruiting spurs to be produced. The work is best performed when the leaves begin to fall, as the tree then has an opportunity of recovering itself, and making new wood, while the soil is still warm. It is very rarely that commercial fruit-growers



FIG. 272.—Branch of Cherry from old matured tree showing two years' growth. *A*, naturally formed spurs with clusters of flower buds; *B*, wood bud. Where an extension of the shoot is desired, it will be necessary to prune to a wood bud as at *C*.



FIG. 273.—Shoot of Morello Cherry showing two seasons' growth. *A*, *B*, young wood upon which fruit is borne and which must not therefore be shortened back; *C*—*A*, wood of preceding year's growth.

engage in root-pruning, as the practice is expensive, varying, of course, with the age of the tree. In the third and fourth years after planting, young apple- and pear-trees on strong-rooted stocks frequently develop an excess of woody growth, so that if the tree is lifted bodily from the ground, and the strongest roots are severed with a pruning saw, and afterwards pared with a sharp knife (Fig. 275), it should prove a sufficient check for all time.

In locating the large roots, the soil should be carefully removed, so as not to injure the root fibres, the largest of which should be

pegged to the ball of earth held by the roots. Where the soil is of a harsh character and not conducive in promoting the healing up of the wounds and the formation of new wood, much assistance will be afforded if several barrow-loads of old potting compost, or other rooting medium, is incorporated with the soil which is placed around the roots.

Training Fruit-trees, like propagation, is very largely a matter for the nurseryman, although when the trained trees leave his skilled



FIG. 274.—Fruiting Branch of Red Currant. When a bush is fully grown the main branches are stopped or pinched back in a manner similar to that recommended for laterals. *A*, terminal lateral growth produced through stopping the lateral branch; *B*, a strong competitive branch which should have been kept spurred back to the main stem. After checking a lateral growth *C*, a new shoot, *D*, often breaks from the base of the lateral; *E*, a short stubby growth or spur which need not be pruned; *F*, a similar spur bearing fruit. At the winter pruning cut back to two or three buds as indicated by cross lines.

hands, they very soon begin to assume all kinds of weird forms and shapes, due to a lack of knowledge on the part of the after-cultivator.

Bushes are a very serviceable form of tree, when special attention cannot be given to the more regular forms of training, and are generally adopted by fruit-growers, except when standards are planted to form orchards. A well-balanced bush can readily be formed by cutting back a maiden tree to within 1 foot or 18 inches of

the ground, allowing five or six buds to break, and later reducing them to three or four, which at the winter pruning should be cut sufficiently hard back to promote a good growth of branches to build up a foundation.

A pyramid tree is produced in much the same manner, evenly placed branches being more essential, while the upper side-shoots are pruned fairly close, in order to develop the lower branches, as well as the buds along the extension of each branch. The leader is reduced by about two-thirds of its length.

Standards, or, if need be, half-standards, are best adapted for orchards, where it is intended to graze cattle underneath; or where, as is very often the case, an orchard is set aside for the rearing of poultry, or as an apiary. The market grower, however, cultivates the ground beneath the trees, the standards taking up their position along with other varieties of fruits, vegetables, or flowers.

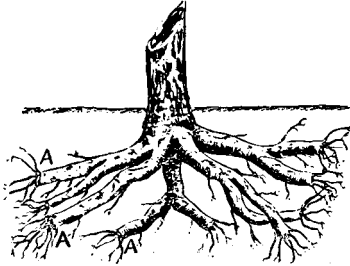

FIG. 275.—Root Pruning. Appearance of root and stock of apple one year after pruning. Young vigorous trees often make strong roots which penetrate into the subsoil and are devoid of the more useful fibrous roots which are conducive to fruit-bearing, and take their nourishment from the warmer and more nutritive surface soil. A, A, points at which old roots were severed.

In training a young standard tree, all growths with a tendency to develop towards, or across the centre must be removed, the pruning always being stopped at a bud or eye pointing outwards (Fig. 276).

Cordons may have single, double, or triple stems, and may be allowed to assume a horizontal, oblique, or upright position. All lateral growth must be pruned back to the single or main stem, and so be converted into fruiting spurs. The leader should be allowed complete freedom of growth, or the general health of the tree is liable to suffer, as there is little to induce the flow of sap to the extremities of the shoots if the leader is confined.

In training an espalier, allow three well-placed shoots to grow upright during the first summer, and, as winter approaches, gradually tie the two side branches down to a horizontal position; shorten back each growth sufficiently to promote strength, and an equal development of fruiting spurs. When the tree has attained the requisite height, cut back the leader to two buds, in order to arrest its progress upwards (see Fig. 277).



In a fan-shaped tree the main stems are uniform in size, and radiate from one common centre, to promote which growth a maiden tree should be shortened back by two-thirds of its length, and three well-placed shoots selected from the buds that break, the remaining buds being rubbed off. In the following spring when growth commences, shorten back each of the three shoots to within 6 inches of the stem, and allow two buds from each to develop, thereby forming the main branches of the tree, which should be equidistant from one another.

As standard and bush trees develop, large branches have often to be removed in order to open the centre of the tree. In all such cases the branch should be cut off close to the main stem, as otherwise a "snag" will result (Fig. 278).

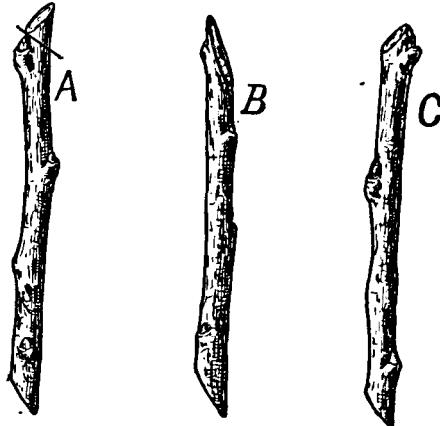

FIG. 276.—Wrong and right methods of Pruning. When the branch to be removed is not cut in the direction of a bud a snag is formed, as shown by the line at *A*. If a cut is made too low down or below the bud, as at *B*, the elaboration of sap is interfered with, and very often the bud does not develop, or if so very weakly. The illustration *C* shows a correct cut, and one which must always be performed whenever a young wood growth is removed, and the terminal remaining destined to become a leader.

A symmetrically trained tree cannot be produced unless the roots are well and evenly developed, therefore attention must first be directed towards a healthy condition of the root system.

Arrangement of Fruit Plantation.—An orchard or fruit plantation should be arranged with a view to economy in working, and, if it is desired to intercrop between the trees with vegetables or flowers, this will add considerably to the cost. If, however, the selection and arrangement is well thought out, and the subsidiary crops are managed and marketed in the best possible manner, the returns should be adequate to compensate the owner, by providing him and his employees with a livelihood until the permanent trees in the plantation or orchard come into bearing. As the standard or bush trees begin

to require more space, the work of transplanting or clearing the bush fruits and other plants gradually proceeds, until eventually the whole of the space is occupied by the desired types of trees.

The square system of planting (Fig. 279) is well suited for permanent plantations, and, although it admits of fewer trees per acre, it is more convenient for planting and working. The quincunx system (Fig. 280) allows of a much larger number of trees to the acre, and is usually adopted where it is intended to reduce the number by thinning. The triangular system (Fig. 281) is not so well adapted to a permanent plantation, as it does not admit of equal thinning. Yet another system is the hexagonal (Fig. 282).

Strong-growing varieties of apples and pears may be planted at 30 feet apart, medium-growing at 24 feet apart, and small-growing varieties, at 20 feet apart. For mixed plantations the 30 feet distance is to be preferred, as it allows for intercropping, and therefore appeals

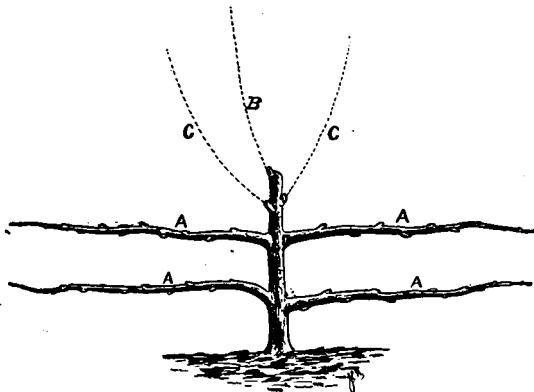

FIG. 277.—Young Espalier Tree with two pairs of horizontal branches, A, A, A, A. When laying in successive branches remove all surplus buds from the leading branch, selecting three well-placed buds, to form a leader B and two lateral branches C, C.

to the market gardener. Standard trees are planted 30 feet apart each way, with bush or pyramid apples, or half-standard plums, between them in the rows at 15 feet apart, and gooseberries or currants again between these at 5 feet apart.

In marking out ground for fruit-trees, always select the longest boundary or fence in the field, and peg out a straight line parallel to this boundary, at a distance of 20 feet from it, and place pegs at distances of 30 feet apart along this line. Next proceed to mark off a line at right angles to the last peg, and, as before, insert pegs every 30 feet. Now draw a line from peg No. 1 parallel to the first line, and again insert pegs at every 30 feet. Continue in this way until the whole of the ground is marked out into squares, the pegs, and later the trees, presenting straight lines in several directions. Crowding must always be avoided in mixed planting, especially where

vegetables are grown, and in no case must such crops approach the young trees nearer than 3 feet.

Whether the ground should be marked off in 12 feet or 30 feet squares must depend upon the system of planting and cultivation adopted. Those who are inexperienced must not attempt to plan or lay down a fruit orchard without first visiting a good fruit-growing district, where carefully cultivated orchards already exist ; also they should secure the services of a really practical man accustomed to planting.

Grass Orchards are not to be advocated, as they are considerably less profitable than where the ground below the trees is kept cultivated ; and further investigations have demonstrated that the grass roots secrete certain substances that are injurious to the surface

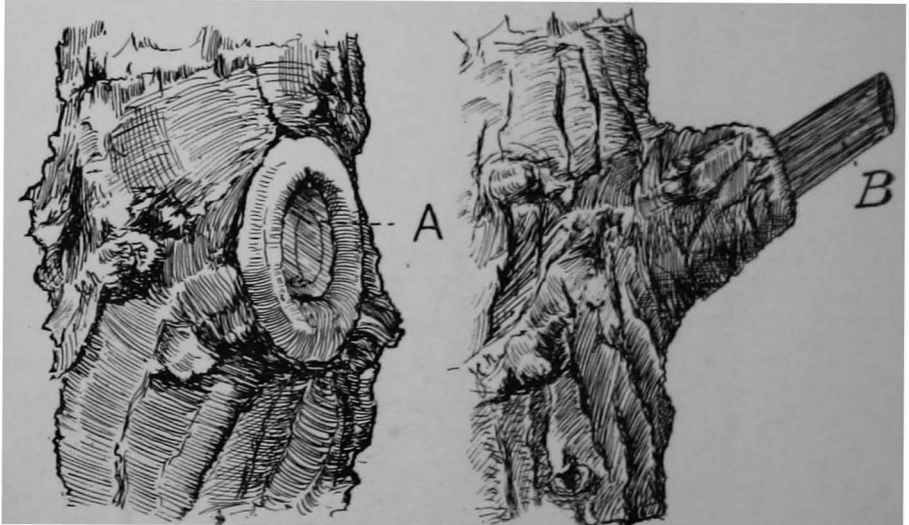

FIG. 278.—*A* represents the healing over of a wound after the removal of a large branch by sawing it off as close as possible to the trunk. *B*, when the branch is left to rot the snag prevents the wound healing, while very frequently the decay is continuous from the snag into the heart wood of the tree.

roots of the trees. Thus the better plan is to grow bush fruits between the standard apples and pears, and manage these bushes in a systematic fashion, so that they also, may receive their full share of nourishment.

**Selection of Fruit-trees.**—It is seldom that farmers have the time to propagate fruit-trees, nor is it advisable that they should. Healthy, well-grown trees of all the best varieties can be purchased very cheaply nowadays from nurserymen who specialize in the work.

There can be no greater mistake than purchasing fruit-trees at auction sales, as held at many country towns on market days, as with very few exceptions the lots are composed of surplus trees remaining after selections have been made by other purchasers ; while not unfrequently the varieties are wrongly named, or are badly

developed. Moreover, very often the exposure to which the roots are necessarily subjected gives a check to the tree from which it never fully recovers.

In asking for quotations, the exact type of tree, that is whether standard, half-standard, or bush, must be clearly defined, also the kind of stock on which they are grafted. Standards will usually have a clean stem some 6 or 7 feet in length between roots and branches; half-standards will possess about 3 or 4 feet of clean stem, and bushes from 12 to 18 inches.

Standards and half-standards, to possess the vigour of growth expected from them, must be grafted on crab stocks, and for a similar reason standard and half-standard pears should be on pear stocks, bush apples on broad-leaved Paradise, and dwarf bush pears on quince stock. There are of course a few exceptions which need not

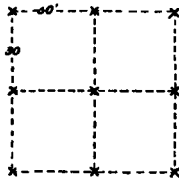

FIG. 279.—The Square System.  
X = standard fruit-trees,  
30 x 30 feet.

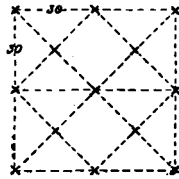

FIG. 280.—The Quincunx System.  
X = standard or dwarf fruit-trees. Lines usually arranged to alternate with dwarfs and standards.

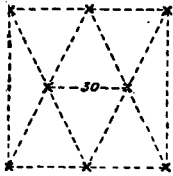

FIG. 281.—The Triangular System.  
X = standard fruit-trees.  
Distance between the trees and  
between the rows = 30 feet.

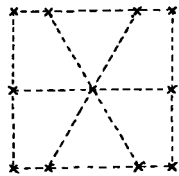

FIG. 282.—The Hexagonal System.  
X = standard fruit-trees. All  
the trees are 30 feet apart in  
every direction.

here be mentioned, as for example it is sometimes necessary to graft weakly constituted varieties of apples and pears on crab and pear stocks, respectively.

The price paid for trees must necessarily depend largely upon the number purchased, retail prices bearing very little, if any, relation to wholesale prices. Retail, standards and half-standard apples will cost from 1s. 6d. to 2s. 6d. each according to size; yearling trees, or maidens on broad-leaved Paradise stock, 1s. to 1s. 6d.; horizontally trained espaliers (two tiers), 3s. 6d.; single fruiting cordons, 1s. 6d. to 2s. 6d.; double cordons (lateral), 2s. 6d. to 3s. 6d.; pyramids or fruiting bushes, 3s. 6d. to 5s.

The utmost care must be taken to see that the trees are clean and free from the many injurious pests and fungoid diseases to which

they are subject. The same advice holds good for all kinds of fruit, particularly gooseberries and black currants. Injudicious selection may easily result in a plantation of trees becoming infested with gooseberry mildew, or big-bud in black currants.

**Varieties of Fruits.**—Many farm orchards contain worthless varieties of apples, partly due to the fact that years ago the many excellent varieties now on the market did not exist, neither were there so many exhibitions of fruit and other produce in county towns as there are to-day. Also, there was the too common practice of raising trees from "pips" or seeds, very few of which inherit the characters of the parent tree. Every student should visit, whenever possible, one or other of the principal fruit shows, of which many are held in provincial towns, as by so doing he will become acquainted with all the best types of hardy fruits in cultivation.

Of apples, there are considerably over 1,000 named varieties, but of these very often the showiest as regards size and colour, have very little more flavour than a field turnip; thus appearance is not a criterion of quality.

After all, the farmer, and even the market gardener, must of necessity make a very limited selection of those fruits he intends to cultivate, and the list at the close of this chapter will serve as a guide.

Every student should provide himself with a list such as that issued by the Royal Horticultural Society, and also have at hand a catalogue of one or other of the principal nurserymen, in which he will find a reliable description appended to each variety.

Care must be taken to find what variety suits the district in which it is intended to commence planting; and this information is usually forthcoming by making careful inquiries among local growers and gardeners.

When it is found that any particular variety of fruit is unsuited to the district or locality, the sooner it is replaced by something else the better. In the case of apples and pears, the stocks must not be grubbed out, but headed back in readiness for grafting in spring.

**Gathering and Marketing Fruit.**—Apples and pears are best gathered when ripe, or when they offer a slight resistance to picking, merely sufficient to break the peduncle or fruit-stem, without severing any of the adjoining spurs from the tree. If gathered too early, the fruit is liable to shrivel, although this defect is often caused by mis-handling during storage. Again, in low-lying districts, where early frosts are prevalent, flavour becomes affected, and this is often followed by premature decay.

Many fruits, gathered just before reaching maturity, are assisted in ripening by careful storage. A fine dry day should always be selected for gathering, first allowing heavy dews to lift, and the fruit to become thoroughly dry.

Much of what would otherwise be first quality fruit is spoiled through careless handling, and gathering when either under- or over-ripe. Keen competition, and the pressure brought to bear upon English growers by Continental and Colonial rivals, has contributed much towards a better system of grading, packing, and marketing

in this country. Whenever possible, apples, pears, and plums should be gathered by hand and carefully placed in pouches or baskets, and transferred, if necessary, into larger receptacles for removal to the packing shed. Fruits which may have fallen from the trees must be kept apart and marketed separately.

Grading should be done rapidly, with care and good judgment, and is often performed by passing the fruit through rings of various diameters. First quality dessert apples and pears are sold in boxes of from two to four dozen. First quality cooking apples are packed in similar boxes, or in flats, holding from 20 to 28 lb. or it may be 40 to 46 lb., according to the market. Seconds and thirds are usually packed in bushel or half-bushel sieves. Where boxes are used, these are generally non-returnable, which is a great boon to the purchaser.

The boxes used by Kent growers have the following dimensions:—inside measurements—length 20 inches, depth 10 inches, width 11 inches; outside measurements—length 21 $\frac{3}{8}$  inches, depth 12 $\frac{1}{4}$  inches, width 11 $\frac{1}{2}$  inches, with 1 in. battens. Lids, composed of two pieces 21 $\frac{3}{8}$  by 5 by  $\frac{1}{8}$  inches nailed to end batten, and 11 $\frac{1}{2}$  by 1 by  $\frac{1}{8}$  inches with  $\frac{1}{2}$  in. space between the centre of the two pieces. Bottom, two pieces 21 $\frac{3}{8}$  by 5 by  $\frac{1}{8}$  inches, and  $\frac{1}{2}$  in. space between the boards in the centre; sides, two pieces, 21 $\frac{3}{8}$  by 4 $\frac{3}{8}$  by  $\frac{1}{8}$  inches and  $\frac{1}{2}$  in. space between boards in centre; ends, one piece, 11 by 10 by  $\frac{3}{8}$  inches.

Some varieties of apples do not admit of boxing, and it suffices to say that no fruit smaller than that which works out at 4 $\frac{1}{2}$  tiers, or from 150 to 170 apples, should be boxed.

Choice dessert apples, like Cox's Orange and Ribstone Pippin, are often marketed in trays holding twenty-four fruits, each of which is half-wrapped in coloured tissue paper, together with a further wrapping of aspen wood-wool. Choice dessert pears, like Doyenne du Comice, are similarly packed in trays holding from six to twelve fruits. Other choice pears are often packed either in half-bushels, or in half-bushel boxes, measuring 20 by 11 by 5 inches, and holding from 48 to 100 fruits, in two layers. The commoner kinds are usually consigned to market in bushels.

*Cherries.*—Choice fruits are placed in punnets, or in small boxes or baskets, according to the demand, and the season. Eltons, Napoleons, and large soft black cherries are marketed in 12 lb. pecks, and culinary and ordinary varieties in half-bushels, of about 24 lb. Chips prove very useful for packing Morellos.

*Gooseberries.*—A choice dessert variety like White Lion, will usually sell well in 1 lb. punnets, or in 6 lb. chips, as also will the early dessert varieties. Later, the ordinary green, red, and yellow coloured berries will follow in 12 lb. pecks, and half-bushels of 28 lb.

*Strawberries.*—Early and choice fruits are best packed in 1 lb. punnets, which usually cost from 3s. to 4s. 6d. per gross, the higher priced being provided with wire handles. These are placed in crates to hold 24, 32, and 48 punnets, the cost of such crates being respectively about 1s. 10d., 2s. 2d., and 2s. 4d. each, or cheaper in large quantities.

The main crop of strawberries and raspberries, is marketed in non-returnable chip baskets, holding anything from 4 to 12 lb. of fruit, and varying in price from 12s. to 24s. per gross. Every care possible must be taken to see that each consignment is marked, so that the salesman knows who it is from. Fruits intended for jam must be marketed as such.

*Raspberries.*—The choicest dessert fruit must be carefully gathered with the stalks attached into 1 lb. punnets, and placed in boxes holding six or twelve punnets. Larger consignments, for culinary purposes, should be placed in 4 or 6 lb. chips, and, if for jam-making, in tubs, or, a better plan, if possible, is to consign direct to the jam manufacturer.

*Plums.*—Choice dessert plums like Coe's Golden Drop, Greengage, Jefferson's, etc., should be marketed in punnets containing one layer of fruit. Great bulks of plums, however, are best placed in half-bushels of from 24 to 28 lb.

Selected ripe Victorias, Prince of Wales, including greengages, sell well in 12 lb. pecks.

Appended is a list of hardy fruits and varieties suitable for general cultivation. Full descriptions of these varieties will be found in any trade catalogue. The apples are in the order of ripening.

#### Apples (Dessert).

Beauty of Bath.	Ribstone Pippin.
Mr. Gladstone.	Allington Pippin.
Irish Peach.	Cox's Orange.
Lady Sudeley.	Winter Quarrenden.
Devonshire Quarrenden.	Scarlet Nonpareil.
James Grieve.	Gascoyne's Scarlet.
Worcester Pearmain.	Braddick's Nonpareil.
King of Pippins.	Court Pendu Plat.
Cox's Pomona.	Sturmer Pippin.
Blenheim Orange.	

#### Apples (Cooking).

Duchess of Oldenburg.	Golden Spire.
Lord Suffield.	New Hawthornden.
Ecklinville.	Tower of Glamis.
Lord Grosvenor.	New Northern Greening.
Pott's Seedling.	Bismarck.
Grenadier.	Alfriston.
Frogmore Prolific.	Bramley's Seedling.
Stirling Castle.	Lane's Prince Albert.
Warner's King.	Newton Wonder.
Lord Derby.	

#### Pears (Dessert).

Jargonelle.	Doyenne du Comice.
Clapp's Favourite.	Marie Louise d'Uccle.
William's Bon Chrétien.	Marie Louise.
Comte de Lamy.	Pitmaston Duchess.
Louise Bonne of Jersey.	Emile d'Heyst.
Beurre Hardy.	Beurre Diel.
Durondeau.	Josephine de Malines.

Beurre Clairgeau. Uvedale's St. Germain.  
 Catillac. Verulam.

Pears (Cooking).

Elton. Archduke.  
 Early Lyons. Bedford Prolific.  
 Empress Eugene. Black Eagle.  
 Early Rivers. Black Heart.  
 Frogmore Bigarreau. Bigarreau (Kent).  
 Black Tartarian. Noble.  
 Governor Wood. Bigarreau Napoleon.  
 May Duke.

Cherries (Dessert).

Kentish. Morello.  
 Wye Morello.

Cherries (Cooking).

Greengage. Prince Englebert.  
 Sultan. Kirke's Blue.  
 Cox's Emperor. Victoria.  
 Rivers' Early Transparent. Coe's Golden Drop.  
 Jefferson.

Plums (Dessert).

Early Prolific. Cox's Emperor.  
 Czar. Pond's Seedling.  
 Old Orleans. Prince Englebert.  
 Sultan. Victoria.  
 Gisborne's. Rivers' Monarch.

Plums (Cooking).

Gooseberries.

*Red Varieties.*

Bobby (l.). Old Rough Red (s.).  
 Crown Bob (l.). London (l.).  
 Clayton (l.). Lord Derby (l.).  
 Champagne (s.). Rifleman (l.).  
 Dan's Mistake (l.). Speedwell (l.).  
 Ironmonger (s.). Warrington (s.).  
 Lancashire Lad (l.). Winham's Industry (l.).

*Yellow Varieties.*

Broom Girl (l.). Keepsake (l.).  
 Champagne Yellow (s.). Leader (l.).  
 Early Sulphur (s.). Leveller (l.).  
 Golden Drop (s.). Stella (s.).

*White Varieties.*

Bright Venus (s.). Lady Leicester (l.).  
 Careless (l.). Lancer, Howard's (l.).  
 Cheshire Lass (s.). Whitesmith (l.).

*Green Varieties.*

Admiration (l.). Ocean (l.).  
 Greengage (s.). Plunder (l.).  
 Green Gascoigne (s.). Roseberry (s.).  
 Langley Gage (s.).

(l.) denotes large fruiting varieties suitable for exhibition purposes, also for dessert and cooking. (s.) denotes trees producing small berries, which are usually of excellent flavour.



**Currants.***Best Black Varieties.*

Baldwin's (Carter's Champion).	Boskoop Giant or Mammoth.
Black Naples or White Bud (Maple, Green Bud).	Lee's Prolific.

*Best Red Varieties.*

Scotch Red (Moore's Seedling, Champagne Red, Knight's Early).	Raby Castle (Victoria, Late Dutch, Houghton Castle).
New Dutch Red (Chiswick Red, Defiance).	La Versailles (Fay's Prolific, Comet, La Fertile).

*Best White Varieties.*

White Transparent (Versailles).	Shilling's Cut-leaved White.
White Dutch (White Grape).	

**Strawberries.**

Laxton's Noble.	Mentmore.
Royal Sovereign.	President.
The Laxton.	Sir Charles Napier.
Vicomtesse Héricart de Thury.	Sir Joseph Paxton.
British Queen.	Elton Pine.
Countess.	Fillbasket.
Dr. Hogg.	Latest of All.
Leader.	Trafalgar.
Louis Gauthier.	Valluff.
Monarch.	Waterloo.

**Raspberries.***Red Varieties.*

Baumforth's Seedling.	Norwich Wonder.
Carter's Prolific.	Red Antwerp.
Hornet.	Superlative.

*White Varieties.*

Grosse Blanche.	White Antwerp.
Guinea.	White Magnum Bonum.

*Autumn Fruiting.*

Perpetual de Billard.	Yellow Four Seasons.
-----------------------	----------------------

**Blackberries and Allied Fruits.**

Parsley-leaved Blackberry.	Japanese Wine-berry.
Cumberland Blackcap.	The Logan-berry.
Lucretia.	The Strawberry-Raspberry.
The Lawson.	Newberry.
Wilson Junior.	King's Acre berry.

**Storing Fruit.**—A fruit-room should occupy a dry, airy, situation, above ground, but free from draughts, and should always maintain an even temperature and not too dry an atmosphere—a room that is comfortably warm in winter, and cool in the hottest day in summer. The temperature in winter should not fall below 35° F. if avoidable, while from October to March if it ranges from 45° to 47° F., so much the better.

Fruit has a tendency to shrivel when it is warmer than the surrounding air, thus it is important to guard against alternate sweating and drying, caused by variations in temperature. Only subdued light must be admitted to a fruit-room, some fruits keeping best in total darkness.

The characteristic qualities of fruit are developed by keeping, and only those fruits which are sound, unblemished, and free from insect attacks should be stored; while periodical examinations must be made in order to remove those that are becoming spotted, or are over-ripe. Damaged, and over-ripe, fruits quickly spread decay, and the moisture arising from them has a disastrous effect upon the perfectly sound fruit among which they are placed.

Whenever possible fruit should be placed in single layers, especially in the case of the softer varieties. Late apples of firm flesh, such as Sturmer Pippin, Norfolk Beaufin, Bramley's Seedling, and Wellington, may be heaped to a slight extent without becoming injured. Among the best late-keeping dessert apples, best suited for storage during the early months of the year, are Nonpareil, Sturmer Pippin, Court Pendû Plât, and Cox's Orange Pippin; and among cooking apples, Bramley's Seedling, Norfolk Beaufin, Alfriston, Lane's Prince Albert, and Newton Wonder.

#### FLOWER CULTURE.

An important subject like floriculture cannot well be ignored in connexion with general farming, as in recent years many farmers in the vicinity of large towns have turned their attention, not only to the cultivation of fruit and vegetables, but also to the production of flowers for market. Fortunately for the cultivator, the great majority of flowering or foliage plants, suitable for decorative purposes, are no more difficult to raise than many of the ordinary farm crops.

The cultivation of fruit, flowers, and vegetables for exhibition, entails considerable skill, experience, and judgment, but where plants are grown for commercial purposes there is no need to exceed the ordinary limits of cultivation. The success attending the cultivation of flowers, as with other plants, depends very much upon the natural adaptability of the soil and climate to their growth. For example, it is observable that the cultivation of flowering plants such as lavender, carnations, violets, roses, and many species and varieties of bulbs, has been restricted to certain districts for this reason. There is no limit to the species and varieties of flowers capable of being grown for market, and, as with fruit, large consignments are received from the Continent, and wherever facilities exist which enable the grower to compete in the home market. For example, large quantities of lilies, daffodils, narcissi, and other early flowering plants, reach Covent Garden and the provincial markets from the Channel and Scilly Isles, the South of France, Holland, and from elsewhere.

The cultivation of bulbs for cut flowers is fast increasing in the southern counties of England, and especially in Cornwall, where the climatic conditions are particularly favourable for early production.

Flowering shrubs, herbaceous perennials, annuals, biennials, and a large assortment of tuberous and bulbous plants all contribute largely to the cut flower trade. To acquire a knowledge of the many kinds of flowering plants grown to meet the demand for cut flowers, necessitates periodical visits to Covent Garden Market throughout the year. The writer has had an opportunity of doing this, and believes that it is the only possible means of becoming intimately acquainted with this section of the industry, and most important if flower-growing is to be made a speciality. Few students, however, can enjoy these opportunities, so that it must suffice to say that whatever plants are selected for cultivation, a thorough knowledge of their management is absolutely necessary, while, in addition to this, the cost of production, and the marketable value of the crop, must be carefully thought out, by studying the prices of preceding years at the seasons in which the flowers are best placed on the market.

Many growers of flowers have reaped handsome profits by popularizing certain varieties which appeal to them as possessing such characteristics of flowers or foliage as will commend them to the public. As an example of such enterprise, *Physalis Franchetti* may be quoted, the bright-coloured capsular fruits of which enable it to rank among the most attractive decorative plants for winter use. Chrysanthemums, and sweet-peas, are instances of the great improvement effected by hybridization; as probably no plants produce a greater variety of colour, combined with gracefulness and effectiveness from the florist's standpoint than these; with the exception of the many species and varieties of orchids such as cattleyas, cyripediums, masdevallias, odontoglossums, vandas, and many of the beautiful flowering exotic plants, which require very special treatment—altogether outside the sphere of the market gardener.

As in the spacing of other plants, sufficient room must be given, to enable the plants to develop to reasonable dimensions, and in order to facilitate cleaning operations. The many beautiful varieties of asters, aconites, campanulas, chrysanthemums, delphiniums, gypsophila, helianthus, pyrethrums, phloxes, and solidagos, may be regarded as plants which may be suitably employed for the production of flowers for decorative purposes. Between the rows of these hardy perennials, quick-growing annuals such as china asters, pansies, poppies, wallflowers, stocks, and other annuals, or even biennials, may be grown as catch-crops, according to the time required for the perennials to come to maturity; or, if necessary, vegetables may be substituted.

The many kinds of bulbs and tubers such as daffodils, narcissi, tulips, and gladioli are best grown in beds of sufficient width to admit of the workers easily reaching the centre, for the purpose of cultivating the ground and gathering flowers—alleys, or paths, some 15 or 18 inches wide, serving as divisions.

Flower cultivation must always be regarded as intensive, entailing a heavy labour bill, deep ploughing, and the incorporation of heavy dressings of farm-yard and artificial manures. In planting bulbs, the common practice is to remove, say, 4 inches of the surface soil, previous to placing the bulb in position—daffodils, narcissi, and

tulips being placed in rows some 3 inches or so apart, while gladioli and the stronger-growing bulbs should be allowed 6 inches. The work of planting is effected by removing a similar depth of soil from the next bed, and placing it over the bulbs, and so on until the work is completed. The soil from the first bed is placed in such a position as will enable it to occupy the position of that removed from the last bed, much in the same way as is practised in trenching.

Annuals are usually sown from February onwards, according to their capacity for withstanding frost, while in some instances sowings are made in November, when, if protected by hand-lights, strong plants are procurable in early spring, from which a profusion of bloom is obtained. In the South of England little difficulty is experienced in obtaining a wealth of chrysanthemum bloom of the earliest varieties from August to October, while, should the weather remain open, the later flowering varieties will bloom up to Christmas. Single, and cactus dahlias are also in good demand for autumn decoration, but the supply is often arrested by a single night's frost. Where market gardeners engage in the cultivation of tomatoes under glass, or in cheaply erected span-roofed houses, large numbers of late-flowering Chrysanthemums are dug up from the open and planted into the soil previously occupied by the tomatoes, when, if well watered, and given plenty of air to prevent the damping of the foliage and flowering buds, an abundance of clean healthy blooms are obtained late into the year.

The student is recommended to study the very elaborate and beautifully illustrated catalogues of those firms who specialize in the cultivation of decorative plants, and never to miss an opportunity of visiting nurseries or private gardens where the large majority of these plants are to be seen in flower. As with fruit, there are many beautiful plants, the flowers of which, however, are quite useless for market purposes, on account of their not being able to retain their freshness and rigidity when cut, or to admit of that amount of handling which is an essential property of all flowers grown for the wholesale and retail trades.

**Potting.**—The importance of studying the correct method of placing plants in pots cannot be overestimated. Tender seedlings are often pricked out into shallow pans or boxes before potting, and, in doing this, care must be taken to make a sufficiently deep hole with the dibber to admit of the primary roots of the plant going straight down into the soil, and to avoid burying the plant too deeply. In all cases the seedling leaves must be freely exposed above the surface. Begonias, gloxinias, and seedlings of similar texture are so delicately constituted that forked or pointed sticks are used to transfer them from the seedling pans to boxes, in order to avoid damage in handling. The pricking out of seedlings gives useful practice to students, as the work not only demands considerable care, but trains the eye to symmetry, and in addition there are many little details of extreme importance, such as shading, ventilation, and watering, to be attended to.

When the plants have become sufficiently well rooted they are placed in pots, the soil of which is compounded in keeping with the requirements of the particular species and variety of plant (see

Artificial Soils). The ordinary flower-pot is porous, thereby admitting air to the roots of the plant. The evil results of attempting to grow plants successfully in glazed pots has been frequently demonstrated, and it is in order to preserve thorough aeration that good gardeners insist upon having all pots thoroughly washed and cleansed before use.

In potting the student will probably receive his first lesson in drainage, as in order to admit of the free passage of water through the soil it is necessary to lay a concave potsherd over the hole in the bottom of the pot, and over this smaller portions are laid, followed by a few pieces of fibrous turf to complete the drainage and to prevent any pieces of fine soil working into the watercourse below, thus hindering the free passage of water (Fig. 283).

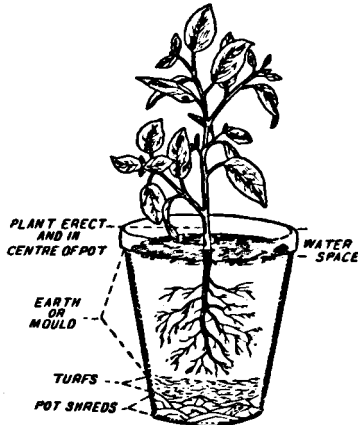

FIG. 283.—Diagram of Potting.

In potting the following rules should be carefully observed:—

1. A potting compost must be neither too wet nor too dry. If too dry, much injury is done to the delicate root-hairs, and it is also a difficult matter to thoroughly saturate the compost when placed in the pot. Should the compost be too wet and of a retentive character, it becomes kneaded together into a dough-like mass, which renders it hard and impenetrable when dry, usually accompanied by shrivelling and cracking.

2. The large majority of plants require to be potted in spring, as they show signs of making new growth. The soil surrounding the roots should be moist (not wet) at the time of potting, except where it is necessary to shake all the old or expended soil free from the roots, or where the roots are annual as with many bulbs and tubers.

3. Soft-wooded plants, and those of rapid growth like begonias and geraniums, must not be potted too firmly. Hard-wooded plants

and those of slow growth, like azaleas and ericas, possessing fine wiry roots, require firm potting.

4. Care must be taken not to over-pot delicate plants, and tubers starting into growth; rather give two or three moves into larger pots during the growing period. Many flowering plants, including a large number of bulbs, flower more freely when pot-bound, or confined to a limited amount of root-space.

5. Newly potted plants require to be watered with a rose-can until the surface soil has become consolidated.

6. When potting, never over-fill the pot with soil; leave from  $\frac{1}{2}$  to 1 inch as a receptacle for water.

7. The main stem of the plant should be in the centre of the pot, and perpendicular to the surface of the soil, irrespective of any irregularities of branching, form of head, etc.

8. Never stand plants in saucers of water, except in the case of fine semi-aquatic and rank-growing species; wherever possible allow a free access of air to the hole at the bottom of the pot, by placing it free of the staging.

9. Through exposure to the air, continuous watering, and especially when manurial stimulants are applied, the surface of the soil becomes covered with slimy and mossy growth. This must be periodically removed to admit of better aeration, while it may also be necessary to apply new soil in the form of a top dressing.

**Artificial Soils.**—Artificial is a term applied to soils compounded in order to suit the requirements of plants, a healthy growth of which cannot be ensured in soils that exist in their natural form, even though subjected to ordinary methods of tillage and manuring. The compounding and mixing of soils more directly concerns the cultivation of exotic and other plants than it does the farmer or the market gardener, as, although in their case better results could be attained by the importation and blending of soils of distinct characters, the cost of such a procedure might be ruinous financially.

In the cultivation of vines, peaches, nectarines, melons, figs, and other choice fruits rich fibrous loam is largely employed in making up beds or borders for their reception. Roses, when on their own stocks, or those of the briar or wild rose, do not grow freely on light soils, therefore it is customary to incorporate clay with those of a light sandy character in order to make them more retentive of moisture, and to obtain a better medium in which the plants can secure a firm root-hold. Farmers often apply chalk to sandy soils to make them more adhesive, while the paring and burning of heavy clays produces the opposite effect, and, further, where finely ground caustic lime is spread over heavy land, its action tends to lighten the soil and make it more easily workable, but these and any other methods adopted by the farmer are only means of improving existing soils.

The gardener before he can become a successful cultivator must know what soil conditions are best suited to the growth of the many classes of plants entrusted to his care. Heavy retentive loam, peat, sand, decayed leaf-mould or humus, sphagnum moss, together with old mortar or brick rubble, broken potsherds, charcoal, road-grit, and

many other substances, enter in varying quantity into the composition of potting soils.

Roses, when grown in pots, also chrysanthemums, terrestrial orchids, and even some species of ferns, like *Adiantum Farleyense*, thrive in soils largely composed of fibrous loam of a retentive or even clayey consistency, with which is incorporated a sprinkling of silver sand to assist porosity. Other species of *Adiantum* or maidenhair fern, and *Davallias* or hare's foot fern, revel in peaty soils, as also do many

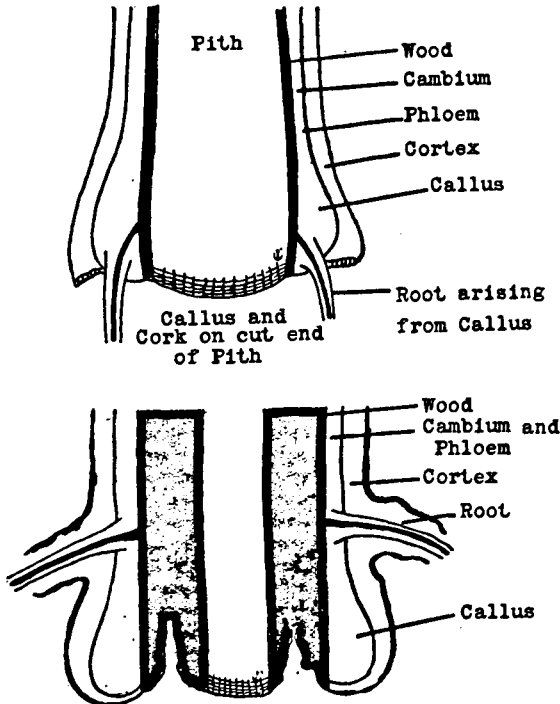

FIG. 284.—Diagrammatic Longitudinal Sections through the base of a herbaceous (upper) and of a woody (lower) cutting.

other plants such as heaths or ericas, azaleas, and rhododendrons. Several species of orchids, notably cattleyas, vandias, and others of similar habit of growth, thrive in little more than a compost of broken potsherds, sphagnum moss, and charcoal.

Plants which require little water succeed in soils of a dry character, a condition often attained by mixing ordinary loam with an abundance of old mortar rubbish and sand, to admit of the free passage of water, an essential with regard to the cultivation of agaves, cacti, aloes,

phyllocaeti, and many others possessing a thick leathery epidermis, to which a stagnant or waterlogged condition of the soil is fatal.

By carefully studying the habits of plants under cultivation, particularly with regard to root action, a very accurate guide can be formed as to their soil requirements. The student should make careful comparisons between the roots of aquatic and semi-aquatic plants and those which prefer and inhabit soils of a drier character. He should also note the behaviour of these roots when they are placed in soils of an uncongenial character. Further, it is necessary to distinguish between succulent stems of a herbaceous character and those of a woody texture as shown in Fig. 284. Such distinctions are invaluable to the propagator who knows from experience that

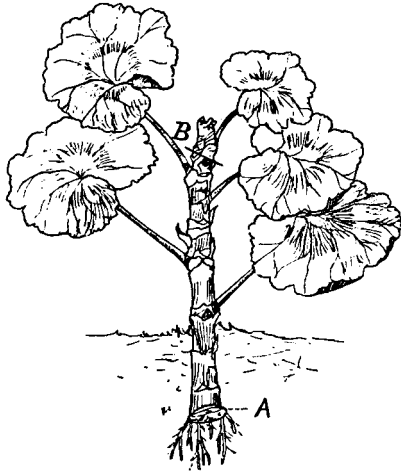

FIG. 285.—Cutting or slip of Geranium with short internodes denoting well-seasoned or ripened wood. When a number of roots protrude from the callus as at *A* the growing point should be pinched out in order to promote lateral growth from buds in the axils of the leaves, thereby tending to the production of a bushy and evenly balanced plant.

cuttings of fibrous, but not woody, textured plants such as geraniums (Fig. 285), and many other soft wooded types callus and produce roots quicker than those the wood of which is hard and often brittle, quite irrespective of whatever rooting medium they are placed in.

*Trenching.*—The beneficial effects of trenching are shown in Fig. 286.

Very few soils admit of deep trenching, this operation being largely restricted to garden soils that have been cultivated for a long series of years. The importance of the increase of the root area of plants due to trenching cannot be overestimated, especially



in seasons of drought, and some vegetables are known to penetrate the soil to a depth of as much as 3 feet, with a proportionate development of growth above ground. Improvement in the quality and texture of a soil can only be effected gradually; therefore

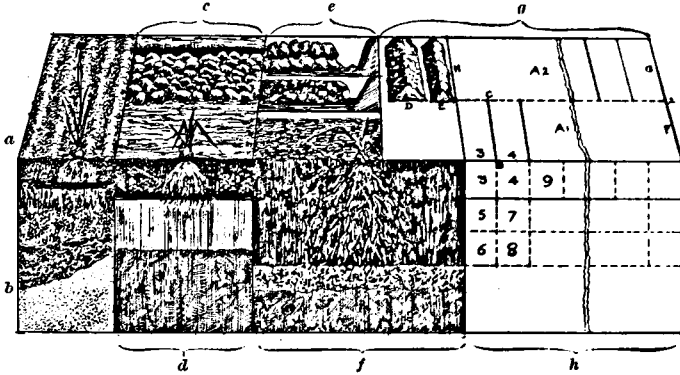

FIG. 283.—*a*, surface effect of ploughing and digging; *b*, section showing depth of plough, pan, and subsoil; *c*, surface effect of digging and raking; *d*, section showing that a greater depth of soil is obtained by digging than by the plough; *e*, sections of digging, the lower demonstrating the surface effect of frost and the amelioration of the soil; *f*, section of trenching, showing the greater depth of soil obtained and drain tile in subsoil; *g*, plan in diagram of commencement of trenching operations; *h*, section of *g*. *A1*, *A2*, the two halves of the ground to be trenched; from *B* to *C* the soil is removed two spades wide and one spade deep at 3 and 4 and placed in a heap *D*; remove subsoil 5 and place in heap *E*; 6 is then dug one spit deep but left at the bottom and the upper subsoil 7 turned upon it, and the surface soil 9 upon the subsoil 5; the process is repeated until *F* is reached, when it will be found that spaces exactly like 3, 4, and 5 are left; these are filled with the soil and subsoil from *G*; *A2* is then trenched and the spaces remaining at *H* filled with the heaps *D* and *E*.

careful judgment is necessary before deep trenching is performed. For example, if an unfertile soil is brought to the surface it would prove more detrimental than helpful to growth.



FIG. 287.—Bastard Trenching.

*Bastard Trenching*.—Bastard trenching differs from ordinary trenching inasmuch as the lower stratum of soil is not brought immediately to the surface, but remains in its original position, after having been incorporated with such manurial material as is

likely to ameliorate its condition. For example, in converting an old pasture into a kitchen or vegetable garden the subsoil (Fig. 287, D) would be broken up to the depth of a digging fork and well incorporated with manure. Over this the turf from A would be inverted and broken up with the spade as shown at E, while the section F would represent the top spit of soil (B) underneath the turf (A). Section G now representing the top soil is the upper half of the subsoil C. Assuming that the operation has been carried out during the winter months, a good coating of manure would be applied to section G in spring. In this way a rapid improvement in the soil is effected, and at a later period section D would be brought to the surface.

## CHAPTER III.

### MISCELLANEOUS OPERATIONS.

PLANTS in a state of cultivation, and when grown under unnatural conditions, require an adequate supply of moisture. Drought, as well as excessive moisture at the roots, will both prove equally harmful, as illustrated by the shrinkage in the yield of cereal and root crops harvested after a dry rainless summer ; or in the case of "burnt-up" pastures. On the other hand the same crops, when produced on a saturated or waterlogged soil, soon sicken, as indicated by the foliage turning yellow, owing to the decay of the root. The student may have observed this happening in fields of wheat, when during wet weather the rain-water has not passed freely through the soil. A broken drain-pipe, or a drain that has become blocked, will often account for the flooding of quite large areas.

Water is the most abundant and important ingredient of the plant, and cannot be dispensed with. It acts as a solvent and transporting agent, in the conveyance of the various food materials that enter the plant by the roots. Water is essential for the manufacture of carbo-hydrates, and is required by the enzymes, upon the activity of which the many chemical changes which take place in the plant is dependent.

Water is responsible for the turgescence of the cells, thereby giving rigidity to the stem and leaves. Thus, when plants droop or "flag" and the leaves "wilt" it is a sign that they require water at the roots. In some instances, evaporation of moisture takes place so rapidly from the leaves, that the roots fail to keep up the supply, notwithstanding that abundance of water is present in the soil. This drooping of the leaf is often seen in the case of mangels, cucumbers, melons, and vegetable marrows ; and other plants with large leaves from which watery vapour is readily exhaled. A similar illustration is afforded by cabbages on a hot sunny day, after weeks of dull weather, early in the season, when the plants were in an active state of growth.

The water, having deposited various food constituents in the leaf, finds its way out, partly through the outer cell-walls exposed to the air, but chiefly through the stomata, which are situated on the upper and lower surfaces of the leaves. It has already been seen that some plants transpire much more readily than others, the degree of transpiration depending very largely upon the structure of the epidermis of the stem and leaves.

Plants are indigenous to certain kinds of climates and soils. Many are of aquatic character like the water lily, while others, like members of the Rush family, are semi-aquatic. A very large percentage, including the greater majority of cultivated plants, require soil of a moist, warm, and well-aerated character, while others thrive in countries where the rainfall is low or absent, and the atmosphere is dry and arid; as, for example, agave, aloe, cereus, mesembryanthemum, sedum, etc., the leaves of which are thick, succulent, and leathery in texture. The common house leek is a plant of this character, and can certainly take care of itself throughout periods of drought, as it grows and flowers freely on the roofs of houses. However slow the evaporation from the leaves, or the amount absorbed by the roots, water is continually flowing through the plant, and it is the rate of this circulating current that determines, more than any other factor, the amount of water required.

There are many influences which affect transpiration, the principal being the heat or temperature of the soil and air, and the higher the temperature, the more rapid the transpiration. The more humid the atmosphere, the slower will transpiration take place, and this is why gardeners adopt the practice of "damping down", or dispersing water by means of a syringe or watering-can in greenhouses during spring and summer, when plants are growing rapidly. It is also very largely for this reason that the floors of melon- and cucumber-houses are kept continually damp. Light regulates the transpiration current, as, quite apart from any ill effects that may attend the scorching of plants under glass by the action of the sun's rays, gardeners smear white-wash or "summer cloud", or other adhesive colouring compound over the glass, in order to shade the occupants of the house from strong light, and so check excessive evaporation of moisture from the leaves.

The best contrivance for this purpose is that of roller blinds, which admit of being let down or rolled up, according to the intensity of the sunlight. Delicate, moisture- and shade-loving plants, like filmy ferns, require very special care in order to protect the fronds from becoming dry through lack of moisture in the atmosphere, or through exposure to strong light. Cacti, on the other hand, enjoy the best health when exposed to the scorching rays of the sun, and allowed a sparing supply of water, and this, only in the height of the growing season.

The amount of water transpired is still further to be regulated in keeping with the concentration and chemical nature of the soluble salts present in the soil, while many more minor influences might be recalled, but these should be ample to impress upon the student the great importance which attaches to the operation of watering cultivated plants, more especially those whose roots are confined in pots, and grown under glass or other covering.

Of field crops, 300 lb. may be taken as a fair average of the amount of water transpired per pound of dry matter produced in the plant. It is in estimating the transpiration of different crops that an approximate idea is obtained of the amount of water per acre necessary to produce an average yield. It must be remembered that

whether the rainfall is light or heavy, the greater part of it falls in the colder months of the year, before most crops are sown, while those already in the ground are not in an active state of growth, and therefore do not require water during a period of temporary rest.

In the South of England, where the rainfall rarely exceeds 26 inches per annum, the conservation of the water supply presents a problem of extreme practical importance, and farmers have come to realize the necessity of keeping the surface of retentive soils well stirred with the hoe during dry weather, thereby forming a "mulch" over the capillary tubes of the soil (Fig. 288), and preventing the escape of moisture from below. This surface layer of soil acts much in the same way as does straw, or a layer of manure, placed over dry soil, when in the course of a few days moisture will be found to have collected on the underside of the covering or mulch.

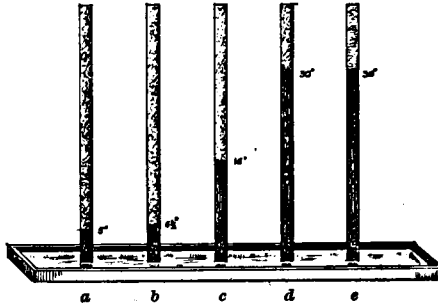

FIG. 288.—Capillarity. Showing approximate power of different soils to raise water.

- |       |  |
|-------|--|
| a.    | Tube containing coarse particles of clay raising water 5 inches. |
| b.    | " " fine " " 6½ "  |
| c.    | " " sand raising water 16 inches."                               |
| d, e. | Tubes " fine loam " 30 "   |

In watering pot plants, the fatal error is frequently made of giving dribblings of water to the plant whenever the surface appears dry, whereas the proper course is to give the soil a thorough soaking; when, if the surface is kept well aerated, the moisture will be drawn up towards it from below, and the plant need not again be watered until the lower reserve of moisture has been exhausted.

It has been suggested by Mr. Strawson that watering may be regularly carried out by means of long porous earthenware vessels kept filled with water. These are sunk in the ground, and the seeds are planted in the soil outside, but in close proximity, to the porous vessel. Mr. Strawson finds that the moisture slowly percolates through the earthenware, and keeps up a continuous but sufficient amount of moisture without an excess, and that seedlings so placed grow in a satisfactory manner. This system may be recommended for choice growths, and quite limited areas.

## VEGETABLES AND SALADS.

A kitchen garden should not be larger than will admit of proper attention being given to it, and the more intensive the cultivation the better will be the result. Where there is no choice of soils, the best must be made of that which exists, but good deep loams are rarely associated with heavy woodland, or upland farms. The yields of the various crops, or (if we regard an individual crop, such as onions), the size of the bulbs will be in keeping with the amount and quality of the manure supplied. If seed from the same packet be sown on poor, hungry soil, and on rich soil deeply trenched and well supplied with manure, the poor ground will only produce bulbs of the size of pickling onions; while the richer and well-manured soil will produce bulbs of from 2 to 3 lb. weight.

A definite system of rotations is essential for garden crops, but, just as it is possible to grow mangels on the same ground for a number of years in succession, provided the necessary cultural details are attended to, so it is possible to grow a crop of onions on the same plot of ground for a number of consecutive years. Among the many advantages in favour of rotations are: That:—

1. Some crops are a good preparation for others, as for example celery for onions. In this case the soil, having been earthed up in the process of blanching, becomes mellow and deeply worked, thereby favouring the growth of a deep-rooting plant like the onion, the roots of which will penetrate to an average depth of 2 feet in trenched ground.

2. A rotation assists in arresting or checking insect and fungoid attacks. For example, where carrots become badly infested with the grubs of the carrot fly, it would not be wise to sow the same ground with carrots in the following year, or should a crop of onions become attacked by onion mildew it would be equally foolish to attempt their cultivation in that soil in the following year.

3. Deep-rooting crops, like the long varieties of carrots, beet-root, and parsnips, enrich the surface soil for the benefit of shallow-rooting plants, such as the dwarf varieties of these vegetables, together with turnips, and the many kinds of salads.

Plants of the same natural order, such as cabbages, brussels sprouts, cauliflower, and kale, which all belong to the Brassica family, usually require food constituents in similar quantities, and of similar character; therefore it would not be considered good practice for these crops to follow one another in rotation. The same remark applies to plants belonging to the natural order Leguminosæ, that is pod-bearing plants, such as beans, peas, etc., which, in addition to requiring soil-foods of the same character, are so constituted as to be able to make use of atmospheric nitrogen.

Many vegetables, although requiring a fair amount of nourishment, do not respond to heavy dressings of farm-yard manure. The potato affords an instance of this, heavy dressings of dung tending to encourage coarse growth, the haulm attaining enormous dimensions, as a result of which few tubers are found at the root. This vigour of stem and foliage is largely due to an excess of nitrogen, and

a deficiency of phosphates and potash. Members of the Brassica family revel in heavy soils well charged with manure, the plants being naturally gross feeders, and having to produce a wealth of foliage, without which well-developed "heads" of cabbage, cauliflower, or broccoli would not be forthcoming. Potatoes may follow any of the above plants, or winter greens, including the many varieties of kale, all of which are removed from the ground sufficiently early in spring to admit of potatoes being planted, in which case no further manuring may be necessary.

Garden vegetables include the artichoke, asparagus, bean, beetroot, borecole, broccoli, brussels sprouts, cabbage, carrot, cauliflower, celery, leek, lettuce, onion, parsnip, pea, potato, radish, rhubarb, spinach, turnip, to which may be added a number of saladings such as chervil, chicory, endive, mustard and cress, parsley, taragon, etc.

The above vegetables are represented by many distinct varieties, some of which are identical in character, but are catalogued under many different names, occasioning much confusion. Reliable selections of each vegetable will be found in seedsmen's catalogues, but to recognize the varieties by sight, the student is recommended to examine carefully whatever varieties he may have an opportunity of inspecting, taking particular notice of those perfect types exhibited at shows, and elsewhere.

Success in vegetable culture, as in arable farming, can only be achieved by giving careful attention to soil preparation, and to the plants during their growth, and by keeping the ground free of weeds, and deeply stirred with the hoe.

**The Seed-bed.**—The preparation of a good seed-bed is the first essential of success. If the soil is of a heavy retentive character it must be deeply dug, and well ridged up during autumn, if possible by December in order that it may become mellow and easily workable in spring. A seed-bed must be firm and well aerated, the particles of soil being well consolidated by treading or rolling, but not to such an extent as will interfere with its porosity. A fine tilth, or soil division, is necessary to facilitate shallow sowing, as the shallower all seeds are sown within reason, the sturdier and stronger will be the seedlings. A soil, in which the particles are fine, and in close contact one with another, is retentive of moisture, and capillarity is greater in proportion to the closeness of the particles.

The Brassicas, and, in fact, all plants which are transplanted from a seed-bed to their permanent quarters, are either sown in narrow rows, or broadcasted. Such beds should not be enriched with manure to such an extent that the seedlings are excited into rapid growth, neither should they be "hungry", or without a reasonable amount of plant food in the form of humus, or decaying vegetable matter, such as thoroughly decomposed leaf-mould; which, apart from supplying nourishment to the plant, provides a good rooting medium. Seedlings must never be allowed to remain in the bed until they become stunted or starved, the stems appearing tough and wiry in texture; as, like half-starved and hide-bound store cattle, they are not easily induced to repair or make good the damage which they have sustained through lack of nourishment.

Seedlings of plants like carrots, beetroot, and parsnips, which do not admit of transplanting, must be thinned out as soon as opportunity affords, and, for preference, after rain or during showery weather. Where late thinning is practised, or the plants are allowed to become crowded, considerable injury will be done to the remaining plants. All plants of the Brassica tribe succeed better when transplanted, although some sheep farmers prefer to drill their cabbage seed.

**Sowing and Planting.**—The time of year at which different plants can be sown depends upon a variety of circumstances, chief among which are aspect, climate, and soil. Where the ground is sheltered from cold winds from the east and north-east, and slopes towards the south or south-west, and is naturally drained, it is possible to sow seeds of peas, and broad beans in November, and again in February, as, when they stand the winter, hardier plants are obtained than is possible from spring sowings. This is very essential in the case of broad beans, as the hardier the plants, the better will they resist the attacks of black fly (*Aphis rumicis*). Early potatoes can be planted in warm borders in February, where lettuce and other saladings may also be transplanted or sown. Cauliflowers may be set out in May, turnips may also be sown in February, to be followed later by carrots. These methods are unattainable on soils of a heavy, cold, and tenacious character, having a north or north-east aspect.

The student must observe carefully all these variable conditions, think out possibilities for himself, and be largely guided by local conditions. The months of March and April afford the best opportunities for sowing the great majority of garden vegetables, as the soil is then sufficiently dry on the surface to admit of its being forked over, and raked down to a fine tilth, without becoming kneaded into a dough-like mass at or below the surface. Seedlings, like those of the beetroot, which are susceptible to frost must of course be sown later, say in May, when there is little or no risk of growth being retarded, or delicate seedlings being frozen.

Successive crops can be sown from spring onwards, at the discretion of the cultivator, who must carefully consider the time required for any crop to attain a condition of usefulness, if not of maturity. Peas, for example, are often sown late in the hope of securing gatherings in September, but usually these late sowings fall a prey to mildew, or, should they survive this, or other disease, very few pods are forthcoming and may only contain a few partially developed peas. Thus it will be seen that no hard and fast rules can be laid down as to when any particular crop should be sown.

The distance apart at which to sow seeds, or transplant seedlings, must be governed by the size or dimensions to which it is estimated that the plants themselves will attain, making provision for a free circulation of light and air around each individual plant; greater space being given between than in the rows, to facilitate cleaning operations.

**After-cultivation.** — After-cultivation is a term implying that attention, which is necessary from the time a seedling appears above ground, or is transplanted, until the time of maturity or harvesting.



It consists, principally, in hoeing, to prevent the growth of weeds, and to conserve moisture; and, when necessary, for supplying water to the roots, in order that the plants may not unduly suffer during a temporary or prolonged drought, or in blanching, as in the case of celery and many salads. The treatment of the plant in combating insect and fungoid diseases is directly connected with after-cultivation.

If the student wishes to study in detail the more intricate methods which attend the forcing of vegetables, or their production for exhibition purposes, he should consult such books and writings on the subject as are written by men possessed of sound practical experience, as it is only by growing the various plants that he can become acquainted with their individual merits and requirements.

**Manuring for Vegetables.**—Carrots, parsnips, beetroot, and also potatoes, produce heavier crops of better quality if the soil was manured the previous year. As with farm crops, the best results are obtained when "artificial" are used in conjunction with farm-yard manure. Spring cabbage, cauliflowers, broccoli, and plants of like character respond well to dressings of yard manure up to say 10 tons, supplemented with 5 cwt. superphosphate, or 8 cwt. basic slag, 4 cwt. kainit, or 1 cwt. sulphate of potash, and from 3 to 4 cwt. of nitrate of soda per acre; or, instead of nitrate of soda, an equivalent dressing of some other nitrogenous manure, such as sulphate of ammonia, or nitrate of lime, may be used. These quantities must be regarded as only approximate, but the student will observe that they exceed those advocated for farm crops. Most market gardeners give even more liberal dressings, while for root crops grown on farms equally heavy dressings are sometimes given in order to secure large heavy roots for show, a practice which serves little economical use. Cereals cannot be manured above a given point without injuring the quality of the grain and incurring the risk of the crops becoming "laid"; but with plants grown for their foliage, such as cabbage, sprouts, sprouting broccoli, etc., liberal manuring is essential.

Mistakes are often made in over-manuring peas, with the result that the plants produce an excess of haulm at the expense of well-filled pods.

In digging out trenches for celery, care must be taken to avoid bringing inferior subsoil to the surface, as when young plants are placed in this, it is practically impossible for them to grow with freedom. Celery requires a continuous supply of moisture at the roots, and occasional feeding with manurial stimulants, until the plants have attained to a considerable size. There is no more rapid road to successful cultivation than for the student to make himself familiar with the habits of the plants he intends to cultivate.

The feeding of plants which are approaching maturity is a mistake. Immediately a plant has attained its maximum growth, and is possessed of a wealth of healthy foliage, all feeding should cease. To return again to the onion, it will be noticed that the plants produce long tubular leaves, which towards the end of July begin to turn yellow at the tips, showing that the plants are approaching the resting stage; the leaves have manufactured and stored the materials for

the development of their bulbs, and their gradual discoloration indicates that this concentrated food material is passing down to the bulb in order to build up the fleshy scales of which it is composed. Meanwhile the root fibres, which are of annual duration, become inactive and, like the leaves, finally decay, leaving the bulb complete in itself, a mass of stored-up useful material for human food, which, if left to nature, would in the following season be further developed in the production of flowers and seeds, or in other words in the reproduction of the plant.

[The common practice of turning down the tops must be affected by the above considerations.—ED.]

This illustration merely serves the purpose of impressing upon the student the necessity of observing Nature as a guide to what should be practised in the cultivation of plants.

#### MARKETING OF FRUIT, FLOWERS, AND VEGETABLES.

The preparation and packing of fruit, flowers, and vegetables for market, is highly important. It will be invariably noticed at Covent Garden and other large market centres, that the most neatly and tastefully packed consignments of well-graded produce realize better prices than the badly packed and ill-graded lots, even though the latter be of really better quality than the former. The student is advised to get into touch with market growers, and study their methods if he can. A lesson may also be learnt from the Colonial and foreign produce, from Canada, New Zealand, Tasmania, France, and elsewhere; although of late years English growers have certainly improved wonderfully in their methods, and their fruit is packed quite as well as the best Californian produce.

**Packages and Materials.**—Nearly all fruits lend themselves admirably to grading, and considerable advantage is gained even if only the small or defective specimens are discarded. As a rule, first and second grades can always be made, and very often three can be separated with advantage. Colour plays an important part in this connexion, as well as size. In large establishments special machinery is employed for grading all fruits, except perhaps the choicest and ripest samples. A light, spacious packing-shed is required in any case, with a few trays for sorting out the fruit, and some tables with rims at the edges. As regards the packages, strong durable willow baskets of various sizes, from a bushel or "sieve" to a "half-sieve" or pack, are commonly used. In Worcestershire, a tall square basket, known as the "pot", is used for plums (a pot holds 72 lb. of plums) and various vegetables and even for flowers. The flat, square basket is, however, a more popular form in many parts, for anything except flowers. Choice fruits, grapes, and tomatoes, etc., are often packed in white willow-handled baskets; "baby baskets" of the same type being commonly employed for the best quality English grapes. For vegetables, such as cabbages, cauliflowers, etc., wooden crates about 3 or 4 feet high are most common, and for strawberries the ever-popular "chip" is nowadays essential. Flowers, and the lighter vegetables and salads, can be very safely

packed in light, non-returnable boxes  $10\frac{1}{4}$  by  $7\frac{1}{2}$  by 3 inches deep to  $21\frac{1}{2}$  by 14 by 7 inches deep, which cost from 2*d.* to 5*d.* each.

Any kind of box, used for sending produce to market, must be as light as is consistent with strength and durability, cheap in proportion to the value of the produce carried, and non-returnable, or, if returnable, fitted with strongly-hinged lids. Wood-wool, or very fine wood shavings, is the best material for ensuring firmness in the contents of the package, keeping them fresh, and preventing any damage. To protect the produce from dust, tissue paper of various tints or colours is useful and effective. Various accessories for packing, bunching, etc., include paper shavings, shredded paper, fresh and dried moss, bracken fern, willow shoots for tying radishes, etc., good manilla cord for securing boxes of heavy fruits, raffia or "raffia tape" for bunching flowers, etc.

**Fruit.**—Large choice apples and pears must be very carefully handled, each fruit being first wrapped in tissue paper, and then placed singly in position in shallow boxes, holding one layer of from twelve to twenty-four fruits; or a thin band of tissue paper may be rolled round each fruit. Wood-wool is placed at the top and the bottom of the box. Large consignments of early apples are packed in similar fashion, and the boxes are placed in crates, one on the top of the other. The firmer-fleshed apples are sometimes packed in small barrels, above a layer of wood-wool, with a sheet of paper between. The top is then laced over with cord, and the fruit is covered with bracken fern. In times of glut, plums are best sent direct to jam factories in "half-flats" of 24 or 28 lb., each basket being lined with strong white paper, large enough to admit of its being folded over the fruit when the basket is full. Coarse wood-wool is then placed on the top. Choice wall plums are displayed to the best advantage in punnets, in single layers; the bulk of the fruit being packed in half-bushel baskets, and the showy Victorias, and large greengages, in pecks of about 12 lb.

Cherries are usually packed in half-bushels of 24 lb., and pecks of 12 lb., the large soft varieties like Napoleon and Elton in pecks, and the Morellos in chips. Early gooseberries sell best in 6 lb. chips, later sorts in pecks of 12 lb., and half-bushels of 28 lb. Special dessert fruits are best packed in punnets of 1 lb. Punnets are most suitable for packing dessert raspberries, six or twelve being packed in a single box, and cooking cherries in non-returnable chips, holding from 4 to 6 lb. Strawberries give more trouble as regards packing and marketing than any other fruit. The introduction of light, smooth, and non-returnable chip baskets has, however, gone far to solve the difficulties, and the best type of basket is the square variety, with flat wooden handle, which can be easily branded with the name and address of the grower or sender. These may hold anything from 4 to 6 lb. of fruit. If the berries can be sent to market by road, they should be packed in punnets of 1 lb., placed in boxes holding a dozen or two dozen punnets.

**Vegetables.**—Most vegetables lend themselves admirably to bunching, but of late years it has become more customary to send colewort heads and cabbages to market in bushel sieves, instead of in

the form of bunched greens ; and another practice that is fast falling into disuse is that of loading vegetables loose upon vans. Radishes are expensive roots to prepare for market ; the turnip-rooted kinds are usually tied in round bunches of from two to three dozen roots each, while the earlier large-rooted sorts, are tied in flatter bunches. Turnips and carrots, of even size, are bunched in dozens or two dozens, care being taken to tie the bunch so that the roots are all on a level.

Celery and leeks look very well indeed when carefully washed and bunched. Only the best celery sticks are tied in flat single- or double-layer bundles, eight to sixteen or twenty sticks to the bundle, and the heads should be trimmed and cleansed first, and placed flat side upwards. Soft willows are used for this vegetable and also for leeks, the latter being bunched in dozens or more. Asparagus is sold in bundles of 25, 50, or 100 stems, the latter being a "full" bundle. In some parts small bundles of twenty stems are made first, and half a dozen of these tied into a large flat market bundle, tied with a single willow band. As a rule, it is safest to pack asparagus in flat-lidded baskets. Seakale looks well in flat-spreading bundles, when the heart and stalk are fully shown, the bunches being placed in a slanting position in plaited baskets, and the base of the stems wrapped in a little soft tissue paper.

Flowers.—Most flowers, particularly chrysanthemums, dahlias, daffodils, marguerites, narcissi, sweet-peas, wallflowers, mignonette, violets, etc., are best bunched, or made up into sprays. Some are garnished with their own foliage, violets especially, and a market bunch of these blooms will vary in size according to the scarcity or abundance of the supply. Small bunches are made for retailing, and large ones for market work, the latter being afterwards broken up into smaller bunches to suit a particular class of trade. Bunches of any of the above-mentioned cut flowers are most conveniently packed and marketed in dozen bunches in shallow boxes, lined with tissue paper, and fitted with tight-fitting lids, so as to prevent excessive evaporation of moisture.

Some flowers, such as roses, tuberose, orchids, winter-flowering carnations, forced lilies of the valley, Roman hyacinths, narcissi, tulips, etc., are packed loosely, and sold at so much a dozen trusses, blooms, or spikes, as the case may be. Tulips, narcissi, and other bulbs should always be decorated with as much of their own foliage as it is possible to obtain. All bunched blooms are best put up in separate shades or colours. Ornamental foliage such as *Asparagus plumosus*, *A. Sprengeri*, crotons, adiantum, ferns of various kinds, smilax, *Quercus rubra*, oak, beech, chestnut, carrot leaves, and variegated ivy, are also usually marketed in bunches. In packing very large flowers, such as the spikes of *Lilium auratum*, *L. Harrisii*, etc., deep boxes should be used, and the stamens of the white or lighter-coloured blooms removed, so as to prevent the discoloration of the petals by the shedding of pollen.

## CHAPTER IV.

### PLANT DISEASES.

WHEN plants or animals are reared under artificial and intensive systems, disease or diseases begin to make their appearance, and sooner or later contribute to the death of the plant or animal affected. In-breeding, or the mating of closely related individuals, is largely conducive to delicacy or weakness of constitution, accompanied with disease, as instanced in the case of thoroughbred horses, foxhounds, and wherever close-breeding is practised.

The florist knows from experience that as soon as a wild flower, naturally inheriting a strong robust constitution, is taken in hand by the hybridist, and grown under more intensive and altered conditions with a view to producing large flowers, or a greater wealth of seeds or fruit, disease becomes more prevalent than under natural conditions. Often the cellular structure of the whole plant is altered physically and chemically from what it originally was. So firmly established do some of these diseases become, that the cultivation of certain species and varieties of plants has even been abandoned.<sup>1</sup>

Modern science and research have contributed largely towards a better and more thorough knowledge of plant diseases, thereby enabling the cultivator to combat them by arresting or even destroying the spores of the disease in its early stages.

The horticulturist knows too well how troublesome are such plant diseases as rust in chrysanthemums and carnations, powdery mildew in the vine, leaf curl in the peach, and many others too numerous to mention.

As this is an agricultural rather than a horticultural textbook, we must restrict attention to those diseases which more directly affect the farmer and market gardener, although there are some which are common to all cultivations.

The potato is by far the most important vegetable crop grown in these Islands, and wherever a plot of ground is set aside for domestic purposes potatoes receive first consideration. Sound constitution is one of the most desirable qualifications of a good potato; and those leading nurserymen, who have done so much to introduce new varieties, and to improve those already in cultivation, have always to bear in mind that while combining early maturity and quality, yield and disease-resisting power must also be considered.

As the potato continues to be propagated from tubers, and not from seed, year after year, so does its constitution become impaired, and

<sup>1</sup> Similarly it is now generally allowed that diseases which affect human beings are for the most part associated with civilized communities.

the more so when grown in the same or similar soils and climatic conditions. It is largely for these reasons that many plants derive benefit from a change of soil and climate, or as farmers call it a "change of seed". The same remarks apply to ourselves; how often does a change of air, and we may even say of soil, from a low-lying moist district, where the soil is heavy and tenacious, to a district of high elevation, on say either chalk or gravel, improve the health of those whose constitutions have become "run down", and who are thus rendered more susceptible to disease.

We have also to consider the chemical constituents of which seeds are composed, and to what extent circumstances will influence their vitality and strength of constitution. Over-ripe or fully-matured potatoes contain an excess of starch, and are not so vigorous as less matured tubers, which contain more nitrogenous matter in their tissues.

A similar condition is noticeable in barley; as the best malting samples may be compared to bags of starch, and lack the vitality of coarser samples often described as feeding barleys. These have a higher nitrogen content, and, like the waxy or un-matured potato, are not so likely to fall victims to disease.

The process of depopulation by disease, or, in other words, the "survival of the fittest", is continually going on among animals and plants, and the more so as conditions of living become more intensive and strenuous.

Insect and vegetable pests play an important part in the destruction of living cells, and, belonging to the latter class, we have fungi and bacteria, both of which are devoid of chlorophyll. Chlorophyll, it will be remembered, is present in all green leaves, which are veritable starch factories.

Fungi vary enormously in shape and size, and are made up of masses of fine threads or filaments, which may be arranged loosely like cotton-wool, as in moulds, or agglutinated together, as in the edible mushroom. Reproduction or "seeding" is carried on by the formation of small globular spores on the ends of some of the threads or filaments. These spores under suitable conditions are capable of growing into plants, exactly like their parents. Fungi are unable to live on mineral foods and carbon dioxide like green plants, but must have organic food such as is found in the tissues of living or dead animals and plants. Those which derive their food from dead matter are termed "saprophytes", while "parasite" is the term applied to the fungi found on living bodies. It is the latter class with which the farmer has mostly to contend.

Bacteria (Fig. 4) are minute plants most nearly allied to the fungi. They are the most minute living things known, and in shape are like small dots, spheres, rods, or short spirals. They are responsible for many diseases of both plants and animals.

**Club Root or Finger and Toe.**—This disease (Fig. 289) attacks most, if not all, cruciferous crops, and is due to a fungus. Plants affected with this disease have misshapen roots, which on being cut open are more or less brown where they ought to be white, and, later in the season, they become rotten, and emit an objectionable smell.

Spores are produced, and these may be present in the soil in winter. If a crop is sown in the following spring, or even if cruciferous weeds abound, the spores burst, and a small germ of living matter escapes, capable of moving about among the moist soil particles. Upon reaching a young plant, the germ enters the root-hairs, or other tender portion of the root, and lives on the substance of the cells, breaking down the cell-walls and producing a dark discoloration. Eventually the jelly-like matter develops minute round specks or spores, and as the root breaks up these are spread in the soil, where they may remain quiescent for a year, or longer.

Acid and wet conditions of the soil are favourable to the development of the disease, and it is rarely found in soils containing plenty of lime. To prevent the disease, burnt lime should be applied at the

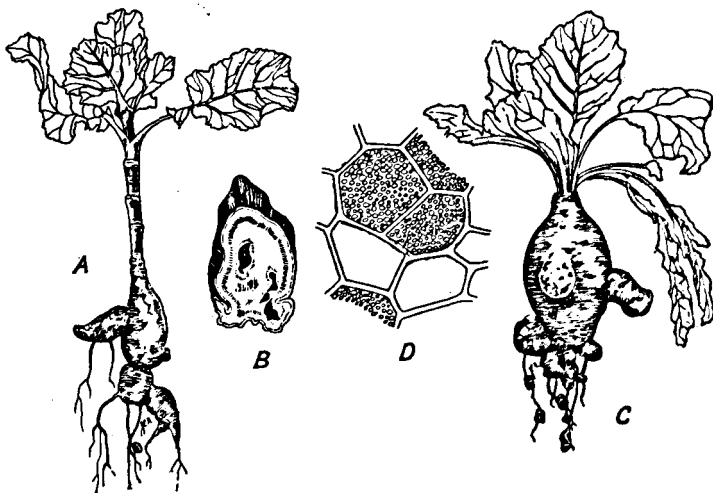

FIG. 289.—Club Root or Finger and Toe (*Plasmodiophora brassicae*). A, diseased cabbage plant; B, section of diseased root; C, diseased swede; D, cells of root abnormally enlarged and containing spores of the fungus.

rate of from 5 to 7 tons per acre, six, or preferably eighteen months, before a cruciferous crop is grown. Acid manures such as superphosphate and dissolved bones should not be applied, if the land is liable to "club root", but basic slag, bone meal, or precipitated phosphate may all be used.

Cruciferous weeds, such as charlock and shepherds' purse, should be eliminated. Working the land when out of condition is also liable to encourage the disease, and as an instance of this it may be noticed that finger and toe is often prevalent on the headlands which are especially trampled by horses. Drainage helps to keep the disease in check, as the sour condition produced by wetness is favourable to its development. If land is liable to this disease, cruciferous crops

should be kept as far apart in the rotation as possible, e.g. potatoes and mangels may be grown alternately instead of swedes and cabbages, thus doubling the period between the latter crops.

**Black Rot of Cabbages, Turnips, etc.**—Luckily for the British farmer this disease is not very prevalent in this country. It is of bacterial origin, and causes the plants to rot. All cultivated plants belonging to the natural order *Cruciferae* are liable to the attack, but in this country rape seems most susceptible to the disease. The leaves are first attacked, and later the stem is involved.

**Mildew in Swedes, Turnips, Rape, etc.**—The mycelium of this fungus spreads over the whole plant, and “spores” are produced in enormous quantities. Badly affected plants may give off a putrid odour, and a mushroom-like smell is generally apparent when the leaf is rubbed. Early-sown swedes are most susceptible, especially when grown on soils which become parched during dry hot seasons. If swedes have grown rapidly, and have then received a sudden check, the mildew is almost sure to appear, and it is for this reason that swedes in some districts are not sown until the second week in June. Repeated hoeings will stimulate growth, and help the plants over critical periods when mildew attacks are prevalent.

**Heart Rot in Mangels and Swedes.**—This fungoid disease is not very common, and usually does not appear until the middle of August. The leaves when first attacked appear to wilt. Later, the mycelium of the fungus passes down into the crown of the root, spreads, and causes blackening, and, finally, the entire tissues are reduced to a decaying mass. Yellow mangels are said to be more susceptible than red. Little can be done beyond the removal and destruction of all diseased plants.

**“Rust” and “Mildew” in Wheat.**—A wheat crop in the early summer may rapidly lose its green colour, and become yellowish in a few days, if suffering from this disease. Reddish spots or patches on the leaves and stems may be seen, from which an orange-coloured powder is shed. This powder represents millions of summer spores or uredospores, which may be blown on to other wheat leaves, and such infected leaves in their turn become “rusty”. This goes on throughout the summer, but, on the approach of autumn, a different kind of spore is produced, namely winter “resting” spores, or teliospores. These are brown or black in colour, and the wheat is then said to be mildewed. “Mildewed” straw never exhibits the shining golden colour of healthy straw, but is greyish-brown, and dirty in appearance. These resting spores, which remain dormant during the winter, germinate in the spring, and produce several basidiospores, which may be blown on to the leaves of the barberry plant. When this happens, each spore sends a thread into the leaf; the thread or filament branches, and soon forms a network of fungus threads within the leaf, around the centre of infection. After a time the skin of the barberry leaf is broken open by the inflorescence of the underlying fungus, which in the meantime has been forming great numbers of aëdiospores, or spring cluster cups spores. When the leaf skin or epidermis ruptures these escape, and each spore is capable of producing “rust”, provided it is blown on to the leaf



of a wheat plant. Here it will germinate, and, after sending filaments into the centre of the leaf, grows, and eventually produces uredospores, as previously described. Thus the vicious cycle is completed.

Rust or mildew can therefore produce four different kinds of spores, all having definite functions and forms. Many scientists, who have made a study of this disease, are of opinion that these different spores do not satisfactorily account for the spread of the disease. They consider that the disease is hereditary, that some of the fungoid filaments enter the seed, lie dormant during the winter,

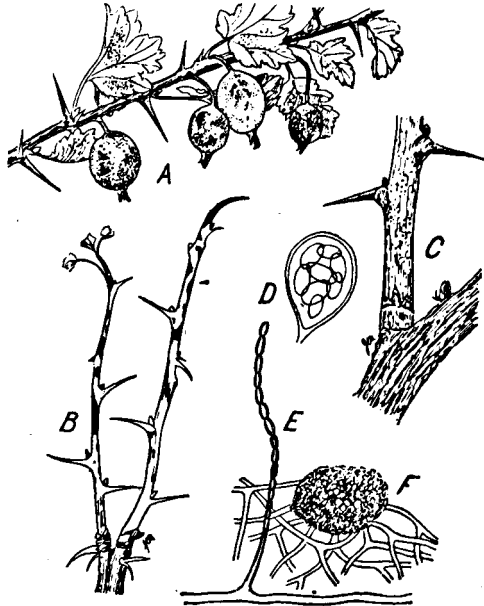

FIG. 290.—American Gooseberry Mildew (*Sphaerotheca mors-uvae*). A, diseased berries; B, winter condition of shoots of green-fruited gooseberry; C, winter stage of disease showing black winter fruits (perithecia) enlarged; D, sac (ascus) with spores; E, conidia of mildew stage; F, perithecium with mycelium.

and commence growth when the wheat germinates. We, however, know that as yet no preventive measure has been discovered to combat this disease; but the production of immune varieties of wheat seems to offer a hopeful solution of the difficulty. It is to be noted that the fungus does not *directly* affect or injure the grain; but by damaging the leaves and stems, or, in other words, the starch factories of the plant, as well as by absorbing large quantities of the food which has been collected in the plant tissues, the fungus is ultimately responsible for the starving of the grain, and a diminished yield.

**Gooseberry Mildew.**—Two forms of gooseberry mildew occur in Britain, namely, *Microsphaera grossularia* and the more recent introduction, the American *Sphaerotheca mors-uvæ*. The life-history of both species is somewhat similar, but they differ in structure, the latter being considerably more injurious than the former. When attacked by the American gooseberry mildew (Fig. 290) a greyish-white mildew appears upon the green parts of the plant producing summer sporules as chains of conidia, which are easily dispersed and rapidly spread the disease. Later in the year the patches darken owing to the presence of myriads of black or brown ascus fruits, others remaining on the plant.

**Bunt of Wheat.**—The fungus producing this disease is harmful, as when the wheat plant matures it converts the grains into kernels consisting mainly of fungus threads and spores (Fig. 291). The

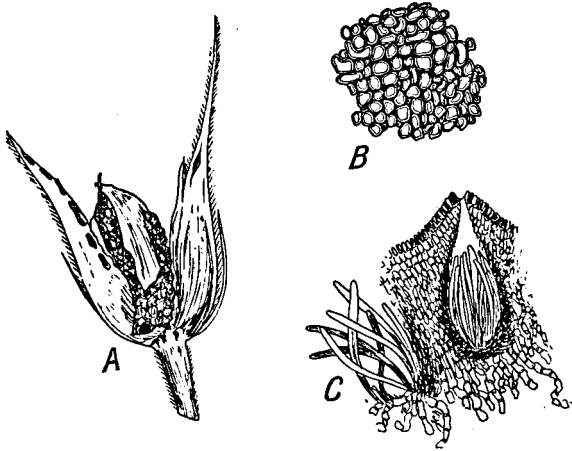

FIG. 291.—Bunt or Smut (*Ustilago*). A, affected ear; B, spores; C, germination of spores.

latter are not shed in the field; but in harvesting, threshing, and winnowing, the outer cases are broken and the mass of dark-coloured spores is released and scattered broadcast, so that healthy seeds become contaminated. In milling, moreover, bunted wheat communicates an objectionable colour as well as a fishy smell to flour.

It is possible to detect diseased plants in the crop, as the leaves are of a deeper green than those of healthy plants, and when the wheat is in bloom, the chaff-scales open out more widely and remain so throughout the season. Infection takes place in the seedling stage. The spores, which are adhering to healthy grains, germinate, produce filaments, which also produce other spores, and these germinating in turn, send their filaments through the stomata of the young

seedling. The fungal threads then extend up the wheat plant and do no apparent harm until the plant is mature.

Pickling the grain with copper sulphate, or steeping in formalin, kills the spores before they do any damage.

**Loose Smut in Oats.**—The presence of this fungoid disease in the oat crop cannot be detected until late in the season. When the plant flowers and the grain begins to form, a black powder seems to take the place of the healthy ear, and no grain will then be obtained. This powder or dust consists of millions of spores, formed by a fungus, which has remained parasitic in the oat plant ever since it was a seedling. No outward evidence of its presence can be detected until the fruiting stage. The black dust is blown about in the field, and spores thus become lodged on the skins of healthy grains formed on other oat plants in the field, and will adhere until these oats are sown the following spring. The fungus spores germinate, and are ready to enter the tender shoots of oats just below the ground and proceed up the stalk as they elongate. No mould is to be seen on the stalk, nor does it appear abnormal when split open; nothing is seen of the fungus until it fructifies, and at that stage all the store of food that the oat plant has prepared for the formation of grain is utilized by the parasite.

Pickling or treating the grain with a dilute solution of copper sulphate, or formalin, has been found to kill the smut spores without injuring the seed.

**Loose Smut of Barley.**—Like the loose smut of oats, this disease is caused by a fungus, the presence of which is not evident in the early stages of the plant's development. By the beginning of June, however, the affected plants may be easily seen in a field, and are more forward than the healthy plants. Their heads stand erect, while those of their healthy companions are still drooping, and the dark colour of the fungus spores shows through the chaffy scales. Practically the diseased plants can be detected at from twenty to thirty paces. Happily at this stage not a single spore will have escaped, so that if the plants are uprooted, and the diseased heads cut off and removed, infection of the healthy plants will not take place. On the other hand, if they are not removed from the field the black dust becomes dry, in a week or two, and is blown about the field. The healthy barley plants, not being so far forward, in fact only being in the flowering stage, are infected internally. It was at one time thought that the fungus attacked the barley in the seedling stage as in oats, but evidence since obtained favours the above view.

From these details it will be seen that "pickling" will not eliminate this disease, and that the farmer must obtain his seed from a source which, in the month of June, was entirely free from it. If weeding out the diseased plants is performed at all it must be before any spores are liberated. It is also noteworthy that if there are, say, three stalks growing from one barley grain, and one of them is diseased, the others will be diseased.

**Loose Smut in Wheat.**—The description given of the loose smut in barley applies to the same disease in wheat, and infection takes place at the flowering stage.

"Pickling" does not prevent the disease appearing, if the seed has been obtained from a smutty field. It is easy to detect, and the infected plants may be weeded out, as in the case of affected barley.

**Potato Disease or "Blight".**—This is probably one of the most common diseases met with on the farm. During wet sultry summers potato plants frequently exhibit yellowish patches on their leaves, a slight mouldiness also becomes visible on the under-surface, and,

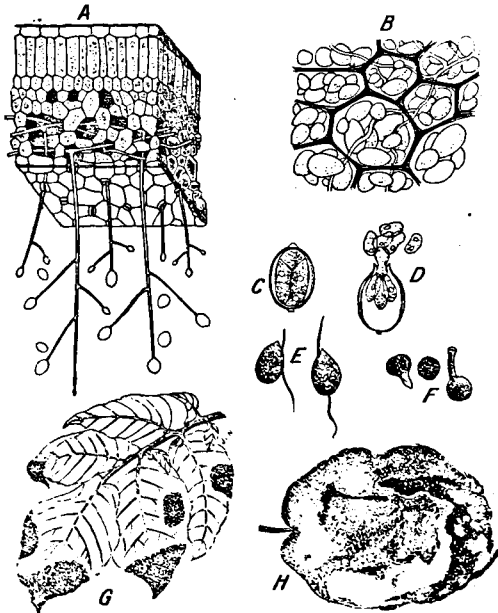

FIG. 292.—The Potato Disease (*Phytophthora infestans*). A, section of potato leaf showing spore-bearing branches growing through the breathing pores on the under-surface of the leaf; B, showing fungus feeding on starch in diseased potato; C, conidium spore in water with the protoplasm divided to form zoospores; D, the zoospores escaping from the apex of the conidium; E, the zoospores in motion; F, the zoospores which have ceased to move and are beginning to germinate; G, under-surface of diseased leaf; H, section of diseased potato showing destruction of tuber.

by and by, the leaves and stems rot away. Potato blight is highly contagious, and under favourable conditions will spread rapidly. A distinctive animal odour accompanies the "blight", and when once experienced enables anyone to diagnose the disease on future occasions.

An infected tuber (Fig. 292), and this is probably the chief vehicle by which the disease is carried on from year to year, shows

brownish patches when cut across. If these brown patches are examined, the cells will be found to be partly broken down by fungal threads, passing through, and between them. If such a tuber is planted, and the summer proves wet and sultry, the fungus passes up the stem, without doing much apparent damage, and, passing into the leaves, forms a large number of threads, which completely ramify through the leaves, absorb the food stored in them, and cause the death of the cells, and a yellowing of the leaves. The ultimate branches of the fungus pass out by the leaf stomata, and each branch forms several side-shoots, on the end of each of which a spore forms. These spores are set free by the least breath of air, and are carried to neighbouring potato leaves. If sufficient moisture is present on these leaves, the spores burst, and a number of smaller spores, each provided with a pair of cilia, escape into the adherent water. By the movements of their cilia these spores spread over the leaf, and ultimately settle down, grow tubes, and pass into the leaf, which soon succumbs as before.

Spraying potatoes with Bordeaux Mixture, or Soda Bordeaux, has been attended with very satisfactory results. Great care must be taken in the preparation of these sprays, and both sides of the leaves of the plant must be reached. These mixtures cannot of course affect the fungus inside the plant, but they kill the portion which comes to the surface, as well as the spores which spread from plant to plant. Moreover, the mixture has a tonic effect on the plant, and causes the crop to continue in a healthy condition longer than if not sprayed. Since the leaves are the factories for the production of starch, the yield per acre will naturally be considerably increased if the plants remain green instead of dying, or rather rotting down, prematurely.

**Winter Rot of Potatoes.**—When the tubers are stored, it often happens that a large number of them are found to be rotten when the clamp is opened. The rotten tubers easily break when touched, and a watery evil-smelling liquid exudes. Some of them have white mould growing from the rotten parts, or, instead of being perfectly white, the mould has a tinge of pink or purple. The cause of this disease is a fungus, and probably a large number of the tubers are infected when put in the clamp, and, if the potatoes are not thoroughly dry, the disease makes rapid progress. The spores which are formed on the ends of the woolly tufts are distributed by mites and small insects moving about amongst the tubers in the clamp. It has been noted that the worst attacks take place after a hot, dry season. The tubers become infected in the soil when they are quite small, and land which has produced a crop of potatoes so affected should be dressed with kainit or lime, both of which destroy the spores. Aeration, or ventilation of the potato clamp, is most important, and if sulphur is thrown among the tubers at the rate of about 2 lb. per ton, it exerts a beneficial effect.

**“Scab” in Potatoes.**—Potato scab is merely superficial, and does not impair the quality of the tuber to any serious extent. The market price, however, is depreciated when scab is at all extensive. The fungus usually attacks the tuber while young, forming scattered

rough patches on the surface, which gradually increase in size and number.

The disease is carried in the "seed", and the soil may also become infected. If contaminated sets must be used they should first be steeped in formalin. Lime tends to discourage the fungoid attack, and acid manures should be applied to infected land. The same disease also attacks beet, swedes, carrots, and cabbages, but not cereals.

Wart Disease or Black Scab (*Synchytrium endobioticum*, Percival) appears in the form of swollen, warty, excrescences on the tubers (Fig. 293), which contain the spores of the fungus responsible for

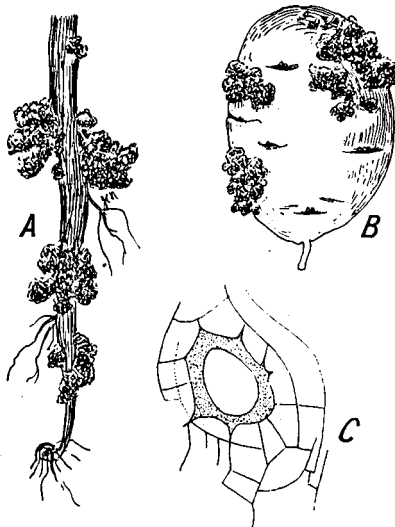

FIG. 293.—Wart Disease of Potatoes (*Synchytrium endobioticum*, Percival); recently known as *Chrysophlyctis endobioticca*. A, stem affected with disease; B, diseased tuber; C, spore-bearing cells.

the disease. These spores are capable of infecting healthy potatoes, and may exist dormant in the soil for years. The disease is somewhat analogous to finger and toe of turnips, and the most drastic measures in the matter of dressing the land with gas-lime, and burning all infected portions of haulm, are necessary. Diseased tubers must on no account be allowed to lie about, but should be cooked as soon as possible. Infected land should be given a rest from the potato crop for at least eight years.

**Clover Sickness.**—In fields of clover we sometimes notice that patches die down, the affected areas gradually increasing in size, so that the crop is often much damaged. This ailment is known as

"clover sickness", but the above symptoms may also be due to either an eelworm or a fungus. They are often associated together, but the disease may be due to the attack of one or other cause.

The fungus causes the leaves to turn yellow and die down. Early examination with a lens shows the presence of fungal threads, and, when the disease is further advanced, small black nodules may be found on the dying or dead plants. The fungus threads spread from plant to plant, and the diseased patches rapidly enlarge, until the whole crop may be involved. Later on, these nodules, which are really masses of filaments, produce spores which are set free, and may infect plants some distance away.



FIG. 294.—Ergot (*Claviceps purpurea*). A, ergot-infected timothy grass; B, ergot-infected wheat; C, ergot-infected rye.

Kainit and lime are recommended as dressings, but when a field has suffered from clover sickness it should not be sown with the same crop again until after a considerable interval of time (see Rotations).

The other cause of sickness in clover, the stem eelworm, is a nematode or thread-worm, of microscopic size. Some of these worms are parasitic, and others non-parasitic, and the former have a piercing organ in their mouths. The eelworms lay eggs in the plants which they infect, and both worms and eggs are extremely

tenacious of life. In fact, eggs which have been kept dry for months will hatch when placed under moist conditions, and young worms which have been dried up even for years will revive under suitable conditions.

Sulphate of potash applied at the rate of from 3 to 4 cwt. per acre is found to be an effective dressing ; and as wheat, beans, oats, onions, etc., are also attacked by this pest, it is very important to eradicate it.

**Ergot.**—In rye, wheat, and many pasture grasses, dark purple-coloured bodies known as “ergots” are occasionally found (Fig. 294), occupying the place of the grain. In rye, and several of the grasses, these structures are much larger than the natural grains, and are readily seen as projecting horn-like appendages, while in wheat and some of the smaller grasses, they are the same size as the grains.

Each ergot is really an agglomeration, or mass, of fungus threads, which when cut open appear white and waxy in character. The substance of the ergot contains several poisonous compounds. Ergotism, or poisoning resulting from the consumption of ergotized bread, is now rare, but abortion in cattle is sometimes said to be caused by grazing on ergotized grasses.



## PART VI.

*POULTRY, RABBITS, AND BEES.*

## PART VI.

### *POULTRY, RABBITS, AND BEES.*

---

#### CHAPTER I.

##### DOMESTIC FOWLS.

POULTRY-KEEPING is a most important branch of farm economy. It gives rise to an endless amount of discussion, and anyone who wishes to specialize in it must study it in every detail. He should endeavour to acquire practical experience at the same time as he studies, in well-known poultry centres, such as Heathfield, in Sussex, or other places where the industry has been established for many years past.

**Commercial Poultry-farming.**—Egg-production is now specialized in by many commercial poultry-keepers in this country, and we have seen large areas of ground devoted to the rearing and management of special laying breeds of fowls, notably White Leghorns. We have also ample proof that abnormal returns have been secured. Needless to say much depends upon the site of the farm, light soil overlying chalk or gravel being almost essential to success.

Large "Mammoth" incubators of the hot-air type, with a capacity of 3,000 eggs, are employed, and when hatched, the chickens are removed to a brooder, 110 feet long and 12 feet wide, divided into twenty partitions 5 feet wide and 8 feet long, which contains 2,500 chicks. The brooder is heated with hot-water pipes, while the south side is practically all windows. Later the birds are removed to colony houses, and finally to their permanent quarters, consisting of a long shed 180 feet long and 9 feet wide, divided every 10 feet by a partition, and containing altogether 400 birds. These sheds are placed in the centre of the ground, and divided in such a way that the birds have access to the ground lying on the south side of the house from the month of October until March, while from April to September they are restricted to the north side.

Each acre of ground is usually split up into narrow strips in order to admit of its being occupied and cropped alternately. Thus, after the birds are removed, each strip is immediately ploughed up, and sown with wheat and thousand-headed kale, as a means of keeping the soil sweet, and providing food for the birds. It is usual to stock one acre with a flock of 400 birds.

The secret of success is economy of labour, and this is still further emphasized in the feeding of the birds. This consists of dry-mash feeding from hoppers, from the time of hatching onwards, while the houses are also provided with a continuous supply of fresh water.

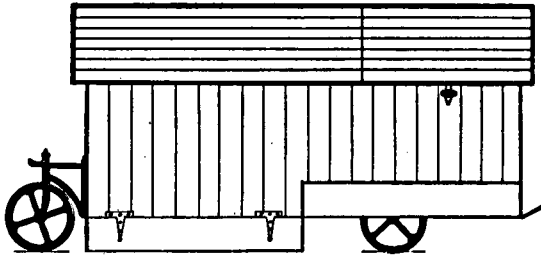

FIG. 295.—Portable Fowl-house on Wheels.

From the above remarks it will be seen that this system applies wholly to intensive poultry-farming, and is not applicable to the ordinary type of mixed farm.

The agricultural student need only devote his attention to the general management of poultry ; and questions of detail may well

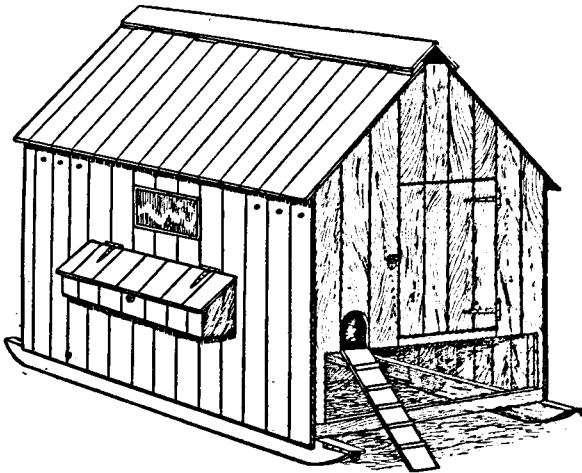

FIG. 296.—Portable Fowl-house on Runners.

be left until he has more leisure to go into them. In poultry-keeping, the use of portable houses is advisable. Many of these are built on wheels or sledge-like runners, and can be drawn on to the pastures or stubbles some distance away from the farmstead, without much

trouble. This gives the fowls an opportunity of picking up a large amount of natural food, and there is often a quantity of scattered grain on stubbles that has fallen to the ground during harvest. Poultry manure is not without its value; thus it may be observed that meadows which are stocked with fowls, and afterwards laid up for hay, yield a better crop than usual.

Thirty ordinary fowls, for example, will produce 1 ton of green manure in the course of a year, and assuming that 100 can be conveniently penned over an acre of ground, the manurial benefit must be of considerable value.

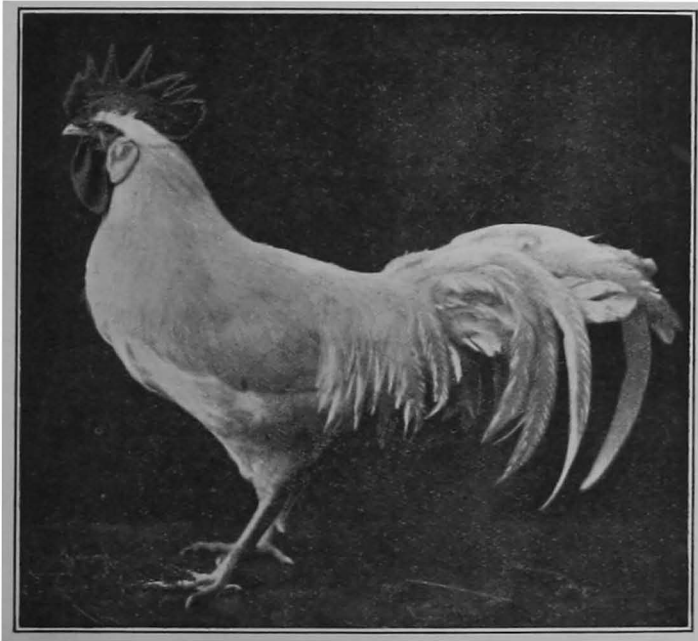

FIG. 297.—White Leghorn Cockerel.

**Equipment.**—The equipment necessary for a poultry-farm depends on the branch of the industry which it is intended to practise. The production of table fowls, for instance, necessitates much more "plant" than the production of eggs.

With regard to buildings, it is always preferable to use movable houses, on wheels (Fig. 295) or sledge-like runners (Fig. 296), so that they can be easily shifted about the farm. Houses built to accommodate about twenty to twenty-five birds, are the most suitable, as a rule. There may, however, quite possibly be buildings already existing on the farm, which can easily be converted into suitable fowl-houses, food-stores, or incubator rooms.

It is not desirable to keep a great many fowls round the farmstead, as the manure they make is more useful on the land.

Costly or elaborate accommodation is quite unnecessary. The object will be attained if the houses are strongly built, and, above all things, well ventilated without, however, admitting draughts. Further, they must be built in such a way that neither cattle nor storms will be able to damage them, or blow them over. Frequent shifting of portable houses is also a safeguard against rats, which soon find harbour beneath them. They, in fact, lose their meaning if they are allowed to remain too long in one place.

There is no hard and fast rule as to how many birds can be penned together in one house, as so much depends on the size of the house, and the ventilation. With plenty of ventilation a house 10 feet long, 6 feet wide, and 6 feet high at the ridge, with two perches

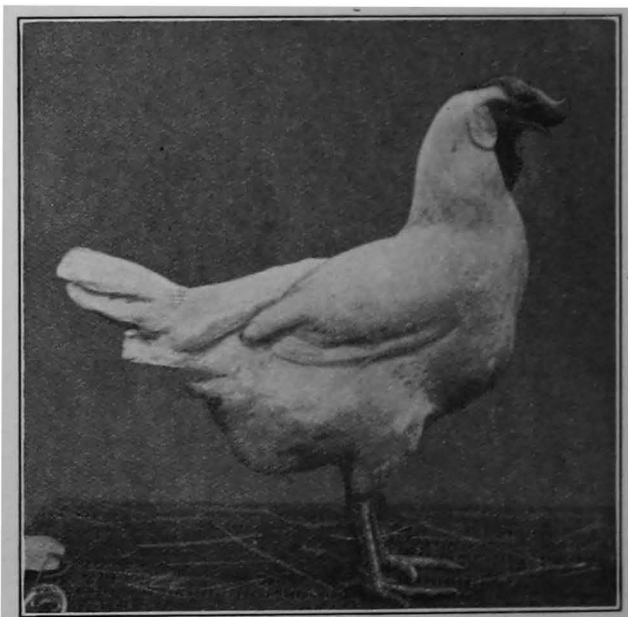

FIG. 298.—White Leghorn Hen.

running lengthways, will comfortably house twenty-five adult fowls. As a rule, it is the custom to allow 8 or 9 inches in length for each fowl on the perch.

Houses are better built without floors, so that the manure can drop to the ground, and labour is thus saved in cleaning, and there is no expense incurred in covering, or bedding down the floors. Where a large number of chickens are raised a good supply of sitting-boxes and chicken coops will be necessary.

*Sitting-boxes.*—These are required for hens that are incubating eggs. They are usually made to accommodate six hens, each in a separate compartment.

*Chicken Coops.*—These are used for the hen and her brood until the chickens are about six weeks old. The usual dimensions are 20 by 20 inches floor-space, 20 inches high in front, and 12 inches at the back. The coops must be fitted with night shutters and movable floors, and should be specially constructed so as to keep out rats and weasels.

*Chicken-houses.*—Several of these will be required. In the Sussex rearing districts, they are termed “hutches” or “night arks”. They are used for the chickens to sleep in from the time they leave the

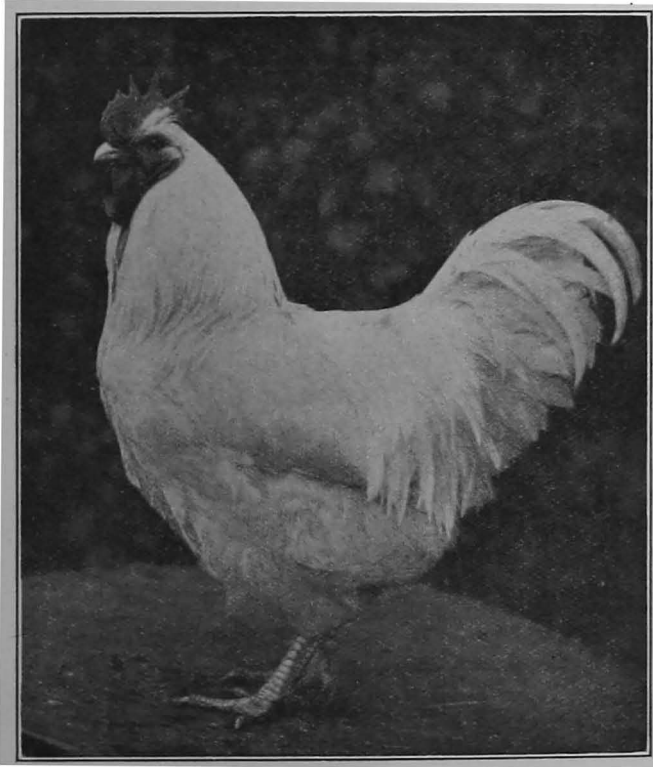

FIG. 299.—White Orpington Cock.

hen until they are drafted into the fattening coops, or permanent quarters for laying. These arks are usually made about 6 to 9 feet long, 3 feet wide, and 2 to 3 feet high, with plenty of ventilation at the top. They are generally built on legs so that the floor is several inches off the ground. The floors are made of spars of wood about 1 inch wide and placed about an inch apart, which allows the manure to fall through on the grass below.

*Crates.*—Several crates for broody hens are required for breaking them from sitting when not required for this purpose. Fattening crates answer well, and it will be necessary to have a considerable

number of them if fattening is to be undertaken. They are usually made about  $7\frac{1}{2}$  feet long, 18 inches wide, and 18 inches in height. Compartments are divided off in each crate, each being capable of holding from four to six chickens, according to size. The tops, sides, backs, and floors are slatted, and they should be placed under cover. For outside use they have a boarded back and roof, and are usually raised about 4 feet from the ground by means of posts or stakes.

*Cramming Machines.*—These machines will be essential for the finishing off of table poultry, which cannot really be properly prepared for market without.

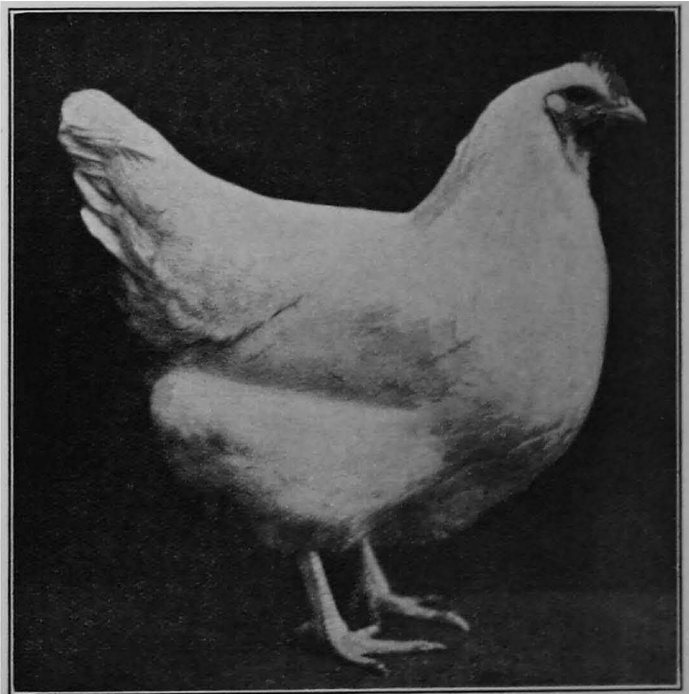

FIG. 300.—White Orpington Hen.

*Corn and Meal Bins.*—A number of these must be provided. Cheap ones can be made from large and strong packing cases, or paraffin casks, after they have been well burnt out. The same casks, cut in half, make useful tubs in which to mix soft food.

*Pails and Baskets.*—The former are required for water and the latter for carrying food and collecting eggs.

*Crates for Birds.*—A crate fitted for carrying on the back is very useful for moving birds.

*Egg-boxes.*—Several of these will be required, in different sizes, for dispatching eggs to market.

*"Peds."*—If many slaughtered fowls are sent away, "peds," as they are called in Sussex, will be the best form of package in which to dispatch them. They are light, strong, and very durable.

*Incubators.*—When a large number of chickens are reared early in the season, one incubator or more must be provided. Of these, the most useful are capable of normally holding 100 eggs, but may actually hold 110. The best place in which to work an incubator is a dry, airy cellar, or, failing that, a room, or shed, where there

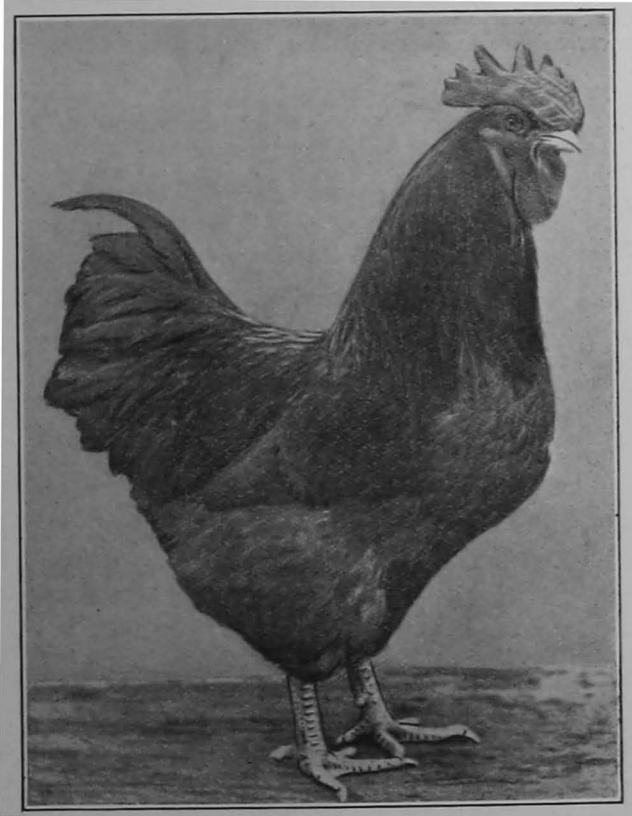

FIG. 301.—Buff Orpington Cockerel.

is no chance of sudden noises injuring the eggs or disturbing the chicks, and in which a fairly even temperature can be easily maintained.

*Brooders.*—It will also be advisable to have one or two brooders or foster-mothers, both hot and cold.

*Breeds of Poultry.*—The student need only concern himself with those pure breeds of poultry or cross-bred fowls which appear to be best suited for his purpose, or his farm. Tastes vary, and fashion



changes from time to time ; and we know from laying competitions that the productiveness of any particular breed is not particularly fixed or inherent in that breed. On the other hand, it appears that certain non-sitting breeds are equally capable of laying as many eggs in winter as some recognized laying strains, provided that sufficient care is taken in selecting them. The production of eggs cannot be recorded in the same way as the daily yield of milk from dairy cows ; hence a plan of trapping the hen had to be devised, in order that she might be credited with the number of eggs she laid during the year, and in order to distinguish her a ring with a stamped number is made to encircle one leg. A selection can in this manner be made,

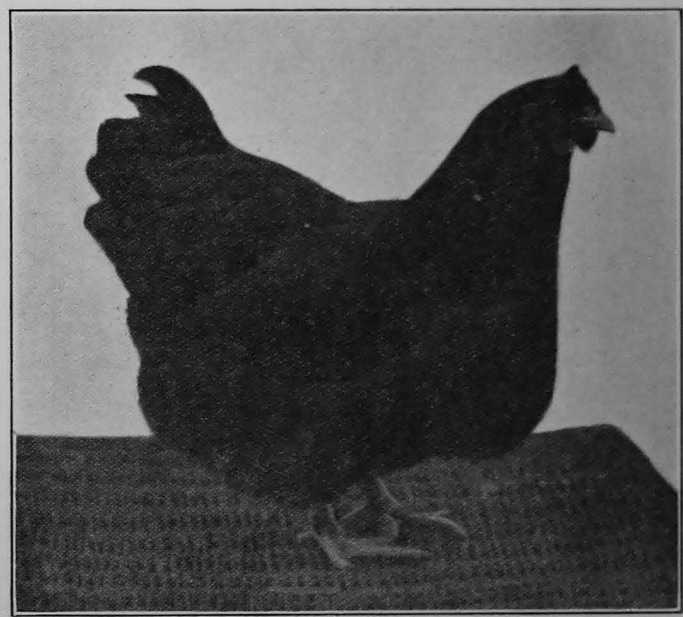

FIG. 302.—Buff Orpington Pullet.

from which breeding may proceed with the definite object of securing the largest number of eggs from a given number of fowls. As in the choice of a bull in the breeding of dairy cattle, so must the male bird represent an equally fertile ancestry as with the female.

**Selecting Stock Birds.**—In selecting fowls for stock purposes, there are three important considerations to be kept in view. These are (1) soil, (2) situation, and (3) market. Further, the question as to whether it is the intention to produce eggs or table fowls must be considered. Whichever branch is decided upon, the advice may be confidently given that it is much better to start on a small scale, than undertake a large business at the commencement. Subsequently, if it is found that the department pays it may be extended.

*Layers.*—If it is decided to take up egg-production and keep pure-bred birds, the best plan is to select some non-sitters and some general purpose fowls. For the former, Leghorns (Figs. 297 and 298), Minorcas, Anconas, or Campines may be chosen, and for the latter, Orpingtons (Figs. 299, 300, 301, and 302), Wyandottes, Rocks, Sussex (Fig. 303), Croad Langshans, or Faverolles. It should be borne in mind that there is no *best* breed for laying. The question is entirely a matter of strain.

If pure-bred fowls are not required, the following will be found good laying crosses: Leghorn-Orpington, Leghorn-Faverolles, and Minorca-Croad-Langshan, the male parent being the first-named in each cross. These crosses produce layers of good-sized, tinted eggs,

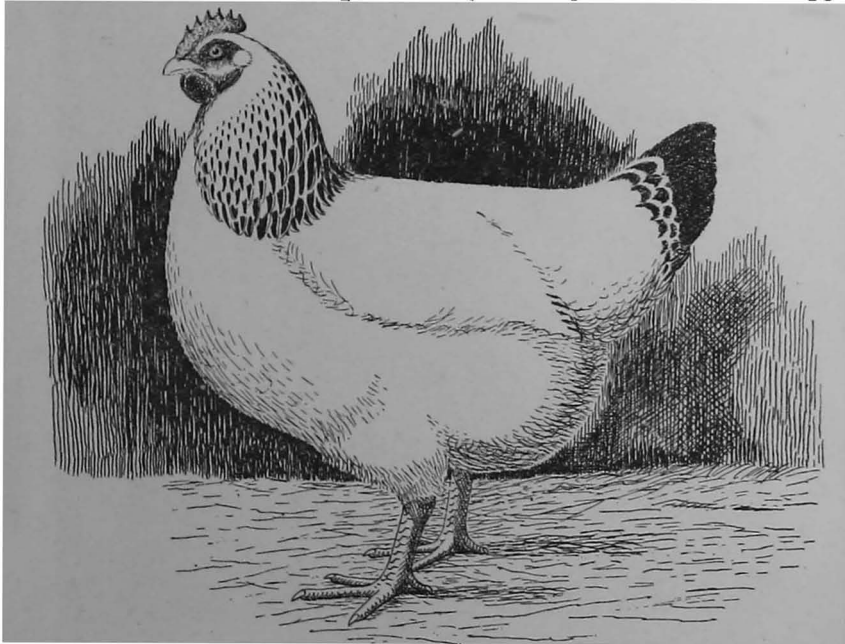

FIG. 303.—Light Sussex Hen.

and will succeed on cold soils and situations, better than pure non-sitting breeds. There is also the additional advantage that there is not so much trouble with broody birds as with pure-bred, general purpose fowls.

*Table Fowls.*—If it is intended to produce table poultry, the best result will be obtained by crossing either Orpingtons, Sussex, Faverolles, Wyandottes, or Rocks, with Indian Game (Fig. 305). Any of these crosses will produce strong, quick-growing chickens which will carry a nice amount of flesh and fatten quickly.

With regard to the age of stock birds, cockerels should never be mated with pullets, the best results being secured by allying a well-developed early-hatched cockerel with hens of two, or three years old.

A cockerel of a non-sitting breed can be mated to eight or twelve hens, and an Indian Game cockerel to six or nine hens, according to the time of year. With a two-year-old cock, it would be advisable to mate with a smaller number of pullets.

Ordinary farm-yard fowls can often be improved at small expense by purchasing pure-bred cockerels, and mating them with hens selected for the special purpose in view. If intended to produce table fowls, hens should be chosen which are large and wide, with long, straight breastbones. For producing layers, medium-sized hens of bright and active habits should be chosen. When purchasing birds for stock purposes, great care should be always exercised to see that they are perfectly healthy. There should be no spots in the mouth



FIG. 304.—Old English Game Cock.

or throat, nor any frothiness round the eyes, nor discharge from the nostrils, nor rough scales on the shanks. New purchases should always be kept apart from the rest of the stock for at least ten days in case any disease may show itself.

Points of an Exhibition Fowl.—In order to distinguish one breed from another, the student cannot do better than attend some of the important poultry shows. The exhibition poultry, staged at these shows, possess characteristics which will greatly assist him to make this distinction. In some breeds many of these points have been developed because they were found originally in characteristic specimens of the breed, as for instance in Dorkings and Game fowls.

As an example, the following are the chief points of a good specimen of a Dorking cock (Fig. 306) :—

Head.—Large and broad.

Comb.—Moderately large and upright.

Neck.—Rather short, broad, and curved.

Body.—Deep and massive, large long rectangular shape, when viewed sideways.

Breast.—Broad and well rounded, with long straight breastbone.

Back.—Broad and long.

Tail.—Full and carried well out.

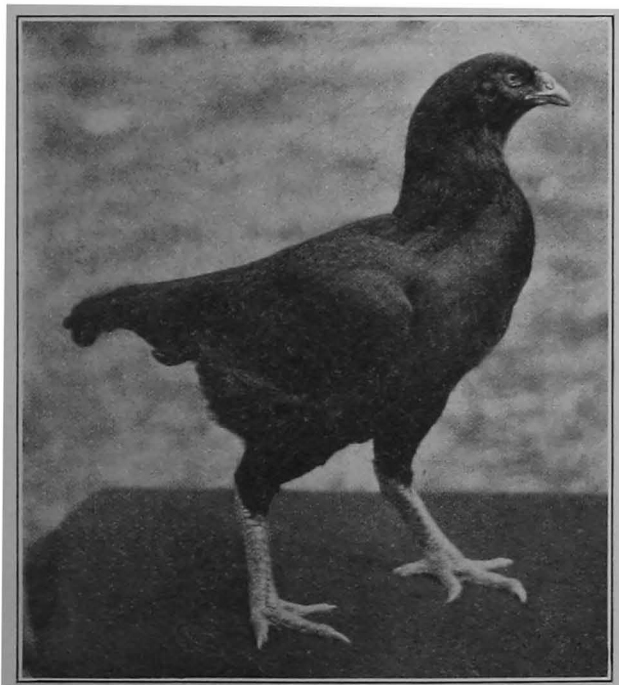

FIG. 305.—Indian Game Hen.

Legs.—White, stout, and strong, set well apart.

Toes.—Five on each foot, well spread and straight, fifth toes separate from fourth, and directed upwards.

Incubation.—There are two methods of incubation—natural and artificial. The former is to be recommended where only a small number of chickens are hatched. In selecting eggs for incubation choose new-laid ones, of moderate size, and good shape; very round, or pointed eggs should be discarded, and also thin or rough-shelled ones. In storing for incubation, a temperature is needed of from 50° to 60° F., and the eggs should be laid on their sides in bran, sawdust, or

some other soft material, and covered with a cloth to prevent undue evaporation. They must be turned every day; otherwise the yolks may adhere to the shells; and eggs that have travelled some distance should be allowed to rest on their sides for eighteen to twenty-four hours before placing them in the incubator. The time taken to hatch the different kinds of eggs is as follows:—hen, 21; duck, 28; turkey, 26 to 29; goose, 28 to 30; guinea-fowl, 25 to 26 days. A section through a hen's egg is shown in Fig. 308.

*Natural Incubation.*—The nest-box, which must be well ventilated over the top, should be placed in a quiet shed preferably with an

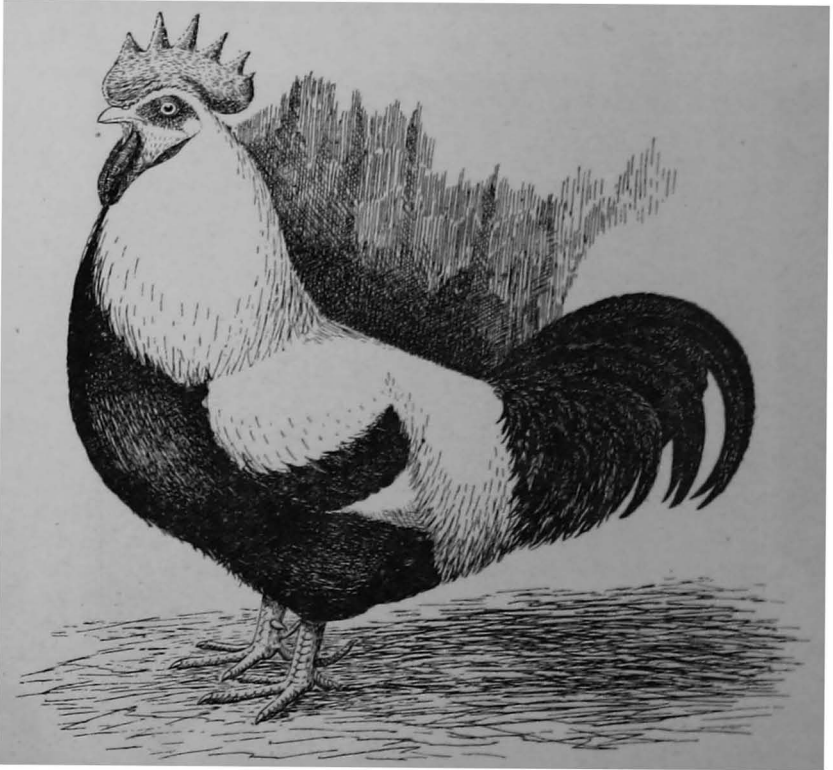

FIG. 306.—Silver-grey Dorking Cock.

earth floor in cold weather, and out of doors in a sheltered position in mild weather. The box should have fine-meshed wire netting underneath to prevent rats from disturbing the hen or robbing the nest, and should be placed on the bare earth. A sod of turf or 3 inches of soil should be put in and pressed well down, with the centre slightly lower than the sides; and some hay or straw must be placed on the top to form a nest, filling all the corners very carefully so that the eggs cannot roll from under the hen and become chilled.

The signs of a hen becoming broody are, persistently remaining on the nest without laying, and when disturbed walking about clucking and with feathers ruffled. On noticing these signs place the hen on the nest at night on a few china eggs. If she appears to be sitting quietly and is anxious to get back to the nest when fed the next day the eggs she is to incubate should be placed under her the following night. A wire-covered run should be placed in front of the sitting-box, into which the hen is put to feed. Or, instead of this run, a wooden peg may be driven into the ground near to the sitting-box, one end of a piece of string about a yard long tied to it, and the other end of the string secured to the hen's leg, when she is taken off to feed.

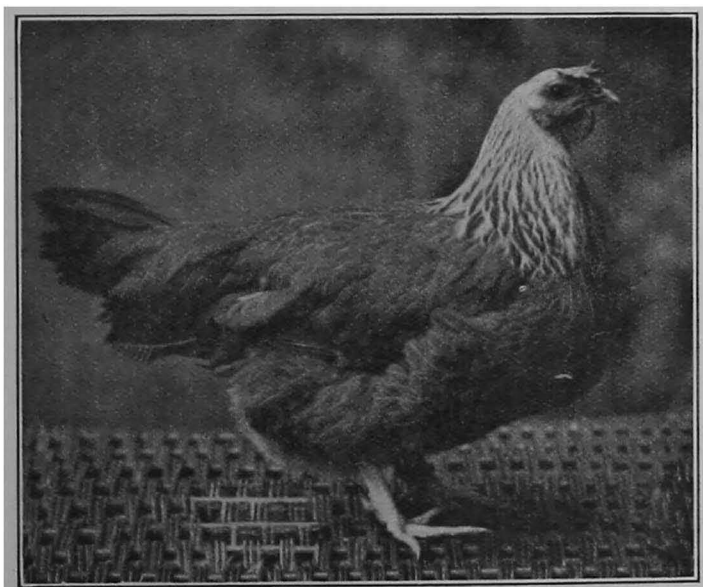

FIG. 307.—Silver-grey Dorking Hen.

The hen should be carefully lifted off the eggs each day at the same time for ten to twenty minutes, or even half an hour in warm weather, to feed and drink. If she breaks an egg and the others become soiled wash them at once in some warm water. The best food for the sitting hen is maize or plump barley, fresh water, grit and oyster shell, and some dry soil must always be provided in which she can have a dust bath to rid herself of vermin. In place of this latter, however, the hen can be dusted thoroughly with flowers of sulphur or some good insect powder, two or three times during the sitting period.

The eggs may be tested for fertility at about the end of the seventh day after setting them. An egg-tester, or a piece of stout cardboard about 6 or 8 inches square is required for this purpose, and in the centre of this a hole should be cut slightly smaller than the size of

The signs of a hen becoming broody are, persistently remaining on the nest without laying, and when disturbed walking about clucking and with feathers ruffled. On noticing these signs place the hen on the nest at night on a few china eggs. If she appears to be sitting quietly and is anxious to get back to the nest when fed the next day the eggs she is to incubate should be placed under her the following night. A wire-covered run should be placed in front of the sitting-box, into which the hen is put to feed. Or, instead of this run, a wooden peg may be driven into the ground near to the sitting-box, one end of a piece of string about a yard long tied to it, and the other end of the string secured to the hen's leg, when she is taken off to feed.

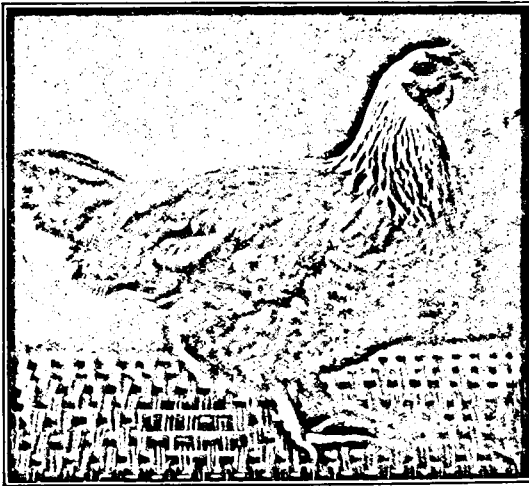

FIG. 307.—Silver-grey Dorking Hen.

The hen should be carefully lifted off the eggs each day at the same time for ten to twenty minutes, or even half an hour in warm weather, to feed and drink. If she breaks an egg and the others become soiled wash them at once in some warm water. The best food for the sitting hen is maize or plump barley, fresh water, grit and oyster shell, and some dry soil must always be provided in which she can have a dust bath to rid herself of vermin. In place of this latter, however, the hen can be dusted thoroughly with flowers of sulphur or some good insect powder, two or three times during the sitting period.

The eggs may be tested for fertility at about the end of the seventh day after setting them. An egg-tester, or a piece of stout cardboard about 6 or 8 inches square is required for this purpose, and in the centre of this a hole should be cut slightly smaller than the size of

an egg. Hold the egg over the hole on the side nearest the eye, before a bright light, and turn it slowly from one side to another. In a fertile egg a dark spot will be seen with lines radiating from it; if, however, the egg is perfectly clear like a new-laid one, it is infertile, and should at once be removed from the nest.

When the eggs commence to hatch the hen should not be moved from the nest until all the chickens are out, but it is advisable to pass the hand carefully under her two or three times during the day and to remove any empty shells. If at this period she appears restless the chickens should be taken from under her as soon as dry, and placed in a basket lined with soft hay, covered with a piece of flannel, and put in a warm place until all are hatched. The hen must be given a good feed and some water to drink, and she should then be placed in a clean coop with a removable floor, and the chickens placed under her. In wet weather the floor should be used and covered with either dry soil, peat moss, or chaff. In fine weather the floor should be removed and only replaced for the night as a protection from rats. When the chickens are about twenty-four hours old they must be given their first feed.

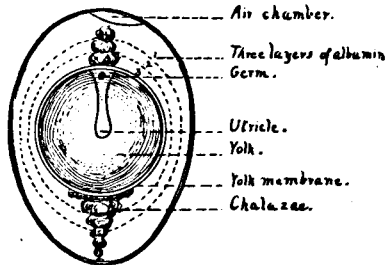

FIG. 308.—Section through a Hen's Egg.

*Artificial Incubation.*—There are two kinds of incubating machines now on the market—hot-water and hot-air incubators. The former (Fig. 309) have the advantage that should the lamp go out the water will remain hot for some time, thus lessening the danger of the eggs becoming chilled. It is always advisable to purchase incubators direct from the manufacturer, particular care being necessary if you are tempted to invest in a second-hand machine. Whatever style of incubator is chosen the directions for working as supplied by the makers should be followed to the letter; probably the reason why so many people are disappointed with these machines is because they neglect this. The makers know best, however, what their machines are capable of doing, and how they ought to be worked.

The best place in which to work an incubator is a dry airy cellar, free from draughts, sudden noises, and vibration of any kind. Unless the incubator stands on legs of its own, it should be placed firmly on a strong bench or table at a convenient height from the ground,



care being taken to see that it stands perfectly level. Having carefully fitted up the machine and filled the tank—if it has one—the lamp should be filled, the wick trimmed and lighted, and adjustments made according to the directions received with the machine. When the incubator has maintained an even temperature for two or three days the eggs may be put in the drawer. To obtain the best results, the eggs should not be more than a week old; in fact, the fresher they are the better.

All the eggs should be marked with the date on which they were set, and also with a X on the opposite side. The drawer should be completely filled at the commencement; this is preferable to adding eggs later, as this is very liable to chill those already there. If fresh eggs are to be introduced, it is advisable to warm them in the drying-box for several hours previously. The machine should then be left entirely alone for the first twenty-four hours, so as to give the eggs every chance to warm up. Afterwards, they should be turned twice a day, morning and evening, a half-turn being given each time.

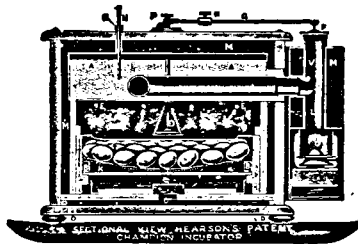

FIG. 309.—Sectional view of Hearson's Patent Champion Incubator.

The eggs must be aired at least once a day, preferably in the morning, the time of exposure being from ten to thirty minutes, according to the temperature of the room. In doing this the drawer should always be taken out and placed on a table or bench so that there shall be no draughts on the eggs through the bottom of the drawer. On about the seventh day, the eggs may be tested in the manner described in the paragraph on natural incubation, and again on about the twelfth to the fourteenth day, in order to remove any that may have become addled. The appearance of the embryo chick at various stages of incubation is shown in Figs. 310-313.

The eggs should not be turned after the nineteenth day, as this will give the chickens every chance to chip the shell on the top side. If they chip it on the under side there is a chance of their being suffocated. It is not advisable to open the drawer for the purpose of examining the condition of the eggs at this stage oftener than, say, once every six hours; egg-shells may then be removed, and the chickens placed in the drying-box. A record of the temperature of the drawer and room should be kept throughout this period, observations being taken twice or thrice a day; in this way one can

often arrive at the cause of an unsuccessful hatch. Of course, the machine should always be thoroughly cleaned, not forgetting the flues, after each hatch. The canvases ought to be scalded with boiling water at least once during the period of incubation, and the perforated egg-frame should also be thoroughly cleansed.

**Soil Conditions.**—Eggs vary in quality according to the soil upon which they are produced. The method of feeding also has some effect.

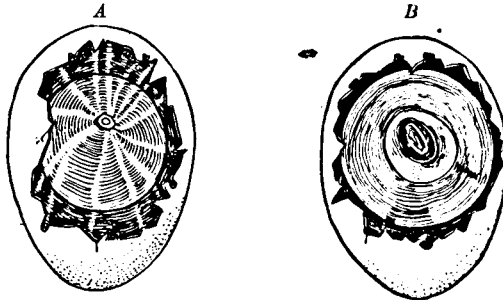

FIG. 310.—*A*, new-laid egg with part of shell removed; *B*, egg after thirty-six hours in incubator, embryo chick magnified.

Chickens, like plants, are usually backward in growth when they are reared on soils exposed to cold winds, which are often moist, and consequently of a very low temperature. Turkeys, for example, are very difficult to rear successfully, except on soils of a light, warm, and dry character, well sheltered from cold winds.

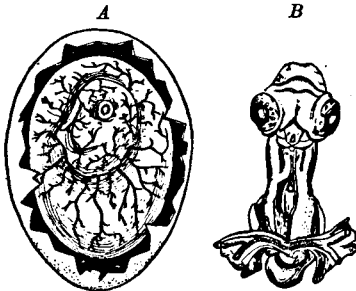

FIG. 311.—*A*, seven days after incubation; *B*, embryo chick magnified.

**Principles of Feeding.**—The feeding of poultry necessitates very great care. When proper attention is given, eggs can be freely produced in seasons when they are usually scarce. Especially must economy be exercised in the use of meals and grains. On the majority of farms these foods are fairly plentiful and there is a tendency to use them too lavishly. This entails both waste and disappointment,

for it is just as injurious to overfeed as to underfeed. Compound, heating, foods must be given in cold weather, while an adequate supply of albuminoids or flesh-formers is essential in the case of young growing birds. The food of adult fowls, on the other hand, has merely to replace worn-out tissues, and to restore energy. Hens which are about to lay must have their concentrated diet gradually increased, but not with an excess of carbo-hydrates or starchy and

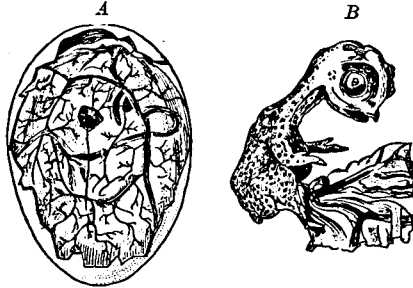

FIG. 312.—*A*, ten days after incubation; *B*, embryo chick with the vesicle removed.

fatty foods (non-nitrogenous foods); otherwise the intestinal canal will be heavily stored with fat, and this will interfere with egg-production. As in the case of any animal which has to nourish a foetus, laying hens have a strain put on them far beyond their own bodily requirements.

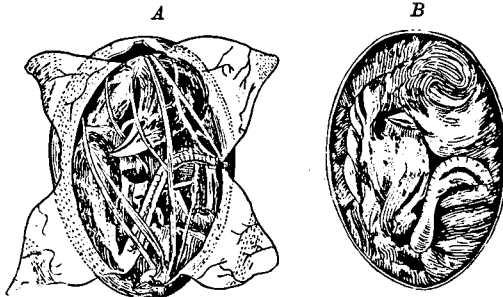

FIG. 313.—*A*, eighteen days after incubation, with vesicle removed to show embryo chick; *B*, twenty days after incubation, showing position of chick.

The first meal of the day should consist of mixed meals, sufficiently saturated with water, or separated milk, to form a moist crumbly mass. When fowls are allowed plenty of freedom, and space over which to forage, the dietary must be modified accordingly, and the ordinary feeding of green foods such as cabbage, mangels, and other roots at mid-day, may be dispensed with at once. On cold winter

mornings the food should always be given in a warm state if possible, while the supply of maize, barley, or other warming foods, should be increased, or extra quantities of them substituted for others having less heat-producing properties. An hour or so before dusk, the birds should be given just that amount of tailing corn which they can conveniently clear up. Sharp grit, oyster shell, and a constant supply of wholesome water must always be within their reach.

**Chicken Rearing.**—Chicken may be hatched either by artificial or natural means. In the former case, brooders or foster-mothers, as they are called, are employed. These are small houses of which there are many different makes and styles on the market. Most of them are about 6 or 7 feet long and about 3 feet wide; and are divided into two compartments, one heated for sleeping, and the other cool for feeding, and for the exercise of the chicks. In some makes, a water-tank is placed in the roof of the sleeping compartment, and pipes passing through the tank or flues, conveying hot air from a lamp. Others have a hot-air tank or chamber with flues passing through, and there is another type that has the heat thrown on to the chickens by means of a metal disc or radiator.

**Brooders.**—In all the different makes of brooders, the principle is much the same, inasmuch as the lamp only radiates heat on to the chickens from above. The brooder which allows the heat to come directly from the lamp into the chamber containing the chickens is not to be recommended, and should never be used on any occasion. The fumes from the lamp are not only poisonous, but there is the great risk of the lamp smoking and killing the chickens. In hot-water brooders there is one advantage, inasmuch as if the lamp goes out the water retains its heat for some time, and thus lessens the risk of the chickens becoming chilled. Something may also be said in favour of hot-air brooders; when the chickens are old enough, and the weather is mild, the lamp can be extinguished during the warm part of the day, and when it is lighted again the house very quickly warms up to the required temperature.

The temperature of the sleeping compartment should be 90° F. for the first two days, afterwards falling to 85°. A week later it should be reduced to 80°, and the chickens are hardened off by still further lowering the temperature until by the time they are from five to eight weeks old—according to the state of the weather and the season of the year—they can do without the lamp altogether.

The chief point in connexion with a brooder is, in the first place, to have a good one. Then a well-sheltered spot should always be selected in which to work it early in the year, and the best results will usually be obtained when it is placed under an open-fronted shed. Moreover, it must be moved regularly on to fresh ground every day; the lamp must be trimmed and filled daily, and the floor material changed several times a week. There is a "fireless" brooder now on the market. This keeps the chickens warm by means of an arrangement of soft material suspended from the roof of the sleeping compartment and adjusted so that it just touches their backs; on it is placed a quilt of down or feathers. In any type of brooder, as soon as the chickens have been moved out, the machine should

be thoroughly cleaned and disinfected before the next lot are put in.

**Wet Feeding.**—Chickens may be fed on either the “wet” or the “dry” system. The former method consists in feeding the chicks about thirty-six hours after they are hatched with finely chopped, hard-boiled egg and bread crumbs, moistened with milk. For the first three days the food is given at intervals of two hours throughout the day, when biscuit meal is gradually substituted for chopped egg; and at a later stage, sharps, Sussex ground oats, coarse oatmeal, or barley may take the place of the biscuit meal, and granulated meat in small proportions can be added with advantage. Coarse oatmeal porridge, or boiled rice, may be occasionally substituted, when dried a little by the admixture of biscuit meal. After continuing with this dietary for three weeks or so, the chicks may be fed at intervals of four hours, the last meal of the day consisting of cracked wheat, barley, and maize, with millet, dani, canary seed, or a similar mixture of seeds. At six weeks old, four feeds a day will suffice, and these should comprise a mash in the morning, mixed grain at, say, 10 a.m., a mash at 2 p.m., with grain again before roosting time. When three months old, soft food in the morning, followed by two meals of grain at intervals throughout the day, will be all that is required, provided that attention is given to green food when the birds are confined in pens.

**Dry Feeding.**—In the dry feeding system, mixed broken grains and seeds, together with desiccated insects, are given for the first month by scattering the mixture among the loose litter, so simultaneously affording a natural form of exercise. At four weeks old, a mash is given each morning, and sometimes the more nitrogenous meat meals may be introduced. The latter stages of feeding differ very little from what has been already outlined, dry feeding being closely associated with the earlier stages of the bird's life. Dry feeding is more expensive than wet feeding, but it is, as a rule, productive of better results owing to the fact that it provides abundance of exercise, while there is less risk of diarrhoea, which is often prevalent among young chickens indiscriminately fed on sloppy foods, and given an excess of vegetable matter during the cold days of winter.

**Preparing for Table.**—Age is the chief consideration in choosing poultry for the table. Young fowls have a fresh facial appearance, the eyelids are free from lines and wrinkles, and there are long silky hairs under the wings, and pink-coloured veins. When a bird is twelve months old these indications begin to disappear, and the skin assumes an even white colour. Older birds have a dry, shrivelled-up appearance about the face, and the skin of the claws is hard, and has a metallic lustre; while the scales are coarse and horny as compared with the smooth and supple skin of younger birds. Moreover, if the bones of the pelvis of young birds are examined, they will be found to be almost touching in a fowl that has not yet commenced laying; but in an older bird which has been laying for some time, they will be much wider apart. Age, size, weight, quality, and quantity of breast meat; straightness of keel; fineness of bone; good

colour of skin, and absence of offal and surplus fat, are all important points in choosing a fowl for the table.

*Killing and Plucking.*—The most effective method of killing a fowl is that of dislocating its neck. Grasp the two legs and the tip of each wing in the left hand, with the back of the hand turned upwards; take hold of the head with the right hand so that the middle finger is under the bill, thus making the comb occupy the middle of the hand. The left hand, with its contents, is now held firmly against the operator's left hip, the right hand, grasping the head of the bird as directed, being held firmly against the right leg near the knee. By a sharp extension of the neck, at the same time bending the head suddenly backwards, the organ will be completely dislocated at one stroke, and the intervening cavity will quickly fill with blood which will soon congeal.

The operation of plucking cannot be performed too soon after the bird is killed, for when the flesh has had time to lose its natural heat,

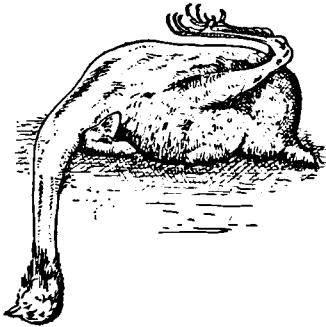

FIG. 314.—Fowl prepared for Market.

greater difficulty is experienced in detaching the feathers, and consequently there is more danger of tearing the flesh. After plucking, singe the bird, to remove the hair-like feathers, and remove the stubs with a short blunt knife. The hocks should be merely tied together, and then, while the birds are still warm, they should be placed breast downwards in a shaping-board to cool. A shaping-board consists merely of two pieces of wood nailed together in the shape of a trough with a triangular bottom, and laid on its side. Pressure is applied by placing a piece of board on the back of the bird, and a weight or a few bricks on it. A brick should be placed on each side of the bird. A fowl prepared for market is shown in Fig. 314.

*Trussing for Roasting* (Fig. 315).—The dresser, when preparing poultry for roasting purposes, takes the plucked bird and makes a sharp incision inside each leg just below the hock, on the scaly part of the leg. This exposes the sinews, which can be easily removed by inserting a wooden skewer under them and using it as a lever. When removed in this manner they can be cut off at the point where

they protrude from the shank, and the toes may then be removed. The next operation consists in turning the bird on its breast, cutting the skin at the back of the neck close to the shoulders, and severing the neck where it joins the body, being careful at the same time not to cut the skin on the lower or breast side of the fowl. Next turn the severed end of the neck away from the body, and cut through the skin on the breast side, at a point about 4 inches from the body, thus converting the skin of the front of the neck into a flap. The crop can then be easily removed.

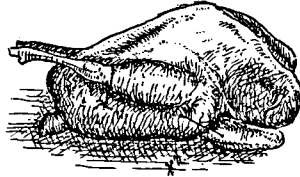

FIG. 315.—Fowl Trussed for Roasting.

The removal of the merrythought is merely a matter of choice, but it is well to remember that if this is done greater ease in carving the breast is secured, and larger slices of meat can be obtained. The insertion of the trussing knife between the bones and the flesh, enables the merrythought to be withdrawn, without even the smallest quantity of meat being attached to it.

Next, the internal parts of the bird are loosened by inserting the finger in the opening at the base of the neck, and passing it round the whole of the organs. Should the bird be excessively fat, the lining of the interior can be easily loosened by rolling the body on the table

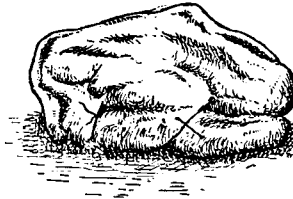

FIG. 316.—Fowl Trussed for Boiling.

under the hand. The fowl should now be placed on the table, with the tail uppermost, and a sharp incision made between the tail and the vent. Through this opening the finger of the trusser is inserted, and a loop of the bowel pulled out. The knife being placed under the loop, cuts the vent without the slightest difficulty, and leaves a sufficiently large opening for the hand to be inserted so as to seize the gizzard. If the loosening process has been carefully carried out, the whole of the intestines, the heart, and the lungs, can be removed in one whole mass.

This operation is both clean and expeditious, and the trussing may now be completed by taking a needle about 8 inches long, threaded with thin, strong string. The legs should now be placed at right angles to the carcass, pressed down, and the needle passed through one of them, appearing on the other side of the body at a similar place in the other leg. The bird must then be turned over, and the needle threaded through the second joint and pinion of each wing, when it will appear close to where it was first put into the fowl. The two ends of the string are then securely tied. The latter operation may be done more conveniently by suspending the fowl in the air after the first tie has been made, so that the weight will prevent the knot from slipping.

To keep the legs in position, pass the needle, with the string still attached, through the "oyster" close to the backbone, over the legs, and back through the body, and under the end of the breastbone. The ends of the string can now be securely tied, and the operation is complete.

*Trussing for Boiling* (Fig. 316).—To truss a fowl for boiling the internal organs should be removed in a similar manner as advised in the previous paragraph on the preparation for roasting. The tips of the wings, together with the thumb pinion, should then be cut away, and also the loose strip of skin left after the removal of the quill feathers. The fowl having been drawn, a cross cut should be made at the back of the legs 1 inch above the hock, and another in front of about  $1\frac{1}{2}$  inches below the joint. This will enable the feet to be brought right round into position at the back of the fowl. The skin of each side of the breast is then loosened by passing the fingers underneath, and, by grasping the shanks, the legs can be pushed up under the skin. The fowl is next turned over and the shoulders cracked by striking them sharply between the wings and the spine with a trussing knife. This will enable the wings to be brought closer to the body, after which the trussing is complete.

The trussing needle threaded with strong string is now passed through the leg just near the hock, appearing on the other side at the corresponding part of the other leg; then through the pinion and joint of each wing, and the two ends are securely tied. The position of the hocks which are hidden under the skin should next be ascertained, and in order to secure the ends of the legs, the needle, still threaded with thin string, is passed through the body just above the hock, under the breastbone, and through the leg on the other side of the body, thoroughly tightened and tied securely.



## CHAPTER II.

### TURKEYS, GEESE, GUINEA-FOWLS, AND RABBITS.

THE principal breeds of turkeys in this country are the Bronze, the Black, the Cambridge, and the White. Of recent years, the American Mammoth Bronze (Fig. 317) has become very popular owing chiefly to its size and hardiness of constitution, for it certainly cannot be regarded as the finest in quality of flesh. Fully-matured birds of this type have been known to weigh 50 lb.

White turkeys are supposed to be more delicate than others, but as a matter of fact there are many poultry-keepers who maintain that they are as hardy as others. The black-plumaged birds, of which there are two leading kinds, namely the Norfolk and the French, are of average size, the males rarely exceeding 22 lb., and the females 14 lb. in weight.

*Soil and Situation.*—The breeding and rearing of turkeys is a branch of poultry-keeping that needs to be approached with a considerable amount of caution. If it is attempted, for example, on restricted areas, or on cold damp soils, the results will invariably prove disastrous. The land for rearing turkeys must be sweet and quite free from other poultry. The birds can stand a dry cold air, but a continuous damp atmosphere soon kills them off. Perhaps the most favourable conditions are found where the ground is undulating and the soil warm, and especially if a belt or plantation of open-branched trees is available for the birds to roost upon without fear of disturbance from foxes, as housing accommodation often proves a serious drawback unless a large open shed is available. The reason why turkeys like a good run is because they thrive on all kinds of insect life which is abundant in the soil, and the supply of these insects naturally becomes exhausted when the birds are confined to restricted areas.

*Selecting Stock Birds.*—It is not until the third year that a turkey comes to maturity; hence stock birds that are older than this are to be preferred for breeding purposes, since there will then be less risk of their offspring inheriting a weakened constitution. If the hens are older, a first season cock may be used, but all cocks and hens more than five years old should be got rid of without delay. Hens may, however, be allowed to breed for a number of years, one hen being allowed for every eight or ten birds to be reared.

As a rule, turkeys prefer to select their own nests when laying, and in order to assist them a few boxes or barrels should be placed in secluded spots. The hens must not be allowed to sit until they have laid two batches of eggs. Eleven to fifteen eggs will be sufficient

for one sitting, and during the twenty-eight days of incubation, the hen must be supplied with food and water, and never disturbed. Where an incubator is available it is a good plan to place the eggs in it two or three days before they hatch out, as turkeys are liable to crush their chicks just as they are hatching, and before they can move about briskly on their legs. The chicks should be returned to the mother bird when they are ready for the coops. Some breeders consider it is better to hatch and rear under ordinary hens, giving from nine to a dozen eggs to each, according to the size of the eggs and the hens.



FIG. 317.—American Mammoth Bronze Turkey Cockerel.

Young turkeys must always be well protected from the wet until they have "shot the red" at about ten weeks old. After that age, as a rule, they give very little trouble, except that they require to be fed sparingly, and often.

*Feeding.*—Turkeys are meat-eaters by nature, and if this class of food is not sufficiently plentiful, fresh meat scraps must be supplied, together with the more nutritious kinds of grains and meal, and boiled rice. Green food sometimes causes diarrhœa when given carelessly; but a little of it is essential, and need not do any harm. In each feed of soft-stuff for turkeys, plenty of chopped onion or dandelion should

be included, and a supply of good sharp flint should also be ready at hand, together with plenty of pure fresh water.

When the young birds are from ten to twelve weeks old some of the above delicacies may be omitted for less expensive and yet equally nourishing forms of food, as turkeys must not be given foods that are too rich in fat. As the time for their preparation for the Christmas market draws near, separated milk enters largely into their dietary, being mixed with the more nutritious meals, which are so essential for the production of a good quality of flesh. The period of fattening should not be longer than three weeks, as the birds are impatient of confinement; and if kept longer they go back in condition, even if confined in open sheds.

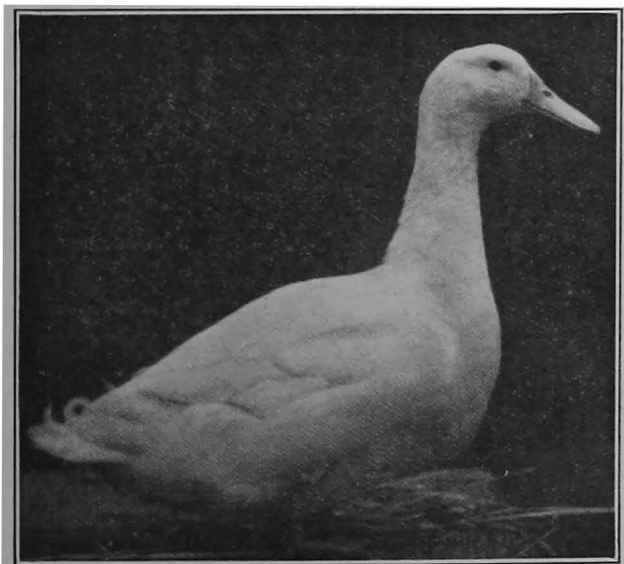

FIG. 318.—Aylesbury Drake.

**Ducks.**—Duck-breeding pens should be made up before the new year, a full pen usually consisting of ten ducks and three drakes. This should secure abundance of fertile eggs for hatching from March to May if desirable. All stock ducks, with the exception of Indian Runners, require water to swim in to ensure fertile eggs.

As with fowls, all mashes should be given warm in cold weather and should contain maize or barley-meal. Grain is of little service to ducks, unless well soaked and partially cooked; and green food, water, and grit should be freely supplied. With but few exceptions young ducks may be fed with moist food much after the same manner as fowls, except that a mash must be substituted for hard grain, while care must be taken to keep the ducklings sheltered from hot sunshine, heavy rains, or cold piercing winds until they are sufficiently strong.

The beginner has often been amazed at finding a batch of ducklings stiff and lifeless, due to their downy coats having been drenched, and their bodies chilled by exposure to heavy rains.

If table ducks are to be reared profitably, they should be kept penned up practically from the day they are hatched, and, as with porkers and other animals fed for the butcher at an early age, fattening must proceed gradually from birth and never be given a check through neglect of feeding, or the want of such comforts as conduce to development and the laying on of flesh. Although mixed meals, moistened with separated milk, are excellent for fattening, boiled rice is still better, provided it is carefully cooked over a slow fire, allowing one part of rice to three parts of water, which it will gradually absorb.

Ducks, like pigs, are often regarded as gluttonous, and must therefore be carefully fed, and on no account allowed stale food, and should clear up all the food in the trough at a meal ; otherwise,



FIG. 319.—Pekin Ducks.

as with other animals, a very detrimental effect will be exerted upon the appetite, and interfere with those peaceful rests between meals so essential for the production of flesh and weight.

The fattening period proper usually commences when ducklings are about five weeks old, and extends to the eighth week, by which time a weight of from 5 to 6 lb. is attained ; adult Aylesbury drakes will sometimes weigh as much as 9 or 10 lb. and ducks 8 or 9 lb. at this age.

*Breeds.*—All domesticated ducks are supposed to be descended from the Mallard or wild duck, commonly met with throughout Europe, Asia, and North America. Although there are some ten or so distinct varieties of domesticated ducks, only four of these, at the most, need concern the farmer, namely, the Aylesbury, Pekin, Rouen, and Indian Runner.

*The Aylesbury* (Fig. 318), or Large White Duck, is famous on account of its rapidity of growth, being especially well adapted for

early marketing, and ready quite a fortnight in advance of any other breed. The flesh is white, but not so good in quality as that of many less familiar breeds, as for example the Cayuga and the Huttegen, both of which are mostly preferred for private use. The plumage of the Aylesbury is pure white, the bill flesh-coloured, and the legs a bright orange. The body is boat-shaped, the keel or breastbone being almost parallel with the ground, thus indicating a capacity for carrying a large amount of breast meat, an important feature in all classes of table poultry. It is a fairly prolific layer, often producing 150 eggs in the course of a year.

*The Pekin* (Fig. 319) cannot be got ready for the market until quite a fortnight after the Aylesbury. It is a better layer than the Aylesbury, but some prejudice attaches to it in this country on account of its yellow flesh, which by the way is appreciated by the Americans for some unaccountable reason, probably much in the same way as the rich golden or yellow carcasses of Guernsey or Jersey bullocks are rejected by ourselves, yet appreciated by the inhabitants of the islands from which these breeds originated.

The plumage of the Pekin is of a yellowish-white colour, and easily distinguishable from the Aylesbury, which is pure white, also the bill of the former is bright-yellow and the eye slate-blue, and whereas the Aylesbury is boat-shaped the body of the Pekin is very erect, long, and wide, the legs being placed further back. Although the Pekin is slower in growth it ultimately attains a weight equal to that of the Aylesbury.

*The Rouen* is the largest of domesticated ducks, the drakes often scaling up to 12 lb. The ducklings are very hardy and easy to rear, but develop slowly, and are therefore best suited for the autumn and winter markets. Rouens are excellent layers, usually commencing to lay about the end of the year, and the eggs are generally fertile. The original colour and shape of the Rouen, both male and female, was that of the wild duck, but breeding and selection have developed a beauty of plumage which must be seen to be appreciated, and also improved the bodily development. The present type has a well-shaped body with a deep keel.

*The Indian Runner* (Fig. 320), as its name implies, is of Indian origin, having first been introduced into Cumberland about seventy years ago. It is principally valued for its laying properties, the eggs being very similar in appearance to ordinary white hens' eggs, a feature in which it excels all other varieties. It is too small to be of value for table purposes, except for home consumption, although its flesh is of excellent texture and rich in quality. Its plumage is fawn and white in colour, the markings being very accurate. The body is small, upright, and of penguin-like carriage, which gives the bird an alert appearance. The legs are of deep-orange colour, and the beak is yellow in young birds, changing in the female to a dark-greenish hue as age develops, and to yellowish-green in the male.

The head of the drake is bronze-green and that of the duck greyish-fawn, marked with streaks of white. The weight of the drake rarely exceeds 5 lb. and that of the duck 4 lb.

**Geese.**—Much might be written upon geese did space permit. At the same time it must be allowed that they no longer occupy the position they at one time filled with regard to Christmas fare. They have been ousted to a great extent by the turkey. The principal breeds of geese are the white Embden and the grey Toulouse (Fig. 321). There are several other varieties such as the Canadian, Danubran, Roman, and Saddleback, but the two first-named are most generally found in this country. Geese largely subsist on grass, and are therefore cheaply maintained, and are most suitable for marshy and low-lying situations where there is plenty of water. They are wonderfully independent, and their large size and courage are a protection from predatory animals—the fox excepted. A set comprises



FIG. 320.—Indian Runner Ducks.

three geese and one gander, and one feature of the race is their longevity, which may have been exaggerated. They should not be used for breeding until they are two years old, and how long they may continue for this purpose it is difficult to say. In any case, and so far as the goose is concerned, there appears to be no defined limits, and cases have been cited of their laying and bringing out goslings for sixty or seventy years. The female begins laying in February, and the period of incubation is twenty-eight days. She generally may be relied upon to lay a second time, and thus a later brood is secured. The usual plan is to employ hens for hatching goose eggs, four eggs being given to one hen. The goslings hatch easily and soon are fit to go about alone. They grow very fast, but continue to follow their foster-mother for some time. At this time they live mostly on grass,

but may be allowed a little maize or other corn. The early broods may be brought out as Michaelmas geese, for which there is always a good demand, and the later and smaller goslings are reserved for Christmas markets. The fattening period is not longer than four or five weeks, and consists in a liberal supply of barley-meal, pollards, and in many cases maize-meal in equal proportions. They may be closely confined in pens, but as they naturally love liberty it is a question whether they will not do equally well if given extra food in their usual haunts. Too much exercise or swimming in ponds is, however, better avoided during fattening.

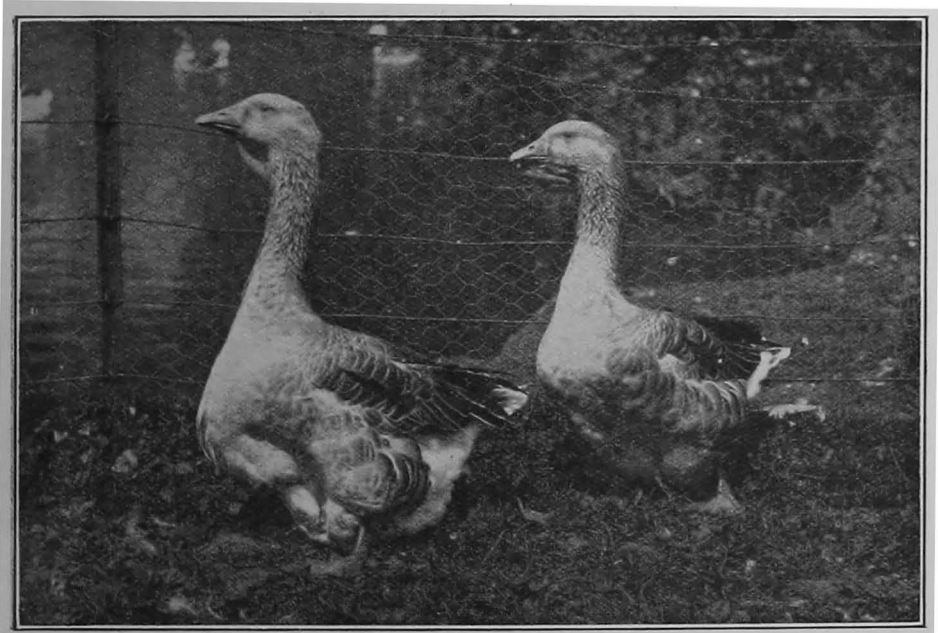

FIG. 321.—Toulouse Geese.

The stubbling of geese after harvest used to be a general method of at least advancing the fattening process, but the rapid breaking up of stubbles by steam- and horse-power has interfered with the old custom of stubbling both geese and pigs. That geese are a profitable stock when kept in suitable situations cannot be doubted, if only because of their simple habits and fare.

**Guinea - fowls.**—These wandering and noisy creatures form a picturesque feature on many farms. They are extremely erratic, and love to perch high on trees, and are disturbing to those who sleep near them. They give the alarm as soon as any strange man or animal approaches, and in this way are a safeguard against thieves. They are uncertain layers, and difficult to catch, especially as they are possessed

but may be allowed a little maize or other corn. The early broods may be brought out as Michaelmas geese, for which there is always a good demand, and the later and smaller goslings are reserved for Christmas markets. The fattening period is not longer than four or five weeks, and consists in a liberal supply of barley-meal, pollards, and in many cases maize-meal in equal proportions. They may be closely confined in pens, but as they naturally love liberty it is a question whether they will not do equally well if given extra food in their usual haunts. Too much exercise or swimming in ponds is, however, better avoided during fattening.

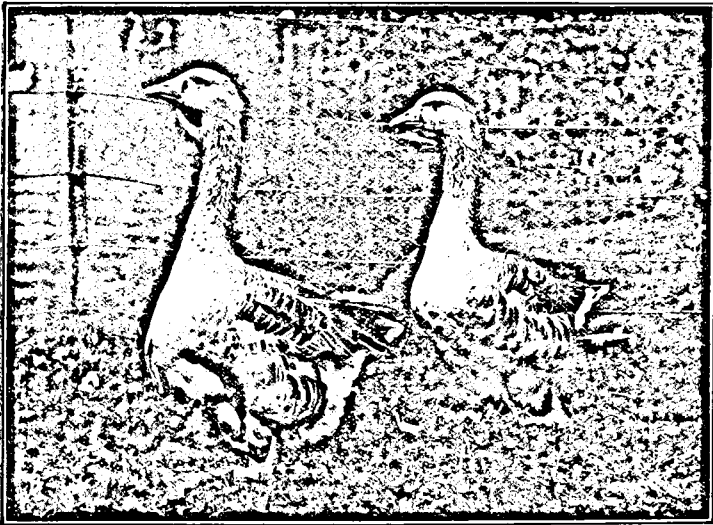

FIG. 321.—Toulouse Geese.

The stubbling of geese after harvest used to be a general method of at least advancing the fattening process, but the rapid breaking up of stubbles by steam- and horse-power has interfered with the old custom of stubbling both geese and pigs. That geese are a profitable stock when kept in suitable situations cannot be doubted, if only because of their simple habits and fare.

Guinea - fowls.—These wandering and noisy creatures form a picturesque feature on many farms. They are extremely erratic, and love to perch high on trees, and are disturbing to those who sleep near them. They give the alarm as soon as any strange man or animal approaches, and in this way are a safeguard against thieves. They are uncertain layers, and difficult to catch, especially as they are possessed



of considerable powers of flight. As to management, they, in most cases, seem to manage their own affairs, and their nests are not easy to find.

Rabbit (*Lepus cuniculus*).—The genus *Lepus* also includes the hare, but the rabbit differs from the hare in size of body and other external features, while its social habits are very different.

The rabbit is extremely prolific, litters of from four to eight in number being produced each year, with as many young on each occasion. Twenty youngsters per annum may, however, be regarded as an average. The doe reproduces at about six months old, and the period of gestation is about thirty days.

*Breeds*.—There are about fifteen recognized breeds of rabbits, that is those possessing some distinctive characteristics; but for all practical purposes the Flemish Giant and the Belgian Hare need only be considered. The Belgian Hare received its name from its likeness to the common English hare as regards weight, shape, and lacing of the ears; while the general appearance of the coat, notwithstanding that the animal has no hare blood in its veins, is to all intents and purposes that of a true hare. The chief disadvantage of the breed is that it lacks hardiness, which is largely accounted for by continuous in-and-in breeding, which, although securing many "points" for exhibition purposes, has weakened the animal's constitution.

An excellent table rabbit is obtained from the first cross between a Belgian Hare doe and a Flemish Giant buck, and if only for this purpose, the Belgian breed is invaluable.

The Flemish Giant is so called on account of its size and heavy weight. While a Belgian Hare may weigh from 9 to 11 lb., a Flemish Giant doe will turn the scale at from 15 to 18 lb. For exhibition purposes, a dark, steel-grey colour is essential, and not black, as whole litters often are; the belly and underpart of the tail should be pure white.

The Angora is a very distinct breed, and on the Continent its long woolly hair has a commercial value. These rabbits cannot be kept clean unless the hair is regularly and systematically combed, which is a tedious operation. In colour they are either grey or fawn. Another variety that might be mentioned is the Himalayan.

The Dutch rabbit is the smallest of the domesticated breeds, averaging 5 or 6 lb. in weight. The colours of animals of this breed are very varied, and alternate between blue, black, grey, and yellow.

*Feeding*.—When for the market, feeding commences from birth, as it is then possible, in the case of the two first-mentioned breeds, to obtain a dressed carcase of from 3½ to 4 lb. in twelve or fourteen months. If well nourished by the doe they will become gradually weaned and leave the nest in from sixteen to twenty days, and freely partake of the ordinary dietary, provided it does not contain whole grain or an excess of cold succulent foods.

The morning meal may consist of chaffed clover hay, mixed with boiled potato peelings, or "chats", with which fine bran or sharps is incorporated to render the mass dry and not too sloppy. Steamed or pulped roots, with meal or chaffed hay or greenstuff, may be given according to whatever is available or in season.

TURKEYS, GEESE, GUINEA-FOWLS, AND RABBITS. 611

Serve all mashes warm, but not hot, and supply clean water to drink. Care must be taken not to give the sprouted shoots from mangels or other roots, as these are sweet, and will cause diarrhœa. Mature leaves of winter greens, swine-thistles, dandelion, plantain, chickweed, etc., may be given in moderation.

The lad who can attend rabbits with care and keep them clean and well housed, will usually exhibit similar care and attention when administering to the wants of the more important animals on the farm. Too much stress cannot be laid upon the importance of bran and dry food ; and an excess of green food often proves fatal.

## CHAPTER III.

### BEEES AND BEE MANAGEMENT.

BEE-KEEPING is an important adjunct to poultry-farming, as when properly carried out quite a reasonable remuneration can be obtained, especially in districts where wild and cultivated flowers are plentiful. Of the Honey Bee (*Apis mellifica*) there are many varieties, including the British Black Bee, Carniolan (Light or Banded Bee), Yellow Ligurian Bee, Syrian Bee, Tunisian, Palestinian, etc.

Through the honey season every colony that is in a healthy and normal condition will contain a queen, workers, and drones (Fig. 322). The queen is the ruler and mother of the hive, and without her presence the whole colony is disturbed. Her principal duty and function is to lay eggs, of which she can deposit from 2,000 to 3,000 in twenty-four hours. These eggs when kept warm, by the bees, produce tiny white grubs, which hatch in three days, and are fed on a half-digested mixture of polley, honey, and water, prepared in the stomachs of the workers. After six days the worker grub changes into a chrysalis, and in twelve more days the perfect bee is evolved. Drones are weaned on the fourth day, and require twenty-five days to mature, while the queen matures in five days less time than the workers, and it is well to remember that she leaves the cell eight days after being sealed in. In appearance the queen is larger than the other bees, has a tapering body, short wings, of a varying brownish colour, and possesses a sting, which she employs only when in conflict with other rival queens. The length of life of a queen is usually from two to three years.

The drones, or males, are hatched in the spring when virgin queens are to be mated, and at the end of the season the drones are expelled from the hive by the workers, except in the event of the hive becoming queenless or possessing an infertile queen. The appearance of drones in late autumn or early winter is therefore considered a bad sign. Drones are larger than the worker bees, have stronger wings, and make a loud humming sound when in flight. They are devoid of stings.

The workers, or labouring community of the hive, are really unsexed females, which, by being bred and reared in cells of restricted dimensions, and fed on short rations, have their reproductive organs undeveloped. Any newly-laid egg, or even grub, if not more than three days old, may be destined to become a queen or a worker at the will of the bees. The workers are smaller than the other inhabitants, and are provided with curved stings, which, when

used, are left embedded in the flesh, and the bee dies from the consequent rupture. In the summer the workers live for about six weeks, while those hatched in the autumn survive until the following spring.

Every lover of nature should make himself familiar with the life-history of bees, and study those contrivances with which Nature has provided them for the performance of their work. Bees store their honey, and "brood" in honeycomb, composed of layers of hexagonal cells placed as close together as security admits of. These slabs of cellular wax or honeycomb, are nearly 1 inch thick, the cells penetrating from either side to the mid-rib. Worker cells, for the reception of "brood" and honey, are about  $\frac{1}{4}$  in. in diameter, while the drone cells are about  $\frac{1}{2}$  in. across. Queen cells are distinct from either of these, being elongated, teat-shaped, and usually 1 inch in length, and  $\frac{1}{2}$  in. broad.

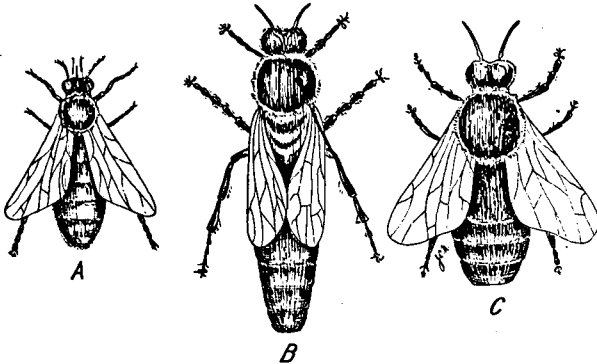

FIG. 322.—Bees. *A*, worker; *B*, queen; *C*, drone.

Those who are unfamiliar with frame hives should study their construction, and also their fittings and accessories; such as frames, crates, excluders, followers, sections, bee-escapes, feeders, embedder, smoker, quilts, etc., together with the methods adopted for fixing comb foundations (i.e. thin sheets of wax with the forms of cell bottoms impressed upon them).

**Subduing and Handling.**—In subduing and handling bees a gauze veil, proper gloves, and a smoker, are all that is required. Blow two or three good volumes of smoke into the entrance of the hive, and remove the quilt carefully by pulling it, laterally; then puff a little smoke across the top of the frames. Having provided a frame-box, remove the frames by taking hold of the lugs, and handling them so that no strain is placed upon that part of the comb least supported by the frame. After examination, place each frame in the frame-box, in such a position that they may be returned to the hive in

their former relative positions. If the bees are unduly irritated, due to abnormal heat or other cause, the work is better postponed until a more favourable opportunity presents itself.

Carbolic acid is useful in subduing, while it also acts as a powerful disinfectant. Owing to its caustic nature, however, it must be carefully handled, and diluted before use, as, in addition to burning the skin, it is highly poisonous.

**Swarming and Driving.**—Bees usually swarm in close warm weather, and when the hives become crowded, large numbers will be seen lying on the alighting board, all outside work having ceased. A swarm is occasioned by the departure of the older queen when she finds that a young queen has been hatched. As soon as the queen makes her exit, her followers rush from the hive in a body and rise into the air, their excited condition being manifested by loud humming. In due course the queen alights on a twig, when a cluster of bees immediately clings to her person, others following suit, until they form a pear-shaped mass often as large as a man's head. When ample time has been given for the swarm to settle, it should be secured by holding an inverted straw skep under it with the left hand, while the twig should be given a sharp jerk with the right hand, so that the swarm will fall into the skep in a mass, the floor-board being then placed over them. The skep is then turned the right way up and may be left on the ground near the tree, the floor-board being propped up so as to admit of any stragglers entering. The skep should be cool inside, and towards evening it may be removed to a cool spot, where a bar-framed hive is in readiness, with its comb foundations, quilts, and roof all ready to hand. Place a wide piece of board, covered with a white cloth, from the floor-board of the hive on to the ground. Now lift the skep carefully from its foot-board and shake the bees from it on to the middle of the cloth, when, as soon as they have recovered from the temporary shock, the queen will usually make her way up into the frame hive followed by the remainder of the bees. It may be necessary to raise a corner of the quilt of the hive for ventilation until the air becomes cool.

Before swarming, the bees gorge themselves with sufficient food to last them for four days, and are therefore usually docile, but some stocks are more vicious than others, particularly those which are cross-bred, and for this reason it is advisable to use a veil.

Strong healthy stocks usually throw off a second swarm or cast eight or ten days after the first. Early second swarms may be utilized as new stocks, or may go towards the strengthening of the parent stock, in which case they must be left beside it for twenty-four hours and the queen removed. All other and later casts are useless and even harmful.

It is evident that swarming must necessarily interfere with the collection of honey, besides weakening the parent stock. It is therefore sometimes necessary to prevent, or at least to discourage it; and this can be effected in several ways, but principally by ventilation of the hive, by supplying boxes of empty frames of foundations below the brood hive, by placing a sufficiency of shallow super frames above it, or by replacing brood and stores by frames of

foundations, while a common practice is that of cutting out or destroying the queen cells.

The driving of bees is a simple and easily effected operation, usually practised by those who keep straw skeps or box hives, which have to be cleared in order to secure the honey.<sup>1</sup>

**Uniting.**—In uniting swarms, the hives should be gradually brought together, and one of the two queens removed. If stores are short, feed the stocks with thin bee-syrup before uniting, after which remove all spare combs that are not covered with bees, from both hives. Place the frames in one of the hives, leaving sufficient space for a full frame of bees and honey between each pair of frames. Meanwhile, subdue both stocks of bees by smoke. Now quietly remove the brood combs from one hive to the other, placing them in the spaces left vacant for their reception. Fine pea-flour should be sprinkled over all the bees with a dredger, so that their change of companionship will be less noticeable, or, strongly scented peppermint syrup may be sprayed over them in preference to dusting them with flour.

**Queen Rearing.**—There is much in bee-keeping that can only be acquired by actual practice, and this is especially the case in the rearing of queen bees. A robust and prolific queen is essential in every hive, especially if a surplus of honey is to be obtained, as a worn-out or badly nourished queen can never produce the necessary workers; queens weaken in constitution after the second year. If the queen should be infertile, or lay only drone eggs, or if the hive be queenless, a new queen must be introduced or the stock will die out. The beginner can only hope to successfully introduce a queen by swarming, and when this is not possible he should consult an expert as to the best course, or failure in the establishment will be inevitable.

**Feeding and Wintering Bees.**—Throughout cold wet seasons, or when bees have been robbed of their stores, they will require feeding in early autumn with warm bee-syrup, prepared from pure cane sugar, and supplied by means of a rapid feeder. During the winter the hives must be kept watertight, and free from draughts, as, although bees will withstand a certain amount of dry cold, they soon sicken and die if subjected to damp. It may even be necessary to feed with thin syrup in early spring, preferably at night, through a bottle-feeder, to induce breeding. Care must always be taken in the handling of syrup and honeycomb, lest the bees be induced to commence robbing one another's hives, and especially is this so when feeding with honey, as its odour attracts marauders.

**Diseases.**—Foul brood, or bee pest, is a disease of a very contagious character, and is easily diagnosed by the cappings of the brood combs becoming sunk in and perforated, while the larvæ sicken, die, and

<sup>1</sup> The perfection to which handling bees is brought by experts is extraordinary. They lift them in handfuls, and appear devoid of nervousness. The expert is, however, particular not to allow any bee to feel confined or squeezed, as in a wrist-band, or under a sleeve. The bees must feel free, and any constraint causes them to use their stings. The temper of bees is also affected by thundery weather, and is best on sunny bright days. Bees are also better-tempered when full, and one result of smoking them is said to be that they at once begin to feed and thus become quieter and better-tempered.

finally decompose, emitting a foul stench. In the case of mild attacks a cure can often be effected by disinfecting the hive, by laying a cloth soaked in a one in seven solution of formalin on the floor-board of the hive, and by washing out each diseased cell with pure formalin by means of a small syringe, the larvæ then being removed and burnt. In bad attacks the whole infected stocks should be destroyed by burning, and the hive thoroughly fumigated and disinfected.

Isle of Wight disease has proved very disastrous among bee-keepers in the South of England, and no satisfactory cure has yet been prescribed, although prevention can be effected to some extent by careful disinfection.

Dysentery is another common disease among bees, and is largely attributable to dampness in the hive, and to unsealed, thin, or fermenting stores of honey. It can therefore be largely remedied by more comfortable housing, and by giving a liberal supply of sealed food, or, if in late autumn, by feeding with thin, warm, bee-syrup.

THE END.

## GENERAL INDEX.

- A**  
**ACIDIMETER** test in cheese-making, 466  
**Acidity** in milk, 465  
**Air**, action of, in drains, 35  
— aqueous vapour in, 29  
— carbon dioxide in, 29  
— composition of, 28  
— depth of, 13  
**Albuminoids**, 286  
**Ammonium sulphate**, 73  
**Annatto** in cheese-making, 469  
**Anther**, 514  
**Aptera**, 313  
**Arachnids**, 309  
**Armed palisade worm**, 305  
— symptoms and treatment, 305  
**Arthropods**, 308  
**Axles**, 347
- B**  
**BACTERIA**, 15  
— Barley cultivation, 104-5  
**Basic cinder**, 75  
— superphosphates, 77  
**Bean seed**, germination of, 492  
— structure of, 491  
**Beans**, 92-3  
**Bearings**, 347  
**Bees**, 612  
— diseases, 615  
— driving, 614  
— feeding, 615  
— handling, 613  
— life-history, 612  
— management, 614-16  
— queen rearing, 615  
— self-management, 612-13  
— subduing, 613  
— swarming, 614  
— taking by skep, 614  
— treatment, 615  
— uniting, 615  
— wintering, 615
- Beet** eelworm, 308  
**Beetles**, 313  
**Belgian hare**, 610  
"Black rot" of cabbages, turnips, etc., 569  
**Blackberries** and allied fruits, 530  
**Blight**, American, 301  
**Bolts**, 346  
**Bot-fly**, 323  
**Brackets**, 347  
**Brasses**, 348  
**Broody hens**, 592  
— signs of, 592  
— treatment of, 593  
**Broom rape**, 185  
**Bull breeding**, 225  
**Bumble bees**, 313  
**Bunt of wheat**, 571  
**Bush fruits**, 526  
**Butter**, churning of, 456  
— consistency of, 455  
— making, 453  
— utensils and water supply in, 453  
— marketing, 457  
— points in making, 453  
— salting, 456  
— temperature of cream for, 455  
— treatment of cream for, 455  
— of utensils for making, 455  
— working and making up, 456
- C**  
**CABBAGE**, 132  
— direct drilling in field for, 134  
— planting of, 134  
— seed-beds for, 133  
— "sporting" nature of, 135  
— uses of, 134



- Cabbage butterfly, large white, 318  
 Caerphilly cheese, 476  
 Cake-breakers, 389  
 Calcium cyanamide, 73  
 Calving or parturition, 227  
   — best time of year for, 229  
   — management in, 227, 228, 230  
 Cambium, 508  
 Camembert cheese, 484  
 Capillarity, 558  
 Carbon dioxide, 503  
 Carrot fly, 320  
 Carrots, 130  
 Carts and carriages, 380  
   — general purposes, 380  
 Cast iron, 348  
   — steel, 348  
 Casting and forging, 346  
 Cattle, classes of, 217  
   — general, 214-16  
   — management of, 217  
 Celery, 562-3  
 Centipedes, 309  
 Cereals, 96  
   — as wasters of nitrogen, 100  
   — continuous corn-growing, 100  
   — barley after wheat, 107  
   — exhausting nature of, 98  
   — harvesting of, 103  
   — origin of, 96  
   — render land foul, 98  
   — species and varieties of, 96-7  
 Cestodes or tape-worm, 302  
   — description, etc., of, 302  
   — symptoms of, 303  
 Chaff-cutter, 390  
 Chaff-steamer and molasses mixer, 391  
 Charlock, 185  
 Cheddar cheese, 471  
 Cheese-making, appliances for, 462  
   — boiler-house for, 462  
   — counties suitable for, 459  
   — dairies suitable for, 461  
   — drainage for, 461  
   — heat, light, and ventilation for, 461  
   — hoops for, 463  
   — mill for, 463  
   — presses for, 463  
   — rooms required, 461  
 Cheese-making, situation and aspect  
   — for, 461  
   — test for (Wisconsin), 466  
   — treatment of, 470  
 Cherries, packing of, 543, 564  
 Cheshire cheese, 473  
 Chicken coops, 585  
 Chicken-house, 585  
 Chicory, 154  
 Chlorophyll, 503  
 Clay, 8  
 Climate, 30  
   — as affected by aspect, 32  
   — contrasted with weather, 31  
   — moisture, 31-2  
   — shelter, 33  
 Clip fork stacker, 374  
 Clod-crushers, 363  
 Clover sickness, 575  
   — dressings for, 576  
 Clovers, red, 140  
   — Swedish or alsike, 141  
   — trefoil, 142  
   — white, 141  
 Club root or "finger and toe", 567  
 Coleoptera, 313  
 Colloids and compound particles, 14, 19  
 Colostrum, 436. *See also* Calving  
 Colwick or Slipcote cheese, 484  
 Composts, 61  
 Corn saw-fly, 313  
 Corn thrips, 324  
 Coulommier cheese, 485  
 Cowhouses, 427  
   — construction of, 429  
   — cost of, 429  
   — floor-space in, 434  
   — gutters in, 430  
   — light in, 432  
   — management of, 428  
   — mangers for, 430  
   — neck-fastenings of, 434  
   — partitions in, 431  
   — stalls and gangways, 433  
   — ventilation of, 433  
   — watering troughs for, 431  
 Cow-keeping for small-holders, 236  
   — cow-feeding for, 240  
   — cows best for, 238  
   — profits from, 239  
   — yields of milk, 239  
 Cream, analysis of, 447

- Cream, conditions affecting separation of, 452  
 — creamometers used for testing, 445  
 — deep setting of, 448  
 — Devonshire clotted, 448  
 — method of ascertaining percentage of butter fat in, 453  
 — separators, 449-51  
 — — auto-separator, 452  
 — — economy of, 451  
 — — points of, 451  
 — — setting of, 447  
 Cream cheese, 484  
 Cruciferous crops, 132  
 Cull ewes, 248  
 Cultivators, 361-3  
 Currants, 527
- DAIRY FARM, 419, 420**  
 — altitude for, 420  
 — aspect for, 420  
 — climate for, 420  
 — selection of, 420  
 — water supply, 421
- Dairying, 419  
 — buildings for a mixed farm, 419
- Dentition of cattle, 240  
 Derbyshire cheese, 473  
 Diets, 295, 297, 298, 300  
 Diptera, 319  
 Disassembling machine, methods of, 348  
 Dodder, 185  
 Dorset cheese, "blue vinney," 479  
 Drainage, effects of, 34, 36  
 — importance of, 35-6  
 — outfalls in, 37  
 Drains, rivers as, 37  
 — types of, 36  
 Drills, 366-7  
 Dry cows, treatment of, 226  
 Dry farming, 47  
 — details of cultivation, 47  
 — disced and undisced stubble illustrated, 47  
 — principles of, 48  
 Ducks, breeds of, 606  
 — Aylesbury, 607  
 — feeding of, 605  
 — Indian Runner, 607  
 — Pekin, 607  
 — Rouen, 607
- Ducks, Rouen, treatment of, 605-6  
 Dung spreader, 377
- FAR COCKLE, 307**  
 — Earthworm, 308  
 Eelworms, 108, 306  
 Electric power, 350  
 Elevator, portable, 374  
 Embryo-plant, 516  
 Embryo-sac, 515  
 Employees, number of, on farms, 395  
 Endosperm, 516  
 Engines, types of, 343  
 Ergot, 577  
 Escutcheons, types of, 425  
 Ewe flock, improvement of, 251  
 — — keep for, 257  
 — — management of, 247
- FALLOWING, 48, 111**  
 — Farm book-keeping, 411  
 — accuracy in, 411  
 — cash-book, 412  
 — cropping-book, 414  
 — dairy book, 414  
 — disadvantages of elaboration in, 415  
 — farm diary, 414  
 — farmer as book-keeper, 414  
 — granary and stores book, 414  
 — herd and flock books, 414  
 — labour and wages book, 413  
 — rules to be observed in, 412  
 — valuation of stock in, 412  
 — best time of year for, 413
- Farm buildings, 331  
 — adaptation of existing, 335  
 — cooking apparatus for, 338  
 — cost of erecting, 336-7.  
 — dairying for, 419, 427, 461  
 — designing of, 334  
 — dimensions of ordinary, 339  
 — drainage of, 335, 340  
 — extemporized, 335  
 — homesteads, 333  
 — hospital, 339  
 — implement shed, 339  
 — liquid manure in relation to, 338

- Farm buildings, manure in relation to, 338  
   — materials used in, 334, 340  
   — mud-walls for, 341  
   — points in construction of, 331, 337  
   — rickyard, 333  
   — stores, 338  
   — straw yard near, 336  
   — thatch for, 342  
   — typical plan of, 331-2  
   — unnecessary adjuncts to, 337  
   — weather-boarding for, 341  
   — weigh-bridge for, 340  
 Farm-yard manure, 57  
   — analytical composition of, 59  
   — apportionment of, 60  
   — compensation for foods used, 88  
   — for young clover, 60  
   — left on the surface, 60  
   — purchase of, 87  
   — weakest constituent of, 58  
 Farriery, 205  
 Fattening of cattle, 231  
   — feeding cattle, 233  
   — management of, 231-3  
   — merits of food for, 234  
 Feed-preparing machines, 387  
 Fertilization in plants, 516  
 Fertilizers, complications in using, 52  
   — leguminous crops as, 54  
   — soil exhaustion and, 50  
   — undue reliance on yard manure, 53  
 Flax, cultivation of, 167  
   — illustration of, 168  
 Flower culture, floriculture, 547  
   — artificial soils used in, 551  
   — bulbs, planting of, 549  
   — intensive cultivation in, 548  
   — localities suitable for, 547  
   — market gardening, 547  
   — marketing of, 565  
   — markets for, 548  
   — packing, methods of, 565  
   — plants suitable for, 550  
   — potting in, 549  
   — sowing of seeds in, 549  
   — trenching for, 553  
   —     — bastard, 554  
   — varieties suitable for, 548  
 Foals, food and feeding of, 194  
   — rearing of, 192  
 Foals, yearling, 193  
 Foods and feeding, 284  
   — accumulation of fat in animal body, 285  
   — age and condition in dieting, 298  
   — albuminoid poisoning in, 295  
   — cake and compound cake, 297  
   — carbo-hydrates in, 285  
   — chaff and cavings in, 292  
   — choice of, 296  
   — combustion of, 284  
   — comparative values of feeding stuffs, 296  
   — effects of bad feeding, 295  
   — enriching straw, 298  
   — fat in, 285  
   — flavour in, 296  
   — grass as a food, 287  
   — green fodder, 293  
   — green food *versus* cake, 294  
   — haulm in, 293  
   — hay in, 293  
   — market fluctuations in, 296  
   — mineral matter in, 287  
   — mixing foods for, 290  
   — nitrogen content in, 288  
   — nitrogen in, 288  
   — nutrient value of grasses, 288  
   — occult properties of pastures, 289  
   — oils in, 285  
   — pastures as food, 289  
   — plants found in pastures, 289  
   — potatoes as food, 294  
   — proteins in, 286  
   — "roots" as food, 291  
   — selective instincts of animals for herbage, 290  
   — straw as food, 291  
   — value of grasses as, 288  
   — waste in the body of, 285  
   — water in, 287  
   — winter feeding, suggestions for, 290  
 Foot, horse's, anatomy of, 205  
   — — diseases of, 210  
   — — illustrations of, 206-8, 212  
 Frame (machine), 346  
 Frit-fly, 108, 321  
 Fruit culture—  
   — budding of fruit-trees, 526

Fruit culture (*continued*)—  
 — commercial fruit culture, 523  
 — gathering of fruit, 542  
 — grading, 543  
 — grafting, 525-6  
 — — time of year for, 526  
 — grass orchards of fruit-trees, 540  
 — hardy fruits, 523  
 — — arrangement of plantation of, 538  
 — — — distances apart of trees in, 539  
 — — — names of, 544  
 — manuring of fruit-trees, 529  
 — — — correct time for, 530-1  
 — — — kinds of manures used in, 531  
 — marketing of fruit, 564  
 — prices of trees, 541  
 — propagation of, 525  
 — root pruning, 535  
 — — method of, 535  
 — — use of, 535  
 — selection of trees, 540  
 — — types for selection, 541  
 — shelter required for trees, 524  
 — soil and situation for trees, 522  
 — storage of fruits, 546  
 — — varieties suitable for, 547  
 — training of trees, 536  
 — wind-break for, 524

Fruit-trees, list of, 544  
 Fuel, 346

**G**AMETES or germ-cells, 514  
 Gape-worm of poultry, 306  
 Garden implements, 379  
 Geese, feeding of, 608  
 — treatment of, 608  
 — varieties of, 608  
 Gervais cheese, 486  
 Giant thread-worm, 305  
 Gid in sheep, 304  
 Gloucester cheese, 476  
 Goats, analysis of milk of, 267  
 — breeding of, 267  
 — breeds of, 266

Goats, feeding of, 267  
 — milk of, 267  
 Gooseberries, packing of, 543  
 Gooseberry mildew, 571  
 Gout-fly, 109, 321  
 Grain weevils, 316  
 Grass land, difficulties in laying down, 165  
 — effect of grazing on, 164  
 — basic cinder on, 165  
 — how best to make, 165  
 — mixed character of, 289  
 — *versus* arable land, 166  
 — woods in, 182, 184, 185  
 Grasses, 150  
 — cultivated, 150  
 — effects of climate and seasons on, 163  
 — fodder cereals, 150  
 — how to secure a plant, 158  
 — illustrations of, 151-65  
 — manuring of, 161  
 — migration of seeds, 162  
 — mixtures of, for seeding, 155  
 — pasture, 151-65  
 — rotation, 151  
 — sowing hay seeds, 156  
 Green-flies, 324  
 Grist mills, 388  
 Ground lime, 83  
 Growing for seed, 137  
 Guano not quite general, 67  
 Guinea-fowls, 609  
 Gun-metal, 348  
 Gypsum, 80

**H**ARD cheese-making, 458-79  
 — herbage in relation to, 459  
 — — poisonous plants in, 460  
 — — Lancashire method of, 475  
 — — milk, acidity in, 465  
 — — — heating of, 468  
 — — — normal, 435  
 — — — ripening of, 465  
 — — — supply of, 459  
 — — — treatment of, 464  
 — — natural starters in, 467  
 — — prices of cheese, 459  
 — — pure cultures in, 467  
 — — salt, 470  
 — — starters in, 467  
 — — whey in, 458  
 Harrows, 364-5.  
 Hartjen's pneumatic sprayer, 178  
 Harvest bug, 310

- Harvesting implements, 369  
 Hay loaders, 373  
 — presser, 377  
 — stackers or elevators, 374  
 — sweeps, 373  
 Hedge-laying, 406  
 Hedging and ditching, 405  
 Hemiptera, 324  
 Hessian fly, 319  
 Hoing, importance of, 121  
 Hoes, 379  
 Horned stock raising—  
 — counties suitable for, 217  
 — pasture in relation to, 214  
 — success with, 217  
 Horse bot-fly, 323  
 Horse labour, 395-6  
 — — cost of, 398  
 — — cost of maintenance, 399  
 — — cost per acre, 399  
 — — during harvest, 397  
 Horse-hoes, 368  
 Horse-rakes, 374  
 Horse-shoes, manufacture of, 207  
 Horses, 190  
 — agricultural, 190  
 — breaking of, 193  
 — breeding of farm, 190  
 — breeds of draught, 198  
 — dentition of, 200  
 — economy of horse-power in, 197  
 — farm team, management of, 194  
 — feeding times of, 196  
 — steam-power in relation to, 197  
 — working life of, 190  
 Humble bees, 313  
 Hymenoptera, 313
- I**CHNEUMON flies, 313  
 Implements, farm and garden, 356 et seq.  
 Incubation, artificial, 594  
 — natural, 592  
 Insects, 312  
 — classification of, 312  
 — life-history of, 312  
 Itch mites, 310
- K**AINIT, 78  
 Kale, 136  
 Knotter of binder, 370  
 Kohlrabi, 132
- L**ABOUR, cost of, per acre, 404  
 — effect of live stock on cost of, 395  
 — improved implements on cost of horse labour, 397  
 Lactometer, 446  
 Lambing, 255  
 — difficulties in connexion with, 256  
 — management of young lambs, 257  
 — pen, 255  
 Lambs, change of food for, 258  
 — keep, 257  
 Leaf structure, 504-5  
 Leather jackets, 319  
 Leguminous fodder crops, 138  
 Leicester cheese, 474  
 Lepidoptera, 317  
 Light tractor engines, 344  
 Lime, 80-4  
 Live stock, 189, 422  
 — as an aid to agriculture, 215  
 — fertility of land in relation to, 215  
 — grass land in relation to, 214  
 — judging of, 280  
 — market choice of, 422  
 — points to be observed in, 282  
 — selection of dairy, 422  
 — selection of suitable cows, 422  
 Liver fluke, 301  
 — life-history of, 301  
 — symptoms and treatment of, 301-2  
 Locking devices, 346  
 Loose smut in oats, 572  
 — remedy for, 572  
 — in barley, 572  
 — in wheat, 572  
 Lubricating, 349  
 Lucerne, 143
- M**ACHINERY, farm, generally, 356  
 Maize cultivation, 147  
 Mange in dogs, 311  
 — in horses, 310  
 Mangels and swedes, heart rot in, 569  
 Mangel-wurzel, 118  
 — after-cultivation of, 120  
 — cultivation of, 118

- Mangel-wurzel, manuring of, 120  
   — renovation of land by, 50  
   — seasons for sowing, 129  
   — storing of, 122  
   — types of, 119  
 Manual labour on a farm, 394  
   — — *versus* machine, 393  
 Manure distributors, 375  
   — drills, 376  
   — farm-yard, 57  
 Manures, exhaustion of the soil by,  
   50  
   — food, actual scale of  
     manurial values, 89  
   — — as a manurial agent,  
     88  
   — — valuation of manurial  
     residues, 88  
   — general, 57, 61  
   — green crop manuring, 65  
   — special, 69  
   — — alleged exhaustion  
     by, 70  
   — — classification of,  
     70  
   — — unit values of, 84  
 Mares, during pregnancy, 191  
   — management of brood, 191  
   — period of gestation of, 191  
   — service of, 191  
 Materials (machinery), 348  
 Mechanical power, 349  
 Mendelism, 518-22  
 Micropyle, 515  
 Mild steel, 348  
 Mildew in swedes, turnips, rape, etc.,  
   569  
 Milk, albumen in, 437, 446  
   — analysis of, 435, 446  
   — ash in, 437, 446  
   — bacteria in, 439  
   — casein in, 436, 446  
   — effects of heat on, 442  
   — fat in, 436, 443, 446  
   — filtering and cooling of, 440  
   — float, 380  
   — influences affecting quality and  
     yield of, 438  
   — — age of cow, 438  
   — — feeding of, 438  
   — — individuality, 438  
   — — lactation period, 438  
   — — milking of cow, 439  
   — — seasons affecting,  
     438  
   — — treatment of cow,  
     439  
 Milk, lactose in, 437, 446  
   — records, 427  
   — sugar in milk, 437; 446  
   — treatment of milk, 439  
   — water in, 436, 446  
   — yields of milk, 426  
 Milking, mechanical methods of, 440  
   — other methods of, 440  
 Millipedes, 309  
 Mites, 309  
 Mollusca, 326  
 Motors in agriculture, 355  
 Mowers, 371  
 Mussel scale, 326  
 Myriapods, 309  
  
**NEUROPTERA, 313**  
   Nitrate of lime, 73  
   Nitrate of soda, 72  
   Nitrification, 509  
     — bacteria in use in, 509  
 Nitrogen, assimilation of, by  
   legumes, 510  
   — fixation, 509  
   — nodules on roots of Legu-  
     minosæ, 511  
 Nitrolim, 73  
  
**OAT** cultivation, 108  
   Oats, diseases of, 108  
 Oil-engines, installation of, 353  
 Oil and petrol engines, 350-1  
   — advantages of, over  
     steam-engines, 352  
 Oosphere, 515  
 Orthoptera, 313  
 Osmosis, 500  
 Ovary, 514  
 Ovules, 514-15  
 Ox warble-fly, 322  
  
**PARASITES, kinds of, 301**  
   Parsnip fly, 320  
 Parsnips, 130  
 Pedigree cattle breeding—  
   — ages of heifers, 223  
   — art of, 218  
   — care of stock in, 225  
   — law of heredity, 220  
   — management of herds, 224  
   — new principles, 221  
   — systems of, 223  
 Peppercorns, 307  
 Phosphoric acid and phosphates, 74-7

- Photosynthesis, 501  
   — endosperm, 501, 516  
   — enzyme, 502  
   — light, 503  
   — proteins, 501  
   — water, 504
- Piecework, 400  
   — advantages of, 400  
   — carting out manure by, 401  
   — live stock, care of, by, 401  
   — prices of, 401  
   — tillages by, 400
- Pigs, age for mating, 272  
   — breeding of, 272  
   — breeds of, 271  
   — economy of, 269  
   — fattening of, 277  
   — fecundity of, 277  
   — feeding of fattening, 278  
   — feeding values of food for, 279  
   — food of, 279  
   — generality of, 278  
   — housing of, 270  
   — illustrations of, 273-5  
   — management of, 280  
   — old sows, 273  
   — percentage of offal in, 269  
   — period of gestation in, 273  
   — quality of meat of, 277  
   — "reckling," the, 276  
   — rules to be observed in fattening, 278  
   — selecting sows for breeding, 272  
   — size of litters, 274  
   — small-holder's, the, 269  
   — sows, as mothers, 274  
   — — general management of, 275  
   — — management of farrowing, 273  
   — store, 276  
   — weights and market prices of, 276  
   — young pigs, treatment of, 275-6
- Plant diseases, contributory causes to, 567  
   — danger of, 566-7  
   — delicacy of artificial systems, 566
- Plant lice, 324
- Plant life, 491-516  
   — breeding, 518
- Plant life, chemical analysis, 495-6  
   — food available for, 511  
   — genetics, 518  
   — germination, air required in, 495  
   — — condition necessary for, 494  
   — light for, 495  
   — temperature for, 495  
   — heredity, 516-22  
   — mutation, 517-18  
   — organs of, 491  
   — reproduction of flowering plants, 513  
   — respiration of, 501  
   — stem structure of, 506  
   — stigma, 515  
   — structure of (microscopic), 497  
   — variation in, 516-17
- Plough, parts of, 357-60  
   — setting of, 361
- Ploughing-engines, 344
- Plums, packing of, 544, 564
- Points of a cow, 215  
   — Ayrshire cow, 423-4  
   — dairy heifer, 422
- Pollen grains, 514  
   — tubes, 515
- Pont l'Evêque cheese, 486
- Portable engines, 343
- Potash, 77
- Potato drill, 368  
   — raisers, 385  
   — sorters or separators, 387
- Potatoes, 112  
   — blight, 573  
   — diseases of, 566-8, 573-5  
   — early, 113  
   — grading and storing of, 117  
   — planting and cultivation of, 113  
   — production and reproduction of, 113-14  
   — scab in, 574-5  
   — selection of seed of, 113  
   — soils suitable for, 113  
   — spraying, 117, 574  
   — trays for storing, 116  
   — winter rot of, 574
- Poultry, 581  
   — breeds of, 587  
   — — illustrations of, 583-93  
   — brooders for, 587, 598

- Poultry** (*continued*)—  
 commercial poultry-farming, 581  
 — corn and meal bins for, 586  
 — crammng machines for, 586  
 — crates for, 585-6  
 — dressing of, 600-1  
 — egg-boxes for farming, 586  
 — farming, equipment for, 583  
 — feeding, dry, 599  
 — — principles of, 586  
 — — wet, 598  
 — fertility of eggs, tests for, 593  
 — — time for testing, 593  
 — houses suitable for, 583-4  
 — intensive farming of, 581  
 — killing and plucking of, 599  
 — layers, 588  
 — management of, 581  
 — pails and baskets for, 586  
 — "peds" for, 586  
 — plucking of, 599  
 — points of exhibition fowls, 590  
 — preparation for table of, 599  
 — rearing of, 598  
 — selection of stock birds, 588  
 — sitting-boxes for, 584  
 — soil conditions in farming, 596  
 — table fowls, 589  
 — trussing of, for boiling, 602  
 — — for roasting, 630  
 Power, methods of transmitting, 347  
 Prickly comfrey, 149  
 Protozoa, 15  
 Pruning, 533  
 — art of, 533  
 — trees requiring, 534  
 Pulleys or sheaves, 347  
 Pyke-lifter, 374
- RABBITS**, breeds of, 610  
 — feeding of, 610  
 — litters of, 610  
 — period of gestation, 610  
 Rake, side-delivery type, 373  
 Ram lambs, 259  
 Rape, 136
- Raspberry, cultivation of, 528  
 — packing of, 544  
 — time of year for planting, 528  
 Reaper or mower, 371  
 Rennet, 466, 469  
 Root absorption, 507  
 — — selective, 513  
 — and shoot, 491  
 — — growth of, 498  
 — — structure of, 504, 506  
 — cleaner, 390  
 — crops, 111  
 — pulper, 390  
 — thinner, 378  
 Root-hairs, 500  
 Roses in pots, 552  
 — soils for, 552  
 Rotations of crops, 91  
 — catch-cropping, 95  
 — continuous cropping, 92, 100  
 — different lengths of, 92  
 — for two years, 93  
 — for three years, 93  
 — for four years, 93  
 — for five years, 93  
 — for six years, 94  
 — for eight years, 94  
 — for longer periods, 94  
 — theory of, 91  
 Rust fly, 320  
 Rye cultivation, 109
- SAINFOIN**, 145  
 — Salads, *see* VEGETABLES  
 Salt, common, 79  
 Sand, 9  
 Sarcoptic mange in horses, 310  
 Scale insects, 326  
 Seaweed as manure, 62  
 Seed dressers, 385  
 Seeding implements, 366  
 Seed-testing, 171  
 — age and ripeness of seed, 172  
 — analysis of seeds, 173  
 — apparatus for, 176  
 — illustrations of, 176-7  
 — importance of, 172  
 — laboratory for, 176  
 — numbers of seeds per lb., 174  
 — on porous dishes, 177  
 — sampling for, 175  
 — time required for, 174



- Self-binders, 369  
 Set-screw, 346  
 Shafts, spindles, 347  
 Shearing machines for, 266  
 Sheaves or pulleys, 347  
 Sheep, 243  
   — breeding of, 244  
   — breeds, illustrations of, 244-61  
   — cake and corn for, 259  
   — dentition of, 262  
   — dipping, 261  
   — drafting, 248  
   — fairs for, 247  
   — period of gestation of, 248  
   — mating time for, 248  
   — portable dippers for, 262  
   — sheep for small-holders, 260  
   — suitable counties for breeding of, 245  
   — tugs on turnips, management of, 259  
   — weaning time of, 257  
 Sheep nostril fly, 324  
 Sheep scab, 311  
 Sheep-shearing machines, 385  
 Shepherds' houses, 256  
 Shoeing, 209  
   — farm horses, methods of, 209  
   — hackney and carriage horses, 210  
   — hunters, 210  
   — preparation of foot for, 208  
 Slugs, 326-7  
 Soda, 78  
 Soft cheese-making, 480  
   — cloths, etc., for, 482  
   — drainage in, 481  
   — equipment for, 481  
   — making-room, 482  
   — mats, etc., for, 482  
   — pipettes, etc., for, 481  
   — principles of, 480  
   — ripening of, 482  
   — varieties of, 480, 483  
   — wooden tubs, 481  
 Soils, absorption of water by, 19  
   — air in, 35  
   — analysis of, 13  
   — available plant food in, 15  
   — chemical processes in, 508  
   — classification of, 25  
   — composition of, 5, 8  
   — constitution of, 13  
   — distribution of (geological), 20-5  
   — exhaustion of, by tillage, 14  
   — — — toxic principles in, 49  
   — — — and in fertilizers, 50-1  
   — fertility of, 512  
   — formation of, 4  
   — lime in, 9  
   — mineral fragments in, 10  
   — organic matter in, 14  
   — origin of, 8  
   — physical properties of, 18  
   — renovation of worn-out, 49, 50  
   — rest not necessary for, 49  
   — substances essential in, 512  
   — unreclaimed, 34  
   — vegetable matter in, 10  
   — virgin, 34  
   — water in, 35  
 Soot, 64  
 Spade, 378  
 Spiders, 309  
 Spraying, 177  
   — care of machines, 179  
   — dry, for potatoes (illustration), 179  
   — importance of, 177  
   — jets, syringes, etc., 177  
   — various mixtures, washes, and emulsions, 180-2  
   — wet, for charlock, 180  
 Spraying machines, 375  
 Stationary engines, 345  
 Steam ploughing and cultivating, 354  
 Steam-engines, 350  
 Steel, case-hardened, 348  
 Steers, management of, 230  
 Stem eelworm, 306  
 Stilton cheese, 477  
 Stock and horse men, 404  
 Straw, constituents of, 292  
 Strawberry-growing, 528  
   — soil suitable for, 528  
   — packing of, 543, 564  
*Strongylus filaria* and *S. rufescens*, 305  
 Studs, 346  
 Sturdy, staggers, or gid in sheep, 304  
 Subsoils, 11, 27  
 Sugar-beet, compared with mangel-wurzel, 124  
   — cultivation of, 125  
   — success of, in United Kingdom, 124

- Sulphate of ammonia, 73  
 Surface caterpillar, 318  
 Swath turners, 372  
     — — — and collectors, 373  
 Swede cultivation, 126  
 Symbiosis, 511
- T. ENI. A. cœnurus* and *T. eokino-*  
*coccus*, 304  
 Tape-worm, 302  
 Tedder or kicker, 372  
     — and side rake, 372  
 Thatching, 408  
     — — — laying of thatch, 410  
     — — — making a roof, 410  
     — — — pegging and cording,  
     410  
     — — — preparation of straw  
     for, 410  
 Thrashing-machines, 381-4  
 Thread-worms, 305  
 Thysanoptera, 324  
 Ticks, 309-10  
 Tillage—  
     — — — clay-burning, 39  
     — — — future of, 44  
     — — — implements, 357  
     — — — objections to deep, 41  
     — — — objects of, 39  
     — — — ordinary, 39-44  
     — — — over or excessive, 44  
     — — — paring and burning, 39  
     — — — ploughing by, 39  
     — — — root action as, 46  
     — — — spade, by, 45  
     — — — weathering, effects on, 45  
     — — — what it includes, 34  
 Tin, 348  
 Tobacco, after-cultivation of, 170  
     — — — cultivation of, 169  
     — — — harvesting and maturing  
     of, 171  
     — — — manuring of, 170  
     — — — raising seedlings, 170  
 Traction-engines, 343  
 Transmitting power, methods of,  
 347  
 Transpiration, 503, 557  
     — — — current, 503  
 Trees, choice of, 542  
     — — — methods of training, 537  
     — — — varieties of, 542, 544  
 Trematoda or flukes, 301  
 Trifolium, 139  
 Turkeys, 603  
     — — — feeding of, 604  
     — — — selection of stock, 603  
     — — — soil and situation suitable  
     for, 603  
     — — — treatment of young, 605  
     — — — varieties of, 603  
 Turnip flea beetle or fly, 315  
 Turnip saw-fly, 313  
 Turnips, white and yellow, 128
- U N A T T A C H E D labourers, 403  
     — — — operations performed  
     by, 403  
 Undertype engines, 345
- V E G E T A B L E S and salads, 559  
     — — — after-cultivation of, 561  
     — — — kitchen gardens for, 559  
     — — — manuring, care required  
     in, 559, 562  
     — — — kinds and quan-  
     tities suitable  
     for, 562  
     — — — of root crops of,  
     562  
     — — — marketing of, 563-5  
     — — — packing of, 563  
     — — — materials for, 563  
     — — — planting, months suitable  
     for, 561  
     — — — rotations for, reasons of,  
     559  
     — — — seed-bed for, 560  
     — — — seedlings, treatment of, 561  
     — — — sowing and planting,  
     months for, 561  
     — — — varieties included in, 560  
 Vetches, 138  
     — — — winter, 138
- W A G E S of agricultural labourers,  
     402  
     — — — variations in standard  
     wages, 403  
 Wagons, etc., 381  
 Warble fly, 322  
 Wart disease or black scab in  
 potatoes, 575  
 Waste products, 63  
 Water culture, 495, 497  
 Watering, 557  
     — — — effect of, 557-8  
     — — — Strawson's method of,  
     558

- Water-power, 356
- Weeds—
- illustrations of clover
  - dodder, 184
  - in arable land, 183
  - in cereal crops, 183
  - in pasture land, 182
  - parasitic, 185
- Wensleydale cheese, 478
- Wheat cultivation, 101-2
- eelworm, 307
  - midge, 319
  - rust and mildew in, 569
- Wheels, 348
- White mustard, 136
- Wind-power, 355
- Winnowing machines, 385
- Wire-worms, 314
- Wool, 265
- Woolly aphid, 325
- Wrought iron, 348
- Y**EARLINGS, management of, 230
- Yellow rattle (semi-parasitic), 185
- Z**OLOGY, economic, 301

# CROSBY LOCKWOOD & SON'S

LIST OF WORKS

ON

AGRICULTURE, FARMING,  
GARDENING, LAND  
AND ESTATE AGENCY,  
VALUATION, &c.

A Complete Catalogue of NEW and STANDARD WORKS on MECHANICAL, CIVIL, MARINE and ELECTRICAL ENGINEERING; MINING, METALLURGY and COLLIERY WORKING; ARCHITECTURE and BUILDING; The INDUSTRIAL ARTS, TRADES and MANUFACTURES; CHEMISTRY and CHEMICAL MANUFACTURES, &c. Post Free on Application.

LONDON  
7 STATIONERS' HALL COURT, LUDGATE HILL, E.C.  
AND  
5, BROADWAY, WESTMINSTER, S.W.

1914.

- ADMEASUREMENT OF LAND. A READY RECKONER.**  
By A. ARMAN. Revised and extended by C. NORRIS, Surveyor. Fifth Edition. Crown 8vo, cloth ... .. 2s.
- AGRICULTURAL ARITHMETIC.** A Practical Arithmetic for Estate Agents, Farmers, Agricultural, Horticultural and Dairy Students, and for use in Rural Schools. By J. C. NEWSHAM, F.L.S., Headmaster and Manager of the Hampshire County Council Agricultural and Horticultural School (Chairman Dairy Students' Union); Author of "The Horticultural Notebook"; and T.V. PHILPOTT, M.A. 264 pp. Crown 8vo, cloth ... .. *Just Published.* Net 3s. 6d.
- AGRICULTURAL FACTS AND FIGURES. A NOTE-BOOK FOR FARMERS AND FARM STUDENTS.** By PRIMROSE MCCONNELL, B.Sc., F.G.S., Fellow of the Highland and Agricultural Society. Author of "Elements of Farming." Eighth Edition. Fcap. 8vo, 490 pp., leather, gilt edges. ... .. Net 7s. 6d.
- AGRICULTURAL GEOLOGY, THE ELEMENTS OF.** A Scientific Aid to Practical Farming. By PRIMROSE MCCONNELL, Author of "Note-book of Agricultural Facts and Figures." 8vo, cloth. Net 21s.
- AGRICULTURAL SURVEYING.** A Treatise on Land Surveying, Levelling, and Setting-out; with Directions for Valuing and Reporting on Farms and Estates. By Professor J. SCOTT. Crown 8vo, cloth... .. 1s. 6d.
- AGRICULTURAL SURVEYOR AND ESTATE AGENT'S HANDBOOK** of Practical Rules, Formulæ, Tables, and Data. A Comprehensive Manual for the Use of Surveyors, Agents, Landowners, and others interested in the Equipment, the Management, or the Valuation of Landed Estates. By TOM BRIGHT, Agricultural Surveyor and Valuer, Author of "The Agricultural Valuer's Assistant," etc. Second Edition, thoroughly Revised and Enlarged. 464 pp. With Illustrations. Fcap. 8vo, leather ... .. Net 7s. 6d.
- AGRICULTURAL TENANCIES; A PRACTICAL HANDBOOK UPON.** For the use of Landlords, their Agents and Tenants. Together with the Text of the Agricultural Holdings Act, 1908 (English and Scottish), and the Small-Holdings and Allotments Act, 1908. By CHARLES EDWARD CURTIS, F.S.I., and ROBERT ABERCROMBY GORDON, M.A., LL.M. (Cantab.). 340 pp. Demy 8vo, cloth Net 10s. 6d.
- AGRICULTURAL VALUER'S ASSISTANT.** A Practical Handbook on the Valuation of Landed Estates; including Example of a Detailed Report on Management and Realisation; Forms of Valuations of Tenant Right; Lists of Local Agricultural Customs; Scales of Compensation under the Agricultural Holdings Acts, and a Brief Treatise on Compensation under the Lands Clauses Acts, etc. By TOM BRIGHT, Agricultural Valuer. Author of "The Agricultural Surveyor and Estate Agent's Handbook." Fifth Edition. Crown 8vo, cloth Net 6s.
- AGRICULTURE; EXTENSIVE AND INTENSIVE.** A Text-Book of Mixed Farming for Large and Small Farmers. By Professor JOHN WRIGHTSON, M.R.A.C., F.C.S. In conjunction with J. C. NEWSHAM, F.L.S., Headmaster and Manager of the Hampshire County Council Agricultural and Horticultural School. [*In Preparation.* Price about Net 7s. 6d.
- AGRICULTURE; THE FIELDS OF GREAT BRITAIN.** A Text-Book of Agriculture. Adapted to the Syllabus of the Science and Art Department. For Elementary and Advanced Students. By HUGH CLEMENTS (Board of Trade). Second Edition, Revised, with Additions. 18mo, cloth ... .. 2s. 6d.

- APPRAISER, AUCTIONEER, BROKER, HOUSE AND ESTATE AGENT AND VALUER'S POCKET ASSISTANT.** For the Valuation for Purchase, Sale, or Renewal of Leases, Annuities, and Reversions, and of Property generally; with Prices for Inventories, etc. By JOHN WHEELER, Valuer, etc. Re-written and greatly Extended by C. NORRIS. Seventh Edition. Royal 32mo, cloth ... .. 5s.
- AUCTIONEERS: THEIR DUTIES AND LIABILITIES.** A Manual of Instruction and Counsel for the Young Auctioneer. By ROBERT SQUIBBS, Auctioneer. Second Edition, Revised. Demy 8vo, cloth ... .. 12s. 6d.
- BARN IMPLEMENTS AND MACHINES.** Treating of the Application of Power to the Operations of Agriculture and of the various Machines used in the Threshing-barn, in the Stockyard, Dairy, etc. By Professor JOHN SCOTT. With 123 Illustrations. Crown 8vo, cloth 2s.
- BEEES FOR PLEASURE AND PROFIT.** A Guide to the Manipulation of Bees, the Production of Honey, and the General Management of the Apiary. By G. GORDON SAMSON. Third Edition, Revised and Enlarged; with a New Chapter on Beekeeping in Hot Climates. With numerous Illustrations. Crown 8vo, wrapper ... *Net* 1s.
- BOOK-KEEPING FOR FARMERS AND ESTATE OWNERS.** A Practical Treatise, presenting, in Three Plans, a System adapted for all classes of Farms. By J. M. WOODMAN, Chartered Accountant. Fourth Edition. Crown 8vo, cloth ... .. 2s. 6d.
- COCONUT CULTIVATION AND PLANTATION MACHINERY.** A Practical Handbook for Planters and Students. By H. L. COGHLAN and J. W. HINCHLEY. 140 pages. With Illustrations. Small Crown 8vo, cloth ... .. *Just Published.* 3s. 6d.
- CORN FACTOR'S GUIDE AND CALCULATOR.** Compiled for the purpose of showing at a glance the comparative cost of all kinds of Corn, Cake, Flour, and Seeds of every description, together with the Prices they should be sold at to obtain a Profitable Return on Sales. By E. WALTER HOW. Fcap. 8vo. Leather. ... .. *Net* 2s. 6d.
- DAIRY, PIGS, AND POULTRY.** By R. SCOTT BURN. Woodcuts. Crown 8vo, cloth ... .. 2s.
- DAIRYING, BRITISH.** A Handy Volume on the Work of the Dairy-Farm. For the Use of Students in Agricultural Colleges, Dairy Colleges, and Dairy Schools, and for Farmers, and Dairymen elsewhere. By Prof. J. P. SHELDON. With Illustrations. Third Edition, Revised. Crown 8vo, cloth ... .. 2s. 6d.
- DAIRYING (BRITISH AND COLONIAL), THE SCIENCE AND PRACTICE OF.** For School, Farm and Factory. By G. SUTHERLAND THOMSON, F.R.S.Ed., N.D.D., B.D.F.D., Prizeman, Agriculture, Aberdeen University and Glasgow Agricultural College, Author of "Milk and Cream Testing." 476 pages. Fully Illustrated. Demy 8vo, cloth ... .. *Just Published.* 9s.
- DAIRYING. MILK, CHEESE, AND BUTTER.** A Practical Handbook on their Properties and the Processes of their Production. Including a Chapter on Cream and the Methods of its Separation from Milk. By JOHN OLIVER, late Principal of the Western Dairy Institute, Berkeley. With Coloured Plates and 200 Illustrations. Crown 8vo, cloth 7s. 6d.

- DAIRYING INDUSTRY, THE.** Part. I. The Milk and Cream Supply—City, Farm and Factory. By G. SUTHERLAND THOMSON, F.R.S.E. With numerous Plates. Demy 8vo, cloth, 260 pp. *Net 10s. 6d.*
- DRAINING AND EMBANKING.** A Practical Treatise. By JOHN SCOTT, late Professor of Agriculture and Rural Economy at the Royal Agricultural College, Cirencester. With 68 Illustrations. Crown 8vo, cloth ... .. *1s. 6d.*
- EVERY MAN HIS OWN BUILDER.** A Book for Every Man who Owns a piece of Land, giving Concise Directions How to Build a House from the Foundations to the Roof. By G. GORDON SAMSON, Author of "How to Plan a House" and "Houses, Villas and Bungalows for Britishers and Americans Abroad." Second Edition, Revised. 352 pp., 292 Illustrations. Demy 8vo, cloth. ... *Net 5s.*
- FARM BUILDINGS;** Their Arrangement and Construction, with Plans and Estimates. By Professor J. SCOTT. Crown 8vo, cloth. *2s.*
- FARM ENGINEERING. A COMPLETE TEXT-BOOK.** Comprising Draining and Embanking, Irrigation and Water Supply, Farm Roads, Fences and Gates, Farm Buildings, Barn Implements and Machines, Field Implements and Machines, Agricultural Surveying, etc. By Professor JOHN SCOTT. In One Vol., 1,150 pp., half-bound, with over 600 Illustrations... .. *12s.*
- FARM GAS ENGINES.** By H. R. BRATE. 200 pp., with 36 Illustrations. Crown 8vo, cloth ... .. *Net 4s. 6d.*
- FARM MANAGEMENT.** Treating in outline of the General Work of the Farm; Stock; Contract Work, Labour, etc. By R. SCOTT BURN. Crown 8vo, cloth ... .. *2s. 6d.*
- FARM ROADS, FENCES AND GATES.** A Practical Treatise on the Roads, Tramways, and Waterways of the Farm; the Principles of Enclosures; and on Fences, Gates, and Stiles. By Professor JOHN SCOTT. Crown 8vo, cloth ... .. *1s. 6d.*
- FARMERS', GRAZIERS', AGRICULTURAL STUDENTS', SURVEYORS', LAND AGENTS', AUCTIONEERS', etc., TABLES AND MEMORANDA.** With a New System of Farm Bookkeeping. By SIDNEY FRANCIS. Fifth Edition. 272 pp., waistcoat-pocket size, limp leather ... .. *1s. 6d.*
- FARMING AND FARMING ECONOMY.** Historical and Practical. By R. SCOTT BURN. Crown 8vo, cloth ... .. *3s.*
- FARMING, MODERN, OUTLINES OF.** By R. SCOTT BURN. Soils, Manures, and Crops—Farming and Farming Economy—Cattle, Sheep, and Horses—Management of Dairy, Pigs, and Poultry—Utilisation of Town Sewage, Irrigation, etc. 1,250 pp., half-bound, profusely Illustrated ... .. *12s.*
- FARMING, PRACTICAL.** In Relation to Soils, Manures, and Crops, with a Chapter on Homestead Construction, including a Number of Plans and Sections. By EDMUND T. SHEPHERD, Professional Associate of the Surveyors' Institution. Demy 8vo, cloth *Net 4s. 6d.*
- FARMING, SYSTEMATIC SMALL;** or, the Lessons of My Farm. Being an Introduction to Modern Farm Practice for Small Farmers. By R. SCOTT BURN, Author of "Outlines of Modern Farming," etc. Crown 8vo, cloth ... .. *6s.*

- FERTILISERS AND FEEDING STUFFS.** Their Properties and Uses. A Handbook for the Practical Farmer. By BERNARD DYER, D.Sc., F.I.C. With the Full Text of the Fertilisers and Feeding Stuffs Act of 1906, the Regulations and Forms of the Board of Agriculture, and Notes on the Act by A. J. DAVID, B.A., LL.M. Sixth Edition, Revised. 160 pages, crown 8vo, cloth ... .. *Net 1s.*
- FIELD IMPLEMENTS AND MACHINES;** With Principles and Details of Construction and Points of Excellence, their Management, etc. By Professor JOHN SCOTT. With 138 Illustrations. Crown 8vo, cloth ... .. **2s.**
- FORCING GARDEN;** or, How to Grow Early Fruits, Flowers, and Vegetables. With Plans and Estimates for Building Glass-houses, Pits, and Frames. With Illustrations. By SAMUEL WOOD. Crown 8vo, cloth ... .. **3s. 6d.**
- FORESTRY, PRACTICAL;** and its Bearings on the Improvement of Estates. By CHARLES E. CURTIS, F.S.I., Professor of Forestry, Field Engineering, and General Estate Management, at the College of Agriculture, Downton. Third Edition, Revised and Enlarged. Crown 8vo, cloth ... .. *Net 3s. 6d.*
- FORESTRY; COMPLETE YIELD TABLES FOR BRITISH WOODLANDS AND THE FINANCE OF BRITISH FORESTRY.** By P. TRENTHAM MAW, P.A.S.I., a member of the Land Agents' Society, &c. 120 pp. Royal oblong 8vo, cloth. ... .. *Net 7s. 6d.*
- FRUIT TREES. THEIR SCIENTIFIC AND PROFITABLE CULTURE.** From the French of M. DU BREUIL. Sixth Edition, carefully Revised by GEORGE GLENNY. With 187 Woodcuts. Crown 8vo, cloth ... .. **3s. 6d.**
- GARDEN RECEIPTS.** Edited by CHARLES W. QUIN. Fourth Edition. Crown 8vo, cloth ... .. **1s. 6d.**
- GARDENING (COTTAGE);** or, Flowers, Fruits, and Vegetables for Small Gardens. By E. HOBBDAY. Crown 8vo, cloth ... .. **1s. 6d.**
- GARDENING (KITCHEN) MADE EASY.** Showing the best means of Cultivating every known Vegetable and Herb, etc., with directions for management all the year round. By GEO. M. F. GLENNY. Illustrated. Crown 8vo, cloth ... .. **1s. 6d.**
- GARDENING, MARKET AND KITCHEN.** By C. W. SHAW. Crown 8vo ... .. **3s. 6d.**
- GARDENING, MULTUM-IN-PARVO;** or, How to Make One Acre of Land Produce £620 a year, by the Cultivation of Fruits and Vegetables; also, How to Grow Flowers in Three Glasshouses, so as to realise £176 per annum clear profit. By SAMUEL WOOD, Author of "Good Gardening," etc. Seventh Edition. Crown 8vo, sewed ... .. **1s.**
- GOOD GARDENING. A PLAIN GUIDE;** or, How to Grow Vegetables, Fruits, and Flowers. By S. WOOD. Fifth Edition With considerable Additions and numerous Illustrations. Crown 8vo, cloth... .. **3s. 6d.**
- GRAFTING AND BUDDING.** By CHARLES BALTET. With Illustrations. Crown 8vo, cloth... .. **2s. 6d.**



**GRAZING. THE COMPLETE GRAZIER, AND FARMERS' AND CATTLE BREEDERS' ASSISTANT.** A Compendium of Husbandry. Originally written by WILLIAM YOUATT. Considerably Enlarged, and mainly Re-written in 1893 and 1903 by WILLIAM FREAM, LL.D., Assistant Commissioner, Royal Commission on Agriculture, 1893. Fifteenth Edition, thoroughly Revised and brought up to the Present Requirements of Agricultural Practice, by WILLIAM E. BEAR, formerly Editor of *The Mark Lane Express*. Super Royal 8vo, 1,100 pp., 450 Illustrations, handsomely bound £1 11s. 6d.

BOOK I. ON THE VARIETIES, BREEDING, REARING, FATTENING AND MANAGEMENT OF CATTLE—BOOK II. ON THE ECONOMY AND MANAGEMENT OF THE DAIRY—BOOK III. ON THE BREEDING, REARING AND MANAGEMENT OF HORSES—BOOK IV. ON THE BREEDING, REARING AND FATTENING OF SHEEP—BOOK V. ON THE BREEDING, REARING AND FATTENING OF SWINE—BOOK VI. ON THE DISEASES OF LIVE STOCK—BOOK VII. ON THE BREEDING, REARING AND MANAGEMENT OF POULTRY—BOOK VIII. ON FARM OFFICES AND IMPLEMENTS OF HUSBANDRY—BOOK IX. ON THE CULTURE AND MANAGEMENT OF GRASS LANDS—BOOK X. ON THE CULTIVATION AND APPLICATION OF GRASSES, PULSE AND ROOTS—BOOK XI. ON MANURES IN GENERAL AND THEIR APPLICATION TO CROPS—BOOK XII.—MONTHLY CALENDARS OF FARM-WORK THROUGHOUT THE YEAR.

**HAY AND STRAW MEASURER;** New Tables for the Use of Auctioneers, Valuers, Farmers, Hay and Straw Dealers, &c. By JOHN STEELE. Crown 8vo, cloth ... .. 2s.

**HORTICULTURAL NOTE-BOOK.** A Manual of Practical Rules, Data, and Tables, for the Use of Students, Gardeners, Nurserymen, and others interested in Flower, Fruit, and Vegetable Culture, or in the Laying-out and Management of Gardens. By J. C. NEWSHAM, F.R.H.S., of the Hampshire C. C. Horticultural School. With numerous Illustrations. Second Edition. Fcap. 8vo, cloth *Net* 4s. 6d.

**HOUSE PROPERTY;** Handbook of: a Popular and Practical Guide to the Purchase, Mortgage, Tenancy, and Compulsory Sale of Houses and Land, including Dilapidations and Fixtures, with Examples of all kinds of Valuations, Information on Building and on the right use of Decorative Art. By E. L. TARBUCK, Architect and Surveyor. Seventh Edition. 12mo, cloth ... .. 5s.

**INTEREST CALCULATOR.** Containing Tables at 1, 1½, 2, 2½, 3, 3½, 4, 4½, 4¾, and 5 per cent. By A. M. CAMPBELL, Author of "The Concise Calendar." Crown 8vo, cloth ... .. *Net* 2s. 6d.

**INWOOD'S TABLES FOR PURCHASING ESTATES AND FOR THE VALUATION OF PROPERTIES.** Including Advowsons, Assurance Policies, Copyholds, Deferred Annuities, Freeholds, Ground Rents, Immediate Annuities, Leaseholds, Life Interests, Mortgages, Perpetuities, Renewals of Leases, Reversions, Sinking Funds, etc., etc. 30th Edition, Revised and Extended by WILLIAM SCHOOLING, F.R.A.S. 366 pp., Demy 8vo, cloth ... .. *Net* 8s.

**IRRIGATION AND WATER SUPPLY.** A Practical Treatise on Water Meadows, Sewage Irrigation, Warping, &c.; on the Construction of Wells, Ponds, and Reservoirs, &c. By Professor J. SCOTT. Crown 8vo, cloth ... .. 1s. 6d.

**IRRIGATION, PIONEER.** A Manual of Information for Farmers in the Colonies. By E. O. MAWSON, M.Inst.C.E., Executive Engineer, Public Works Department, Bombay. With Chapters on Light Railways by E. R. CALTHROP, M.Inst.C.E., M.I.M.E. With Plates and Diagrams. Demy 8vo, cloth ... .. *Net* 10s. 6d.

- LAND VALUER'S BEST ASSISTANT.** Being Tables on a very much Improved Plan, for Calculating the Value of Estates. With Tables for Reducing Scotch, Irish, and Provincial Customary Acres to Statute Measure, etc. By R. HUDSON, C.E. New Edition. Royal 32mo, leather, elastic band ... .. 4s.
- LANDED ESTATES MANAGEMENT.** Treating in Outline the Varieties of Lands, Methods of Farming, the Setting-out of Farms, etc.; Roads, Fences, Gates, Irrigation, Drainage, etc. By R. S. BURN. Crown 8vo, cloth ... .. 2s. 6d.
- LAW FOR FARMERS, LAND AGENTS, &c.** See EVERY MAN'S OWN LAWYER. A Handybook of the Principles of Law and Equity. By a Barrister. Fifty-first (1914) Edition, Revised and Enlarged. Including Abstracts of the Legislation of 1913. Containing also many Acts of especial interest to Farmers and Land Owners. Large Crown 8vo, 850 pp. ... [Published Annually. Net 6s. 8d.]
- MEAT PRODUCTION;** A Manual for Producers, Distributors, and Consumers of Butchers' Meat. By J. EWART. Crown 8vo. 2s. 6d.
- MILK AND CREAM TESTING AND GRADING DAIRY PRODUCTS FOR SCHOOL, FARM, AND FACTORY.** By G. SUTHERLAND THOMSON, F.R.S.Ed., late Government Dairy Expert, South Australia. With an Introduction by SAMUEL LOWE. 224 pp., with Illustrations. Crown 8vo, cloth Net 4s. 6d.
- MILLERS', CORN MERCHANTS', AND FARMERS' READY RECKONER.** Second Edition, revised, with a Price List of Modern Flour Mill Machinery. By W. S. HUTTON, C.E. Crown 8vo, cloth ... .. 2s.
- OIL PALM CULTIVATION.** Some Essential Notes. By FRANK MARSHALL MILLIGAN, F.R.G.S., Plantation Expert in the Congolese Section of the French West African Colony and the Gold Coast. 112 pages, with Illustrations. Small Crown 8vo, cloth. *Just Published. Net 2s. 6d.*
- INTRODUCTION—SOME NOTABLE OPINIONS ON WEST AFRICA—WHAT THOSE OPINIONS OVRLOOKED—ELÆIS GUINEENSIS—LIFE AND CHARACTERISTICS OF THE OIL PALM—FRUIT OF THE OIL PALM—THE SEED OF THE OIL PALM—MANURES—DISEASES OF THE OIL PALM—DISEASES OF THE OIL PALM ROOTS—THE FORMATION OF AN OIL PALM PLANTATION—CULTIVATION OF THE OIL PALM—ECONOMIC WAY OF HARVESTING—PERMANENT PLANTATION BUILDINGS—CATCH DROPS.
- PROPAGATION AND PRUNING OF HARDY TREES, SHRUBS AND MISCELLANEOUS PLANTS.** With Chapters on Manuring and Planting. By J. C. NEWSHAM, F.L.S., Headmaster and Manager of the Hampshire County Council Agricultural and Horticultural School, Author of "The Horticultural Notebook." 238 pp., with 57 full-page Illustrations. Demy 8vo, cloth. *Just Published. ... Net 6s.*
- RATING AND ASSESSMENT, THE LAW AND PRACTICE OF.** A Handbook for Overseers, Members of Assessment Committees, Surveyors, and others interested in Rating and Valuation. By CLARENCE A. WEBB, P.A.S.I., Author of "The Valuation of Real Property," &c. 258 pages, Demy 8vo, cloth. ... .. Net 7s. 6d.
- ROTHAMSTED EXPERIMENTS AND THEIR PRACTICAL LESSONS FOR FARMERS.** Part I. STOCK. Part II. CROPS. By C. J. R. TIPPER. Crown 8vo, cloth ... .. 3s. 6d.
- RUBBER (PARA); ITS CULTIVATION AND PREPARATION.** By W. H. JOHNSON, F.L.S., Director of Agriculture, S. Nigeria, West Africa. Second Edition. Re-written and greatly Enlarged. 192 pages, with numerous Illustrations. Demy 8vo, cloth. *Net 7s. 6d.*

- RUBBER PLANTER'S NOTE-BOOK.** A Handy Book of Reference on Para Rubber Planting. With Hints on the Maintenance of Health in the Tropics. By F. BRAHAM, F.R.G.S. With Diagrams and Photographs. 116 pp. Fcap. 8vo, cloth ... .. *Net 2s. 6d.*
- SEWAGE, IRRIGATION, &c.** By R. SCOTT BURN. Woodcuts. Crown 8vo, cloth ... .. *2s. 6d.*
- SHEEP; The History, Structure, Economy, and Diseases of.** By W. C. SPOONER. Crown cloth, 8vo ... .. *3s. 6d.*
- SOILS, MANURES, AND CROPS.** By R. SCOTT BURN. Woodcuts. Crown 8vo, cloth ... .. *2s.*
- STOCK; CATTLE, SHEEP, AND HORSES.** By R. SCOTT BURN. Woodcuts. Crown 8vo, cloth ... .. *2s. 6d.*
- TREE PLANTER AND PLANT PROPAGATOR.** With numerous Illustrations of Grafting, Layering, Budding, Implements, Houses, Pits, etc. By S. WOOD. Crown 8vo, cloth ... .. *2s.*
- TREE PRUNER; Being a Practical Manual on the Pruning of Fruit Trees, including also their Training and Renovation, also treating of the Pruning of Shrubs, Climbers, and Flowering Plants.** By SAMUEL WOOD, Author of "Good Gardening," etc. Crown 8vo, cloth *1s. 6d.*
- THE TREE PLANTER, PROPAGATOR, AND PRUNER.** Being the above two works bound together ... .. *3s. 6d.*
- TROPICAL AGRICULTURE, ELEMENTARY.** A Handbook for Students and Planters. By W. H. JOHNSON, F.L.S., Director of Agriculture in Southern Nigeria, Author of "The Cultivation and Preparation of Para Rubber," etc. 162 pages. Illustrated. Demy 8vo, cloth [*Just Published.* *Net 3s. 6d.*]
- VALUATION OF MINERAL PROPERTY.** Rules and Tables. By T. A. O'DONAHUE, M.E., F.G.S., M.I.M.E.; Editor of "Mining Engineering"; First Class Certificated Colliery Manager; Author of "Mining Calculations," 166 pages. Demy 8vo, cloth *Net 7s. 6d.*
- VALUATION OF REAL PROPERTY; A Guide to the Principles of Valuation of Land and Buildings, etc., for various Purposes, including the Taxation of Land Values.** With numerous examples. By CLARENCE A. WEBB, Valuer and Rating Surveyor, P.A.S.I.; Author of "The Law and Practice of Rating and Assessment," "Rates and Taxes." Third Edition, Revised and Enlarged. 340 pp. Demy 8vo, cloth ... .. *Net 7s. 6d.*
- VALUATION OF REAL PROPERTY; Notes on; Containing Examples of Valuations of Freehold and Leasehold Properties.** By H. G. LAMPUTT, A.A.I. Cn. 8vo, cloth [*Just Published, Net 1s. 6d.*]
- VALUATION, TABULAR AIDS TO.** For Ascertaining the Purchase Price of Building Estates, Percentage required to cover Interest and Sinking Fund, Cost of Buildings, etc. By GEO. T. MCCAIG, B.A.I., M.A. and F. OLIVER LYONS, B.A.I., M.A. Crown 8vo, cloth. *Net 5s.*
- WOODMAN'S YEARLY FARM ACCOUNT-BOOK** Giving Weekly Labour Account and Diary, and showing the Income and Expenditure under each Department of Crops, Live Stock, Dairy, etc. etc. With Valuation, Profit and Loss Account, and Balance-sheet at the End of the Year. By JOHNSON M. WOODMAN, Chartered Accountant Third Edition. Revised. Folio, half-bound ... .. *Net 7s. 6d.*